

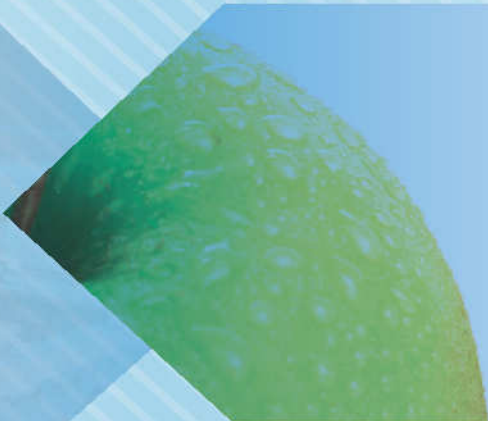

 GENERAL Catalogue



**EMERSON**  
Climate Technologies



# INDEX

<b>THE COMPANY</b>	<b>4</b>
<b>APPLICATIONS</b>	<b>6</b>
<b>RANGE</b>	<b>8</b>
<b>CORPORATE and HOMOLOGATIONS</b>	<b>10</b>
<b>PRODUCTS</b>	<b>11</b>
<b>GENERAL PURPOSE REFRIGERATION CONTROLLERS</b>	<b>11</b>
THERMOMETER – temperature display	12
PRIME CX – NT and LT applications	14
PRIME D – NT and LT applications	20
UNIVERSAL-R – heating applications, NT and LT – 7 pre-configured maps	22
WING – NT and LT applications – compact/split format	26
<b>MULTIPLEXED CABINET REFRIGERATION CONTROLLERS</b>	<b>35</b>
XM200/400/600 – NT and LT multiplexed applications	36
<b>ELECTRONIC EXPANSION VALVE DRIVERS</b>	<b>43</b>
XEV – superheat regulation	44
<b>ROOM CONTROLLERS</b>	<b>47</b>
XLR100 COOL MATE – NT and LT applications	48
XLR400 COOL MATE – NT and LT applications with dual temperature management	50
XLH200/300 COOL MATE – NT and LT applications and maturing rooms with temperature/humidity management	52
V-KIT – NT and LT applications – split format	54
<b>CONTROLLERS for SPECIAL REFRIGERATED APPLICATIONS</b>	<b>55</b>
XRb – bottle cooler applications	56
XB500 – blast chiller and temperature maintenance applications	58
XH200/300 – NT and LT refrigerated and maturing room applications with temperature/humidity management	60
XR400 – NT and LT applications with dual temperature management	64
XR700 – NT and LT applications with HACCP function	66
XDL – temperature and status recording	68
XW700 – pharmaceutical applications	70
XR20/60 & XW20/60/300 – NT and LT refrigerated truck applications	72



<b>COMPRESSOR RACK REFRIGERATION CONTROLLERS</b>	<b>75</b>
XEV02 – Digital™ compressor applications	76
XC10/30 – condensing unit applications	78
XC400/600 – up to 6 compressor/fan output applications also with inverter management	80
XC1000 – up to 15 compressor/fan output applications	84
iProRACK – up to 2 circuit and 6 compressor per circuit applications	90
<b>FAN SPEED CONTROLLERS</b>	<b>93</b>
XV300 – three-phase fan speed control	94
XV05/10/22/100 – single-phase fan speed control	96
<b>TEMPERATURE/HUMIDITY/PRESSURE CONTROLLERS</b>	<b>99</b>
XT100 – NTC, PTC, Pt100, TcJ, TcK, TcS, 4÷20mA, 0÷1V, 0÷10V multi-probe input	100
<b>GENERAL PURPOSE PROGRAMMABLE CONTROLLERS</b>	<b>105</b>
XEV20 – stepper electronic expansion valves management	106
iProGENIUS – general applications – high connectivity	108
<b>GENERAL PURPOSE TOUCH SCREEN DISPLAY</b>	<b>117</b>
TGIPG – high programmability	118
<b>SYSTEMS</b>	<b>121</b>
XWEB300D – alarm management and controlling	124
XWEB500 - XWEB500D – monitoring and controlling	126
XWEB3000 – industrial monitoring and controlling	128
XWEB5000 – monitoring, controlling and supervising	130
iCOOLL – wireless solution	137
XJM – I/O management	138
XJA-XJP-XJR – relay and acquisition management	140
XCENTER – centralized management	142
<b>PROBES</b>	<b>145</b>
<b>ACCESSORIES</b>	<b>153</b>
<b>DIMENSIONS &amp; CUT OUT</b>	<b>162</b>
<b>GENERAL TECHNICAL FEATURES</b>	<b>167</b>



## THE COMPANY



### HEADQUARTERS

**Dixell**, situated in Pieve d'Alpago (Belluno) and now part of the **Emerson Climate Technologies Group**, is a dynamic Company that from the year 1996 to present has positioned itself among world leaders of electronic Regulation and Control in **Industrial and Commercial Refrigeration, Conditioning and Cooking** fields thanks to continuous **Technologic Innovation** and a **focus on Energy Saving** issues.



### SALES, TRAINING

Worldwide, our products are distributed and supported in **over 70 countries**, by a sales network of experienced and **qualified personnel**, guaranteeing the correct selection of controllers and an efficient after sales service. Competence, professionalism, and courtesy make our Customer Service Dept exemplary. It provides our distributors and customers alike with technical support, solutions and concise answers to issues that may arise. Constant **technological development and innovation** of our products make us stand out in the market as the strategic choice for most users. This and the continuous growth of our product range requires constant training for our own staff and our distributors. To meet this challenge a fully equipped training facility with the most advance computer technology has been developed at our Belluno base.



### IPro ACADEMY

A center of excellence that combines innovation requests received from the HVAC/R market combined with technological opportunities, in this way guaranteeing continuous **iPro programmable platform** growth.



## RESEARCH, DEVELOPMENT, PRODUCTION

Continuous **research and development** means that all of our controllers feature the latest generation of microprocessors. Giving due consideration to the actual needs of many users has led us to develop Dixell's fast and simple programming methods. Most operating features are carefully developed through listening closely to the requirements of our many users. Our "Research and Development" and our "Production" departments are highly flexible, which means they can respond quickly to specific customer requirements and offer appropriate solutions, now even more competitive and flexible thanks to China bases. Highly sophisticated equipment is now employed in the development and control of manufacturing. Here delicate and repetitive tasks are mostly carried out by "state of the art" **automatic systems**.



## QUALITY

Dixell has been awarded with **ISO9001 certificate** and it constantly commits itself to quality in everything it does. The quality system of Dixell conforms to the Quality System Standard **UNI EN ISO 9001:2008**.



## ENVIRONMENT

Dixell firmly believes in the **respect and safeguard of the environment**, with particular attention to all industrial processes and to the research and development of new products.

Dixell's strengths are the realization of regulators that combine high performance with high **energy savings** and the use of eco-friendly components, in full compliance with all Italian and International laws and standards. To this end Dixell complies with the Material Compliance Program of Emerson respecting the **RoHS** directive (**2002/95/EC**) and the **REACH** regulation (**CE n. 1907/2006**), asking its suppliers accurate analysis on all purchased components. Furthermore packing materials are in accordance with **2004/12/CE European Directive**.



# APPLICATIONS



## REFRIGERATION

**Refrigeration** requires the control of many different conditions to guarantee that products are processed and stored correctly. Temperature, pressure and humidity must be monitored with reliable devices that are also simple to manage. Whether we are dealing with a **compressor rack controller** or the **smallest refrigerator** or **refrigerated transport**, controllers must provide total solutions that provide complete control.

Often, hidden behind a **bottle cooler** or **pharmaceutical cabinet**, lies the electronic technology which is nowadays required, which is becoming more important and plays a decisive role, both for the designer and for the consumer. The concepts of integration, remote access, energy savings, functional aesthetics and connectivity are important considerations on which even the **wholesaler** can always rely on. Even regarding **catering** and **food service**, Dixell has years of experience in offering products with excellent performance and durability including special applications such as **blast chiller** processes used in freshly-cooked food conservation. Dixell's solutions to the introduction of food hygiene regulations (HACCP) offer immediate advantages in terms of cost, time and system operation.

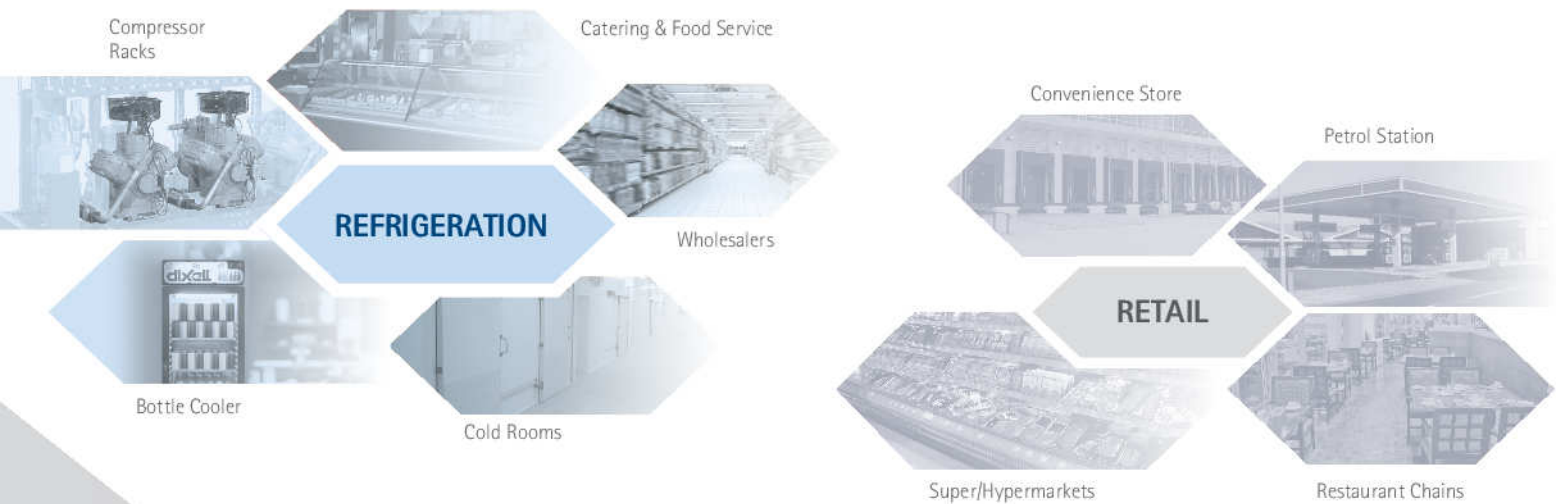



## RETAIL

The complete solution that Dixell offers for the Retail field is a solution for every kind of application, from **petrol station** to **hypermarket** up to **convenience stores**. If there is an alarm, it is necessary to be advised quickly in order to intervene without delay. Depending on the application, Dixell provides remote assistance systems for local monitoring, for supervising or remote control including via Internet. Where there are many points of sale, such as **restaurant chains** or **distribution centers**, centralized management software for the Call Center is available.



## CONTRACTING

Experience, combined with innovation, allows our products to be used in the most diverse **industrial applications**; alarm management is very important for safety and this is why all the controllers are designed to supply effective diagnostics whether at local level or by connection to remote assistance system. Dixell devices are particularly adaptable and make the application easy to use even in the **industrial automation** field, thanks to the wide range of products available and their compatibility with current safety standards.



## INFO

For **further information** about all Dixell products please check out our Web Site **[www.dixell.com](http://www.dixell.com)**.





## RANGE



### PARAMETRIC CONTROLLERS

Different needs that crowd the refrigeration world are satisfied with a complete series of parametric controllers with an innovative design and intuitive interfaces. Intelligent algorithms, most of those are oriented toward the **energy saving**, and **innovative functions** mark a range of products that includes different fields of cooling world giving a wide range of general purpose solution, for multiplexed cabinets, cabinets and rooms, bottle cooler, blast chiller, compressor racks and refrigerated trucks. Specific solutions that are used also in applications such as pharmaceutical or fan speed, food warming cabinets and ovens control and in temperature, humidity and pressure regulation.



### PROGRAMMABLE CONTROLLERS

The iPro family of controllers, whether dedicated for HVAC/R units or for general purposes, is characterized by the most advanced technology in **connectivity** and processing speed.

iPro controllers are based on a powerful platform that includes one hardware configuration that is able to expand the actual solution in the market, and software that, thanks to the ISaGRAF® development environment, allows the development through standard programming languages.

An **easy** and **useful HMI** is also guaranteed through graphic displays and the touch screen, as the **expandability** and the solution to many applications are satisfied with a complete range of accessories, including I/O expansion modules, proportional electronic valve management, modem, wirings, and more.







## SYSTEMS

The XWEB System family is based on web technology used to satisfy monitoring and supervising requirements in Commercial and Industrial Refrigeration fields from small shops to hypermarkets, and refrigerated warehouses to food production centers. Other potential fields are: chemical-pharmaceutical, oenological, naval, museums, hospital, etc. Dixell Systems conform to **HACCP** rules; the **CRO** (compressor rack optimization) reduced Set-point, anti-sweet heaters, lights and the power peaks are used with the result of having an optimize **energy savings**. It is also important to have the possibility to have integration with air conditioning machines that are equipped with iCHILL and iPro Dixell controllers. For retrofitting we offer ICOOLL **wireless** (RF) modules plus relay and acquisition module families for probe inputs and alarm outputs. All XWEB's can be connected anywhere with XCENTER, the program for the centralized management for a modern and organized **Call Center**, dedicated to alarm management and for a pro-active Service based on the Oracle database.



## PROBES and ACCESSORIES

A complete series of probes & transducers for temperature, humidity, and pressure ensures that for every application the end user has the right level of accuracy and the appropriate lead time.

A family of useful accessories such as modems, wirings, serial interfaces, programming kits, and protections makes it easy, fast, and accurate to use each instrument in every situation, especially with a remote connection or for energy analysis.

## CORPORATE and HOMOLOGATIONS

All the production conforms to **CE** norms with regards to low voltage and electromagnetic compatibility. For many models, Dixell has the voluntary mark at approval Authority (**ENEC, usULc**) ensuring a reliable international rules conformance.



### CE mark

It indicates conformity to the European Directives issued to guarantee the safety of the users and the environment. It is obligatory for all products distributed within the European Community. It does not replace the voluntary Quality Mark.



### ENEC mark

Voluntary quality mark recognised as equivalent to the single national marks of the Countries adherent to the accord. It certifies that a product conforms to the European norms EN, and that it has been manufactured by a company with quality systems conforming to ISO 9000 norms.



### UL mark

Voluntary quality mark, valid for the American Market. It certifies conformity of a product to the American safety directives, which sometimes differ from European ones.



### GOST-R

Voluntary certificate valid for the Russian Market. It certifies quality of supplied goods and their conformity with norms and standards Russian Federation.



# GENERAL PURPOSE REFRIGERATION CONTROLLERS

## SECTION INDEX

FUNCTIONS	MODELS	
<b>THERMOMETER – temperature display</b>		<b>12</b>
LED thermometers	XT11S – XT11CX – XA100C	13
<b>PRIME CX – NT and LT applications</b>		<b>14</b>
Thermostat and "off cycle" defrost controller	XR10CX – XR20CX	16
Controllers for static applications	XR30CX – XR35CX XR40CX – XR50CX	16
Controllers for ventilated applications	XR60CX – XR64CX XR70CX – XR71CX – XR72CX XR75CX – XR77CX	17
Controller for milk cooling and for air dryers	XR80CX	19
<b>PRIME D – NT and LT applications</b>		<b>20</b>
Thermostat and "off cycle" defrost controller	XR10D – XR20D	21
Controllers for static applications	XR30D	21
Controllers for ventilated applications	XR60D – XR70D	21
Controller for milk cooling	XR80D	21
<b>UNIVERSAL-R – heating applications, NT and LT – 7 pre-configured maps</b>		<b>22</b>
Universal controller for service replacement	UNIV-R4	23
<b>WING – NT and LT applications – compact/split format</b>		<b>26</b>
Innovative aesthetical solutions		24
Controllers for static applications	XW20L – XW20LT – XW20LR XW20LRT – XW20V – XW20VS XW20K – XW40L – XW40K	29
Controllers for ventilated applications	XW60L – XW60LT – XW60LR XW60LRT – XW60V – XW60VS XW60K – XW70L – XW70LT XW70K – XW90L – XW90LT	31
Keyboards for controllers in K format	CX620 – TX620 – T620T – VX620 TX820 – T820T – VX820	34



## THERMOMETER: TEMPERATURE DISPLAY

- Measurement unit integrated on the display
- Hot Key or Prog Tool Kit connector for quick and easy programming (XA100C and XT11CX)
- 3VA max power absorption
- Display with red LED 11,5mm high (S format) or 13,2mm high (C and CX formats)
- Temperature alarm (XT11CX)

### HOW to ORDER

**XT11S**    X T 1 1 S - A B C O N    For blue display please contact Dixell

A	B	C
<b>Power supply</b>	<b>Digits n°-measurement unit</b>	<b>Display update delay</b>
0 = 12Vac/dc 1 = 24Vac/dc 4 = 110Vac 5 = 230Vac	0 = °C - integer 1 = °F - integer 2 = °C - decimal point	0 = No delay 1 = 1 min 2 = 3 min

**XT11CX**    X T 1 1 C X - A B C D O    For blue display please contact Dixell

A	B	C	D
<b>Power supply</b>	<b>Inputs</b>	<b>Display update delay</b>	<b>Measurement unit</b>
4 = 110Vac 5 = 230Vac	P = PTC N = NTC	0 = No delay 1 = 1 min 2 = 3 min	C = °C F = °F

**XA100C**    X A 1 0 0 C - A B O D U    For blue display please contact Dixell

A	B	D
<b>Power supply</b>	<b>Measurement unit</b>	<b>Input</b>
0 = 12Vac/dc 1 = 24Vac/dc 4 = 110Vac 5 = 230Vac	C = °C F = °F B = Bar P = PSI H = %RH N = No measurement unit	P = PTC (NTC) T = PTC (NTC, Pt100, TcJ, TcK, TcS) A = 4÷20mA, 0÷1V, 0÷10V B = PP07 (-0.5÷7bar) C = PP30 (0÷30bar) D = PP11 (-0.5÷11bar) H = XH 10/20P

**XT11S**  
**XT11CX** | Digital thermometers with max and min log, powered directly by main voltage

**XA100C** | Configurable digital indicator



CX: 32x74mm



S: 31x64mm



C: 32x74mm

FEATURES	XT11S	XT11CX	XA100C
Display: n° digits	± 3 d.p.	± 3 d.p.	± 3 d.p.
Power supply	12, 24Vac/dc 110, 230Vac	110, 230Vac	12, 24Vac/dc 110, 230Vac
Measurement range	-40÷ 50°C -40÷ 122°F	probe dependent	probe dependent
Inputs			
Probe	NTC included	NTC, PTC	NTC, PTC, Pt100 TcJ, TcK, TcS 4÷ 20mA, 0÷ 1V, 0÷ 10V
Other			
Temperature alarm		pres	pres
Hot Key/Prog Tool Kit output		pres	pres
Digital input			TTL
Serial output			opt
Buzzer			via keyboard
Offset adjustment	back side trimmer	via keyboard	

## XT11S

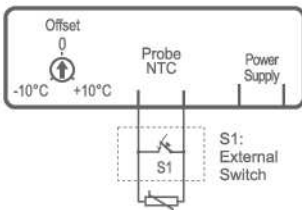

## XT11CX

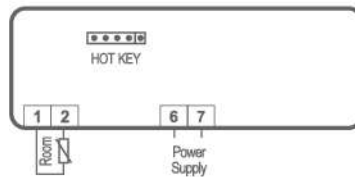

## XA100C

- \* 4÷20mA, 0+1V, 0+10V= 9(In); 11(gnd); 10(+)
- \* Pt100= 9 - 11(10) \* NTC, PTC= 9(In); 10(gnd)
- \* TcK, TcJ, TcS= 9(+)- 11(-)

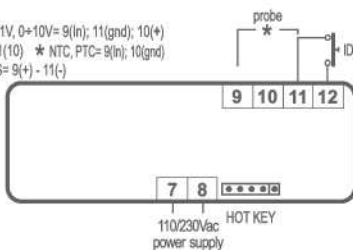

- \* 4÷20mA, 0+1V, 0+10V= 7(In); 9(gnd); 8(+)
- \* Pt100= 7 - 9(8) \* NTC, PTC= 7(In); 8(gnd)
- \* TcK, TcJ, TcS= 7(+)- 9(-)

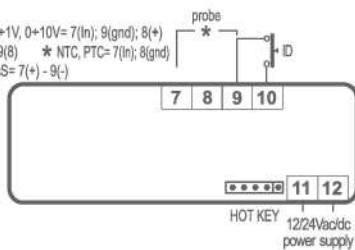



CX: 32x74mm

*Prime*



IP65

## PRIME CX SERIES: NT and LT APPLICATIONS

- Innovative digital controllers dedicated to heat and NT and LT refrigeration
- Easy and intuitive programming mode
- On/off key
- Energy saving cycles through digital input
- Fast freezing with dedicated set point
- Outputs restart with door open alarm
- Temperature Max and Min functions
- Configurable digital input also as probe
- Virtual probe management
- Cycles for milk cooling and storage systems
- Functions for refrigerated air dryers in automation processes
- Condenser temperature management to prevent critical plant situations
- Hot Key or Prog Tool Kit connector for quick and easy programming
- Serial connection to monitoring systems (direct for XR35/75/77CX or via XJ485CX)
- Connection for X-REP remote display (alternative to TTL output)
- 3VA max power absorption
- Display with red LED (10,5mm high) and icons



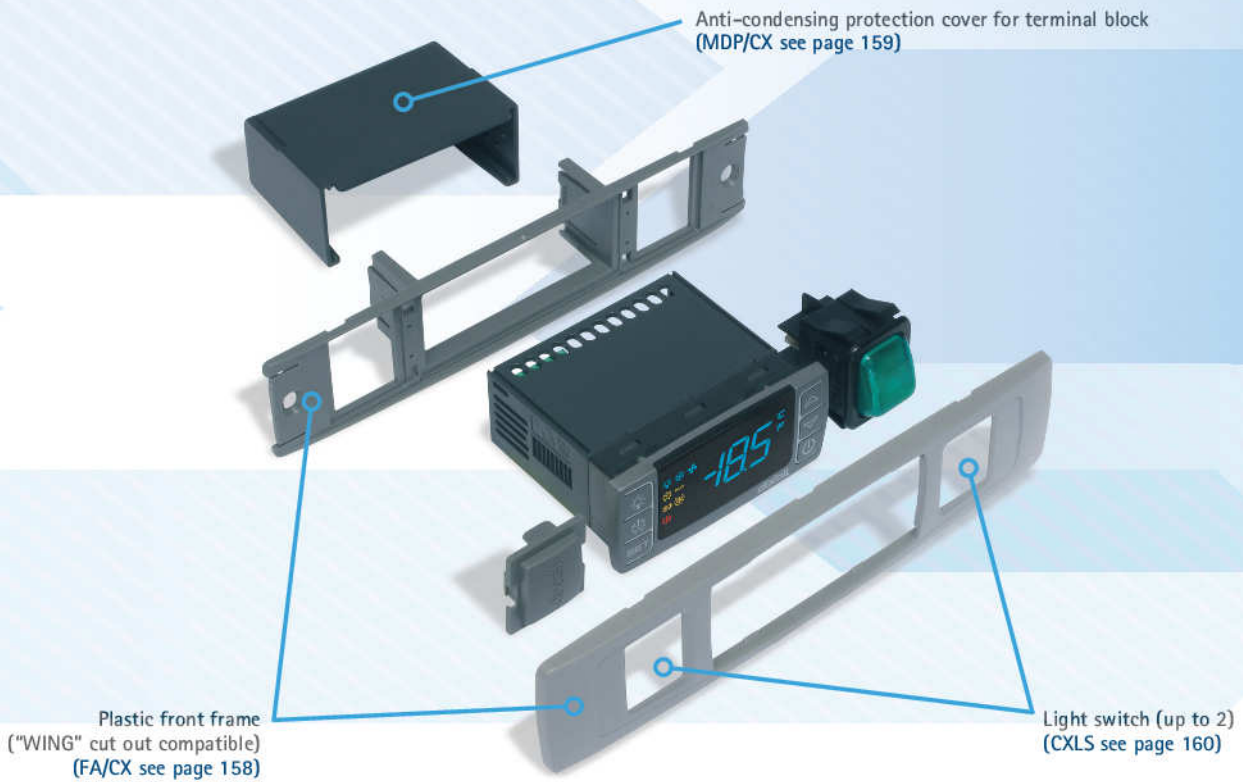

## HOW to ORDER

### PRIME CX

X R C X - A B C D E

**-17.8**

For blue display please contact Dixell

A	B	C	D	E			
<b>Power supply</b>	<b>Inputs</b>	<b>Buzzer</b>	<b>X-REP output</b> (excludes TTL output)	<b>Measurement unit</b>	<b>RTC</b>	<b>Compressor output</b>	<b>Connections</b>
0 = 12Vac/dc 1 = 24Vac/dc 2 = 24Vac 4 = 110Vac 5 = 230Vac	N = NTC P = PTC	0 = No 1 = Yes 2 = No 3 = Yes	No No Yes Yes	C = °C F = °F H = °C heating (only for XR10CX) L = °F heating (only for XR10CX) I* = °C M* = °F * Only for XR30/70CX	No No No Yes supercap Yes supercap	0 = 8A 1 = 20A 3 = 16A 6 = 8A 7 = 20A 8 = 16A	Screw Screw Screw Faston Faston Faston

### XR35/75/77CX

X R C X - A B C D E

**-17.8**

For blue display please contact Dixell

A	B	C	D	E	
<b>Power supply</b>	<b>Inputs</b>	<b>Buzzer</b>	<b>Measurement unit</b>	<b>RTC</b>	<b>Compressor output</b>
0 = 12Vac/dc (only for XR77CX) 1 = 24Vac/dc (only for XR77CX) 4 = 110Vac 5 = 230Vac	N = NTC S = Pt1000	6 = No 7 = Yes	C = °C F = °F I = °C M = °F	No No Yes supercap Yes supercap	0 = 8A 3 = 16A

### XR80CX

X R 8 0 C X - A B C D E

**-17.8**

For blue display please contact Dixell

A	B	C	D	E
<b>Power supply</b>	<b>Inputs</b>	<b>Buzzer</b>	<b>Measurement unit</b>	<b>Compressor output</b>
0 = 12Vac/dc 4 = 110Vac 5 = 230Vac	N = NTC P = PTC	0 = No 1 = Yes	C = °C F = °F	0 = 8A 3 = 20A



CX: 32x74mm

<b>XR10CX</b>	Digital thermostat with heating or cooling action
<b>XR20CX</b>	Digital controller for NT with "off cycle" defrost
<b>XR30CX</b>	Digital controller for NT with "off cycle" defrost and additional configurable relay
<b>XR35CX</b>	Digital controller for NT with "off cycle" defrost, additional configurable relay and RS485
<b>XR40CX</b>	Digital controller for NT and LT with electrical or hot gas defrost

FEATURES	XR10CX	XR20CX	XR30CX	XR35CX	XR40CX
<b>Display: n° digits</b>	± 3 d.p.	± 3 d.p.	± 3 d.p.	± 3 d.p.	± 3 d.p.
<b>Power supply</b>	12, 24Vac/dc 24, 110, 230Vac	12, 24Vac/dc 24, 110, 230Vac	12, 24Vac/dc 24, 110, 230Vac	110, 230Vac	12, 24Vac/dc 24, 110, 230Vac
<b>Probe inputs</b>					
Thermostat	NTC, PTC	NTC, PTC	NTC, PTC	NTC, Pt1000	NTC, PTC
Thermostat 2					
Defrost				NTC, Pt1000	NTC, PTC
Defrost 2					
Condenser	NTC, PTC on HOT KEY	NTC, PTC on HOT KEY	NTC, PTC on HOT KEY	NTC, Pt1000	NTC, PTC on HOT KEY
<b>Digital inputs</b>					
Alarm, start defrost, AUX, door switch, pressure switch, probe	config	config	config	config	config
Alarm, start defrost, AUX, door switch, pressure switch				config	
<b>Relay outputs</b>					
Compressor	8A, 20A	8A, 20A	8A, 20A	8A, 16A	8A, 20A
Compressor 2					
Thermostat 2					
Defrost					8A
Defrost 2					
Fans					
Light or alarm			8A	8A	
Anti-sweat					
Agitator					
<b>Other</b>					
Hot Key/Prog Tool Kit output	pres	pres	pres	pres	pres
Remote display output	X-REP opt	X-REP opt	X-REP opt	X-REP	X-REP opt
Serial output	TTL	TTL	TTL	RS485	TTL
Buzzer	opt	opt	opt	opt	opt
Real time clock			opt	opt	

XR10CX - XR20CX

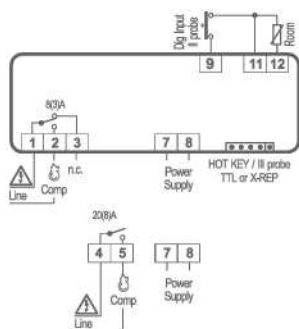

XR30CX

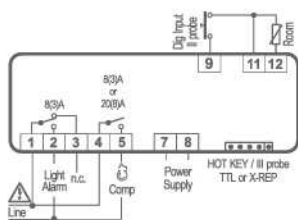

XR35CX

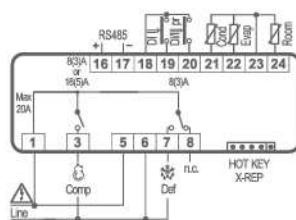

XR40CX

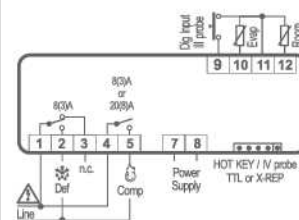



# CONTROLLERS for STATIC or VENTILATED APPLICATIONS

# PRIME CX

- XR50CX** | Digital controller for NT and LT static applications with electrical or hot gas defrost and auxiliary relay
- XR60CX** | Digital controller for NT and LT ventilated applications with dual humidity function
- XR64CX** | Digital controller for NT and LT ventilated applications with dual evaporators



CX: 32x74mm

FEATURES	XR50CX		XR60CX		XR64CX	
<b>Display: n° digits</b>	± 3 d.p.	± 3 d.p.	± 3 d.p.	± 3 d.p.	± 3 d.p.	± 3 d.p.
<b>Power supply</b>	12, 24Vac/dc 24, 110, 230Vac	110, 230Vac	12, 24Vac/dc 24, 110, 230Vac	110, 230Vac	110, 230Vac	12Vac/dc
<b>Probe inputs</b>						
Thermostat	NTC, PTC	NTC, PTC	NTC, PTC	NTC, PTC	NTC, PTC	NTC, PTC
Thermostat 2						
Defrost	NTC, PTC	NTC, PTC	NTC, PTC	NTC, PTC	NTC, PTC	NTC, PTC
Defrost 2					NTC, PTC	NTC, PTC
Condenser	NTC, PTC on HOT KEY	NTC, PTC on HOT KEY	NTC, PTC on HOT KEY	NTC, PTC on HOT KEY	NTC, PTC on HOT KEY	NTC, PTC on HOT KEY
<b>Digital inputs</b>						
Alarm, start defrost, AUX, door switch, pressure switch, probe	config	config	config	config	config	config
Alarm, start defrost, AUX, door switch, pressure switch						
<b>Relay outputs</b>						
Compressor	8A, 16A	20A	8A, 16A	20A	8A, 16A	16A
Compressor 2						
Thermostat 2						
Defrost	8A	8A	8A	8A	8A	16A
Defrost 2					8A	16A
Fans			8A	5A	5A	16A
Light or alarm	8A	5A				
Anti-sweat						
Agitator						
<b>Other</b>						
Hot Key/Prog Tool Kit output	pres	pres	pres	pres	pres	pres
Remote display output	X-REP opt	X-REP opt	X-REP opt	X-REP opt	X-REP opt	X-REP opt
Serial output	TTL	TTL	TTL	TTL	TTL	TTL
Buzzer	opt	opt	opt	opt	opt	opt
Real time clock						

## XR50CX

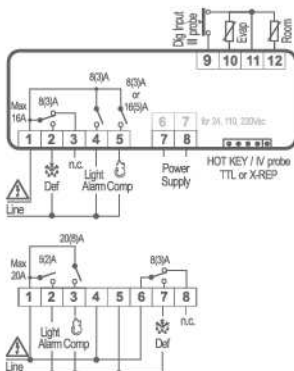

## XR60CX

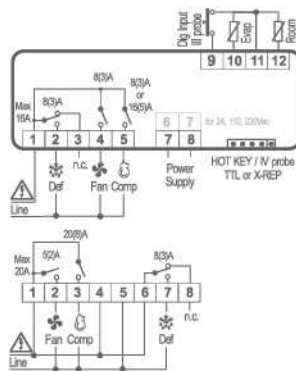

## XR64CX

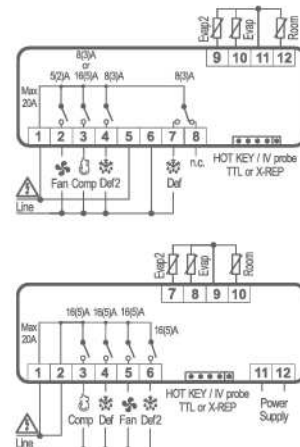



CX: 32x74mm

**XR70CX** | Digital controller for NT and LT with auxiliary relay and dual humidity function

**XR71CX** | Digital controller for NT and LT with anti sweat heater management

**XR72CX** | Digital controller for NT and LT with dual compressor management

FEATURES	XR70CX		XR71CX		XR72CX	
<b>Display: n° digits</b>	± 3 d.p.	± 3 d.p.	± 3 d.p.	± 3 d.p.	± 3 d.p.	± 3 d.p.
<b>Power supply</b>	110, 230Vac	12Vac/dc	110, 230Vac	12Vac/dc	110, 230Vac	12Vac/dc
<b>Probe inputs</b>						
Thermostat	NTC, PTC	NTC, PTC	NTC, PTC	NTC, PTC	NTC, PTC	NTC, PTC
Thermostat 2						
Defrost	NTC, PTC	NTC, PTC	NTC, PTC	NTC, PTC	NTC, PTC	NTC, PTC
Defrost 2						
Condenser	NTC, PTC on HOT KEY	NTC, PTC on HOT KEY	NTC, PTC on HOT KEY	NTC, PTC on HOT KEY	NTC, PTC on HOT KEY	NTC, PTC on HOT KEY
<b>Digital inputs</b>						
Alarm, start defrost, AUX, door switch, pressure switch, probe	config	config	config	config	config	config
Alarm, start defrost, AUX, door switch, pressure switch						
<b>Relay outputs</b>						
Compressor	8A, 16A	16A	8A, 16A	16A	8A, 16A	16A
Compressor 2					8A	16A
Thermostat 2						
Defrost	8A	16A	8A	16A	8A	16A
Defrost 2						
Fans	5A	16A	5A	16A	5A	16A
Light or alarm	8A	16A				
Anti-sweat			8A	16A		
Agitator						
<b>Other</b>						
Hot Key/Prog Tool Kit output	pres	pres	pres	pres	pres	pres
Remote display output	X-REP opt	X-REP opt	X-REP opt	X-REP opt	X-REP opt	X-REP opt
Serial output	TTL	TTL	TTL	TTL	TTL	TTL
Buzzer	opt	opt	opt	opt	opt	opt
Real time clock	opt	opt	opt	opt	opt	opt

### XR70CX

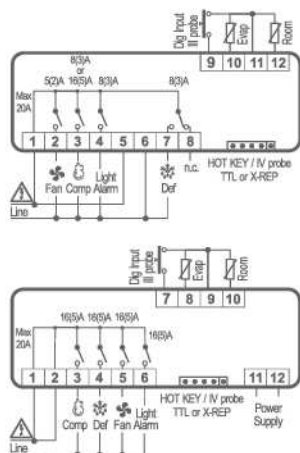

### XR71CX

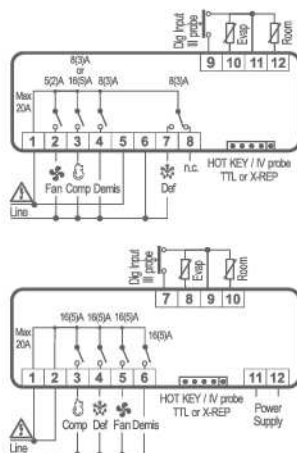

### XR72CX

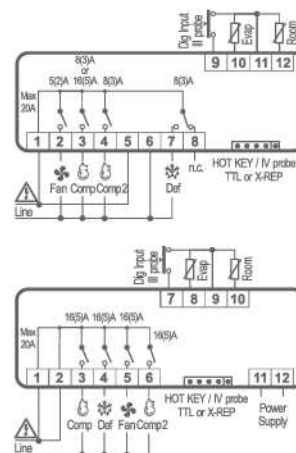

# CONTROLLERS for VENTILATED APPLICATIONS or for MILK COOLING and AIR DRYERS

# PRIME CX

<b>XR75CX</b>	Digital controller for NT and LT ventilated applications with auxiliary relay, dual humidity function and RS485
<b>XR77CX</b>	Digital controller for NT and LT ventilated applications with auxiliary relay, dual humidity function, RS485 and relay with separated common lines
<b>XR80CX</b>	Digital controller for storage, milk cooling, and for refrigerated air dryers



CX: 32x74mm

FEATURES	XR75CX	XR77CX	XR80CX
<b>Display: n° digits</b>	± 3 d.p.	± 3 d.p.	± 3 d.p.
<b>Power supply</b>	110, 230Vac	12, 24Vac/dc 110, 230Vac	12Vac/dc 110, 230Vac
<b>Probe inputs</b>			
Thermostat	NTC, Pt1000	NTC/Pt1000	NTC, PTC
Thermostat 2			
Defrost	NTC, Pt1000	NTC, Pt1000	
Defrost 2			
Condenser	NTC, Pt1000	NTC, Pt1000	
<b>Digital inputs</b>			
Alarm, start defrost, AUX, door switch, pressure switch, probe	config	config	
Alarm, start defrost, AUX, door switch, pressure switch	config	config	config
<b>Relay outputs</b>			
Compressor	8A, 16A	8A, 12A	8A, 20A
Compressor 2			
Thermostat 2			
Defrost	8A	12A	
Defrost 2			
Fans	5A	5A	
Light or alarm	8A	7A	
Anti-sweat			
Agitator			8A
<b>Other</b>			
Hot Key/Prog Tool Kit output	pres	pres	pres
Remote display output	X-REP	X-REP	
Serial output	RS485	RS485	TTL
Buzzer	opt	opt	opt
Real time clock	opt	opt	

## XR75CX

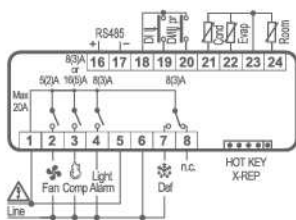

## XR77CX

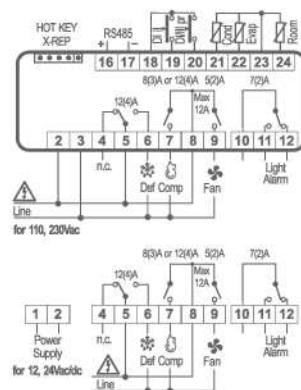

## XR80CX

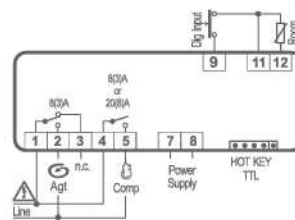



D: 4 DIN Rail

## PRIME D SERIES: NT and LT APPLICATIONS

- Innovative digital controllers dedicated to normal and low temperature refrigerated applications
- Direct line power supply 230 (110)Vac. No external transformer required
- Direct driving of compressors up to 1,2HP, (20A relay inside)
- Pre-programming of the main control variables, easy and intuitive programming mode
- Keyboard lock, alarm signalling by relay, display or buzzer
- Configurable digital input for door switch, defrost, general or serious alarm
- Auxiliary relay activated through keys or digital input
- Hot Key connector for quick and easy programming
- HACCP function
- 3VA max power absorption
- Display with red LED (13,2mm high)

### HOW to ORDER

PRIME D    X R    D - A B C D E     For blue display please contact Dixell

A	B	C	D	E
<b>Power supply</b>	<b>Inputs</b>	<b>Buzzer</b>	<b>Measurement unit</b>	<b>Compressor output</b>
2 = 24Vac 4 = 110Vac 5 = 230Vac	P = PTC N = NTC	0 = No 1 = Yes	C = °C F = °F H = °C heating only for XR10D L = °F heating only for XR10D	0 = 8A 1 = 20A

# THERMOSTAT and CONTROLLERS for STATIC or VENTILATED APPLICATIONS or for MILK COOLING

# PRIME D

<b>XR10D</b>	Digital thermostat with heating or cooling action
<b>XR20D</b>	Digital controller for NT with "off cycle" defrost
<b>XR30D</b>	Digital controller for NT with "off cycle" defrost and additional configurable relay
<b>XR60D</b>	Digital controller for NT and LT ventilated applications with door switch capability
<b>XR70D</b>	Digital controller for NT and LT ventilated applications with door switch capability and auxiliary relay
<b>XR80D</b>	Digital controller for milk cooling with agitation cycle capability



D: 4 DIN Rail

FEATURES	XR10D	XR20D	XR30D	XR60D	XR70D	XR80D
<b>Display: n° digits</b>	± 3 d.p.	± 3 d.p.	± 3 d.p.	± 3 d.p.	± 3 d.p.	± 3 d.p.
<b>Power supply</b>	24, 110, 230Vac	24, 110, 230Vac	24, 110, 230Vac	24, 110, 230Vac	24, 110, 230Vac	24, 110, 230Vac
<b>Probe inputs</b>						
Thermostat	NTC, PTC	NTC, PTC	NTC, PTC	NTC, PTC	NTC, PTC	NTC, PTC
Defrost				NTC, PTC	NTC, PTC	
<b>Digital inputs</b>						
Alarm, start defrost, AUX, door switch, pressure switch	config	config	config	config	config	
<b>Relay outputs</b>						
Compressor	no 8A/nc 5A, 20A	no 8A/nc 5A, 20A	no 8A/nc 5A, 20A	no 8A/nc 5A, 20A	no 8A/nc 5A, 20A	no 8A/nc 5A, 20A
Defrost				no 8A/nc 5A	no 8A/nc 5A	
Fans				8A	8A	
Alarm					no 8A/nc 5A	
Agitator						no 8A/nc 5A
Alarm or auxiliary			no 8A/nc 5A			
<b>Other</b>						
Functions	HACCP	HACCP	HACCP	HACCP	HACCP	min/max
Hot Key output	pres	pres	pres	pres	pres	pres
Buzzer	opt	opt	opt	opt	opt	opt

## XR10D - XR20D

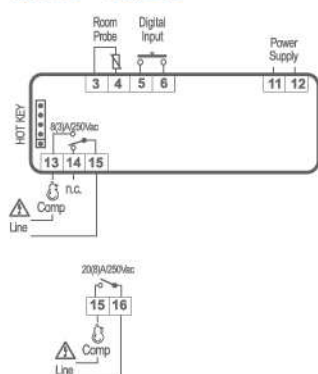

## XR30D

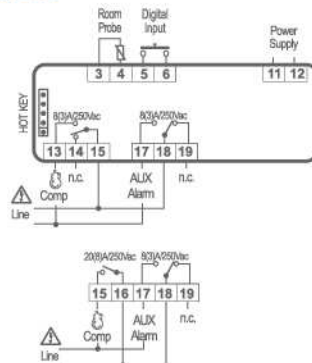

## XR60D

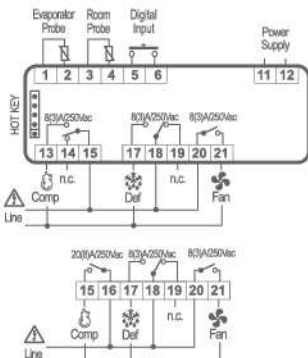

## XR70D

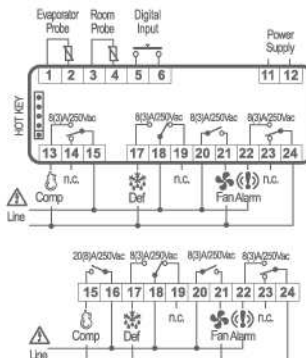

## XR80D

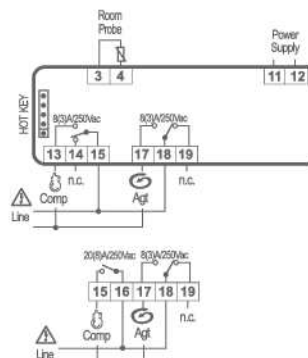



## UNIVERSAL-R: HEATING APPLICATIONS, NT and LT 7 PRE-CONFIGURED MAPS

- Designed to replace over 150 models of refrigeration/heating controllers in 32x74mm format
- Easy and quick installation
- Rapid set-up in 3 simple steps
- Dual voltage power supply 12Vac/dc and 230Vac
- Specific functions to control twin evaporator defrost
- Automatic probe detection
- Complete condenser management
- Hot Key or Prog Tool Kit connector for quick and easy programming
- 3VA max power absorption
- Display with red LED (10,5 mm high) and icons
- 7 pre-configured applications selectable from parameter **EC**

**EC1** = on/off thermostat - cooling

**EC2** = thermostat with off cycle defrost

**EC3** = thermostat with electric/hot gas defrost, time initiated and time terminated

**EC4** = thermostat with electric/hot gas defrost, time initiated and temperature terminated

**EC5** = thermostat with electric/hot gas defrost, time initiated and temperature terminated and evaporator fan

**EC6** = twin evaporator defrost applications

**EC7** = on/off thermostat - heating

### HOW to ORDER

UNIVERSAL-R    U N I V - R 4 - 6 B 1 D 0

B	D
Inputs	Measurement unit
P = PTC	C = °C
N = NTC	F = °F

# UNIVERSAL CONTROLLER for SERVICE REPLACEMENT

# UNIVERSAL-R

## UNIV-R4

Controller for service replacement of refrigeration and heating controllers with 7 pre-configured maps



CX: 32x74mm

FEATURES	UNIV-R4 (tC=1)	UNIV-R4 (tC=2)	UNIV-R4 (tC=3)	UNIV-R4 (tC=4)	UNIV-R4 (tC=5)	UNIV-R4 (tC=6)	UNIV-R4 (tC=7)
Display: n° digits	± 3 d.p.	± 3 d.p.	± 3 d.p.	± 3 d.p.	± 3 d.p.	± 3 d.p.	± 3 d.p.
Power supply	12Vac/dc 230Vac	12Vac/dc 230Vac	12Vac/dc 230Vac	12Vac/dc 230Vac	12Vac/dc 230Vac	12Vac/dc 230Vac	12Vac/dc 230Vac
<b>Probe inputs</b>							
Thermostat	NTC, PTC	NTC, PTC	NTC, PTC	NTC, PTC	NTC, PTC	NTC, PTC	NTC, PTC
Defrost				NTC, PTC	NTC, PTC	NTC, PTC	
Defrost 2						NTC, PTC	
<b>Digital inputs</b>							
Alarm, defrost, AUX, door switch, pressure switch, ON/OFF, energy saving	2 x config	2 x config	2 x config	2 x config	2 x config	1 x config	2 x config
<b>Relay outputs</b>							
Compressor	8A	8A	8A	8A	8A	8A	
Defrost			8A	8A	8A	8A	
Defrost 2						8A	
Fans					8A	8A	
Light or alarm	8A	8A	8A	8A	8A		8A
Heating							8A
<b>Other</b>							
Hot Key/Prog Tool Kit output	pres	pres	pres	pres	pres	pres	pres
Buzzer	pres	pres	pres	pres	pres	pres	pres

### UNIV-R4 (tC 1-2)

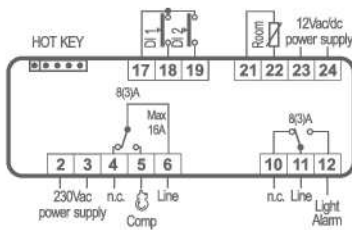

### UNIV-R4 (tC 3)

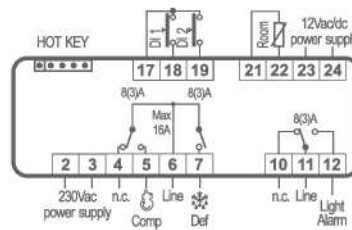

### UNIV-R4 (tC 4)

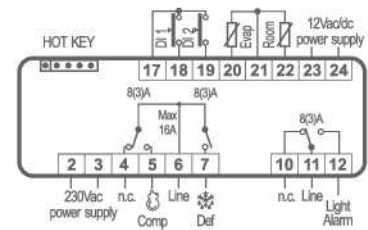

### UNIV-R4 (tC 5)

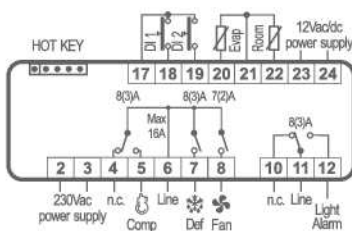

### UNIV-R4 (tC 6)

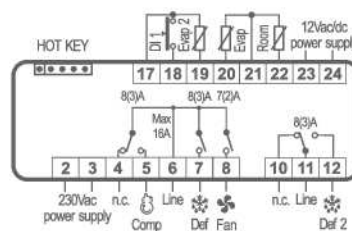

### UNIV-R4 (tC 7)

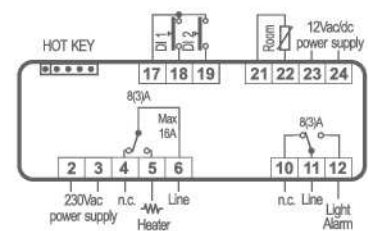

# WING: INNOVATIVE AESTHETICAL SOLUTIONS

The WING family, characterized by a high aesthetical value, presents a series of solutions able to satisfy every need in refrigeration field especially when the design becomes a fundamental, such as for cream freezers or pastry refrigerators etc... This series is available in classic formats, Compact (L and V) and Split (K), with vertical or horizontal keyboard. In particular, horizontal format is divided in 2 macro families:

- **WING TOUCH**;
- **WING STANDARD** (available also INOX or BACK-PANEL with POLYCARBONATE).

Great versatility and customization are given to these models thanks to the reduced space (LR) and to the display with icons that, depending on the model, can be white, red or blue.

## WING TOUCH

- Capacitive TOUCH technology
- Frontal backlit
- Standard or back-panel front mounting



IP65



Back-panel mounting with PM-WLT bracket (surface thickness 0.8÷1.0mm)



Standard front mounting

## MOUNTING OPTIONS

Depending on the model, Dixell gives different mounting solutions. High protection, great aesthetic value, easy and quick fixing mode are guaranteed by the solutions below:

STANDARD mounting with screws

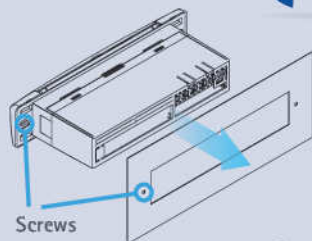

Screws

BACK-PANEL mounting with captive screws (PG-L bracket optional)

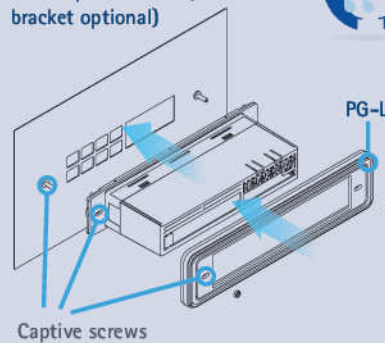

Captive screws

PG-L

BACK-PANEL mounting with PM-WL(T) dedicated bracket

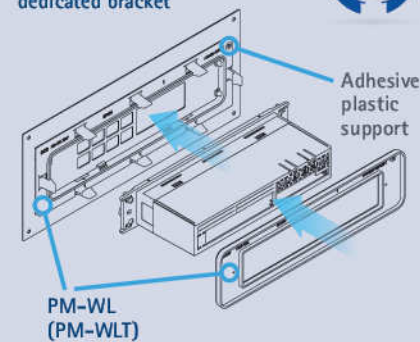

Adhesive plastic support

PM-WL (PM-WLT)

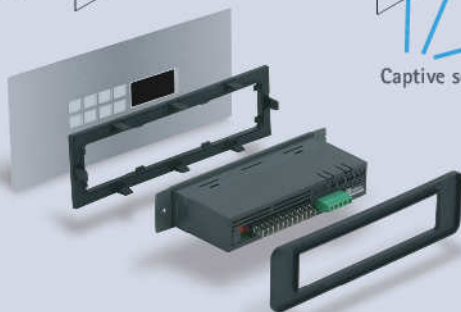

The PM-WL (PM-WLT for WING TOUCH) bracket, developed by Dixell, is the ideal solution for back-panel mounting without using captive screws. The fixing system is composed of 2 parts: one adhesive to be put on the panel, and one movable to hold the instrument.



## WING STANDARD



- Frontal glass frame to protect the keys
- Standard front mounting



IP65



### WING INOX option

IP65



- Bright or satinized steel front
- Standard or back-panel front mounting



Standard front mounting



Back-panel mounting with captive screws (+ PG-L protection) or using the PM-WL bracket (surface thickness 0.8÷1.0mm)

### BACK-PANEL with POLYCARBONATE option

- Front polycarbonate that can be easily customized
- Back-panel mounting

IP65



Back-panel mounting with captive screws (+ PG-L protection) or using the PM-WL bracket (surface thickness 0.8÷1.0mm)

	Formats	Front mounting	Back-panel mounting with captive screws	Back-panel mounting with bracket
WING TOUCH	LT, LRT, TOUCH keyboards	yes	no	yes with PM-WLT bracket
WING STANDARD	L, LR, T keyboards	yes	no	no
INOX option	L, LR, T keyboards	yes	yes with PG-L bracket optional	yes with PM-WL bracket
POLYCARBONATE option	L, LR, T keyboards	no	yes with PG-L bracket optional	yes with PM-WL bracket



## WING SERIES: NT and LT APPLICATIONS – COMPACT/SPLIT FORMAT

- Innovative controllers with different aesthetic solutions that enhance the final product
- Direct live and neutral load connections for reduction of wiring costs
- Direct driving of compressors up to 1,2HP (20A relay inside)
- Direct line power supply. No external transformer required
- Up to 8 push buttons with direct action for user friendly interface
- Maximum and minimum temperature recording
- High and low humidity control simple or floating
- Smart defrost
- Integrated functions for energy saving
- Continuous cycle with a dedicated set point
- Virtual probe management
- Hot Key or Prog Tool Kit connector for quick and easy programming
- Connection for X-REP remote display
- Serial connection to monitoring systems
- 7VA max power absorption
- LED display (10,5mm high) and icons

LR and VS formats are the specific solution for all applications with a reduced space

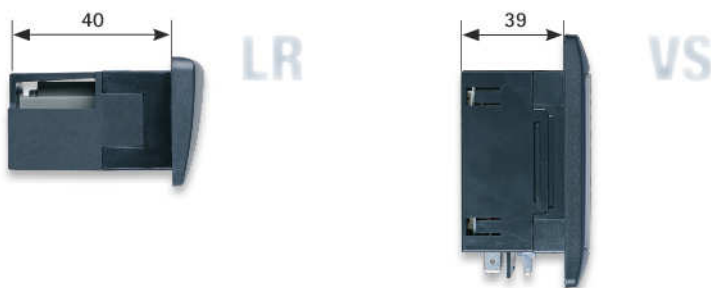

Controllers are provided with a wide display with integrated icons of the real time situation and the measurement unit, for clear and continuous monitoring.



### HOW to ORDER

WING L 

X	W		L	-	A	B	C	D	E	-	N
---	---	--	---	---	---	---	---	---	---	---	---

 For inox, blue display, back-panel with polycarbonate version please contact Dixell

A	B	C	D	E
<b>Power supply</b>	<b>Inputs</b>	<b>Light relay</b>	<b>Buzzer</b>	<b>RTC</b>
2 = 24Vac 4 = 110Vac 5 = 230Vac	N = NTC P = PTC L = NTC M = PTC O = NTC R = PTC	8A 8A 16A 16A 16A neon 16A neon	0 = No 1 = Yes 2 = No 3 = Yes	No No Yes supercap Yes supercap
				<b>Measurement unit</b>
				C = °C F = °F
				<b>X-REP</b>
				0 = No 1 = Yes

### WING LT

X	W		L	T	-	A	B	C	D	E
---	---	--	---	---	---	---	---	---	---	---

### WING LT back-panel mounting

X	W		L	T	-	A	B	C	D	E	-	R
---	---	--	---	---	---	---	---	---	---	---	---	---

A	B	C	D	E
<b>Power supply</b>	<b>Inputs</b>	<b>RTC</b>	<b>Measurement unit</b>	<b>Display</b>
2 = 24Vac 4 = 110Vac 5 = 230Vac	N = NTC P = PTC	1 = No 3 = Yes supercap	W = °C Y = °F C = °C F = °F D = °C G = °F	White White Red Red Blue Blue
				<b>X-REP</b>
				0 = No 1 = Yes

WING LR 

X	W		L	R	-	A	B	C	D	O	-	N
---	---	--	---	---	---	---	---	---	---	---	---	---

For inox, blue display, back-panel with polycarbonate version please contact Dixell

A	B	C	D
<b>Power supply</b>	<b>Inputs</b>	<b>Buzzer</b>	<b>RTC</b>
4 = 110Vac 5 = 230Vac	N = NTC P = PTC	0 = No 1 = Yes 2 = No 3 = Yes	No No Yes supercap Yes supercap
			<b>Measurement unit</b>
			C = °C F = °F

## HOW to ORDER

### WING LRT

X W L R T - A B C D O

### WING LRT back-panel mounting

X W L R T - A B C D O - R

A	B	C	D	
<b>Power supply</b>	<b>Inputs</b>	<b>RTC</b>	<b>Measurement unit</b>	
4 = 110Vac 5 = 230Vac	N = NTC P = PTC	1 = No 3 = Yes supercap	W = °C Y = °F C = °C F = °F D = °C G = °F	White White Red Red Blue Blue

### WING V

X W V - A B C D E

-17.8

For blue display please contact Dixell

### WING VS

X W V S - A B C D O

-17.8

For blue display please contact Dixell

A	B	C	D	E
<b>Power supply</b>	<b>Inputs</b>	<b>Buzzer</b>	<b>Measurement unit</b>	<b>Compressor output</b>
2 = 24Vac 4 = 110Vac 5 = 230Vac	N = NTC P = PTC	0 = No 1 = Yes	C = °C F = °F	0 = 8A 1 = 20A

### WING K

X W K - A B C D E

A	B	C	D	E
<b>Power supply</b>	<b>Inputs/light relay</b>	<b>Housing</b>	<b>Measurement unit</b>	<b>RTC</b>
2 = 24Vac 4 = 110Vac 5 = 230Vac	N = NTC P = PTC L = NTC/16A neon M = PTC/16A neon	0 = Open board "OS" 1 = Open board + 8 DIN Rail base 2 = 8 DIN Rail 3 = "GS" housing	C = °C F = °F	0 = No 2 = Yes supercap 4 = Battery

### CX/TX/VX KEYBOARDS

X 2 0 - A 0 0 N 0

inox

For inox and back-panel with polycarbonate version on TX keyboards please contact Dixell

-17.8

For blue display please contact Dixell

A

#### Buzzer

0 = No

1 = Yes

### TOUCH KEYBOARDS

T 2 0 T - 1 0 0 D 0

### TOUCH KEYBOARDS back-panel mounting

T 2 0 T - 1 0 0 D 0 - R

D

#### Display

N = Red

R = Blue

W = White

<b>XW20L</b>	Digital controller for NT with "off cycle" defrost
<b>XW20LT</b>	Digital controller for NT with "off cycle" defrost, TOUCH interface and red, white or blue display
<b>XW20LR</b>	Digital controller for NT with "off cycle" defrost and reduced depth
<b>XW20LRT</b>	Digital controller for NT with "off cycle" defrost, reduced depth, TOUCH interface and red, white or blue display



FEATURES	XW20L	XW20LT	XW20LR	XW20LRT
<b>Display: n° digits</b>	± 3 d.p.	± 3 d.p.	± 3 d.p.	± 3 d.p.
<b>Keyboard: push buttons</b>	6	6	6	6
<b>Power supply</b>	24, 110, 230Vac	24, 110, 230Vac	110, 230Vac	110, 230Vac
<b>Probe inputs</b>				
Thermostat	NTC, PTC	NTC, PTC	NTC, PTC	NTC, PTC
Defrost	NTC, PTC	NTC, PTC	NTC, PTC	NTC, PTC
Condenser	NTC, PTC	NTC, PTC	NTC, PTC	NTC, PTC
Display	NTC, PTC	NTC, PTC		
<b>Digital inputs</b>				
Alarm, start defrost, door switch, pressure switch, probe	config	config	config	config
DI 2	config	config	config	config
<b>Relay outputs</b>				
Compressor	20A	20A	20A	20A
Defrost				
Fans				
Light	8A, 16A	8A	8A	8A
Alarm, AUX				
RL 6 configurable				
<b>Other</b>				
Hot Key/Prog Tool Kit output	pres	pres	pres	pres
Remote display output	X-REP opt	X-REP opt		
Serial output	TTL	TTL	TTL	TTL
Triac output				
Buzzer	opt	pres	opt	pres
Real time clock	opt	opt	opt	opt

## XW20L

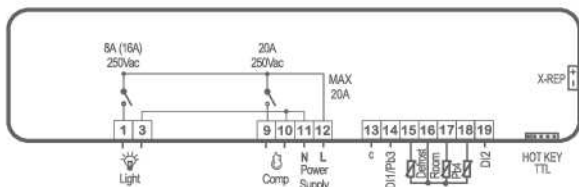

## XW20LT

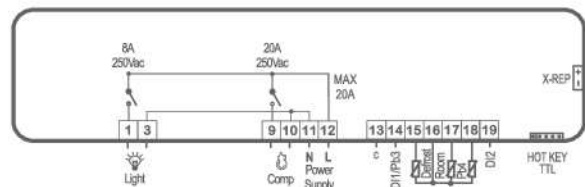

## XW20LR - XW20LRT

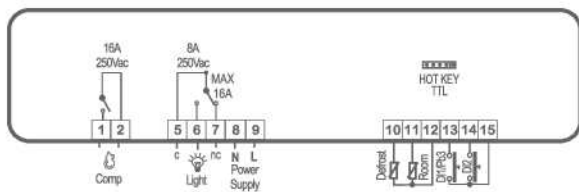



L: 38x185mm



V, VS: 100x64mm



K: OS/GS/8 DIN Rail

<b>XW20V</b>	Digital controller for NT with "off cycle" defrost
<b>XW20VS</b>	Digital controller for NT with "off cycle" defrost and reduced depth
<b>XW20K</b>	Digital controller in split format for NT with "off cycle" defrost
<b>XW40L</b>	Digital controller for NT and LT with electrical or hot gas defrost function
<b>XW40K</b>	Digital controller in split format for NT and LT with electrical or hot gas defrost function

FEATURES	XW20V	XW20VS	XW20K	XW40L	XW40K
<b>Display: n° digits</b>	± 3 d.p.	± 3 d.p.	on keyboard ± 3 d.p.	± 3 d.p.	on keyboard ± 3 d.p.
<b>Keyboard: push buttons</b>	6	6	6 (on CX620, TX620, T620T, VX620)		6 (on CX620, TX620, T620T, VX620)
<b>Power supply</b>	24, 110, 230Vac	24, 110, 230Vac	24, 110, 230Vac	24, 110, 230Vac	24, 110, 230Vac
<b>Probe inputs</b>					
Thermostat	NTC, PTC	NTC, PTC	NTC, PTC	NTC, PTC	NTC, PTC
Defrost				NTC, PTC	NTC, PTC
Condenser			NTC, PTC	NTC, PTC	NTC, PTC
Display		NTC, PTC	NTC, PTC	NTC, PTC	NTC, PTC
<b>Digital inputs</b>					
Alarm, start defrost, door switch, pressure switch, probe	config	config	config	config	config
DI 2				config	
<b>Relay outputs</b>					
Compressor	8A, 20A	16A	20A	20A	20A
Defrost				8A	16A
Fans					
Light	16A	16A	16A	8A, 16A	16A
Alarm, AUX					
RL 6 configurable					
<b>Other</b>					
Hot Key/Prog Tool Kit output	pres	pres	pres	pres	pres
Remote display output				X-REP opt	
Serial output			TTL	TTL	TTL
Triac output					
Buzzer	opt	opt	on keyboard	opt	on keyboard
Real time clock			opt	opt	opt

**XW20V**

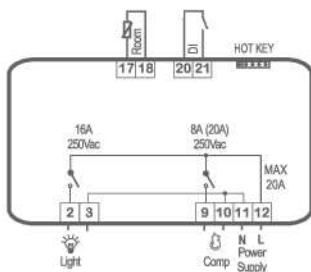

**XW20VS**

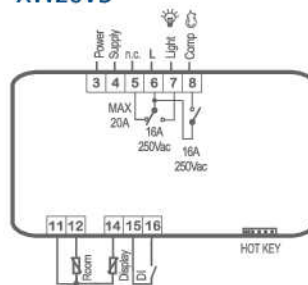

**XW20K**

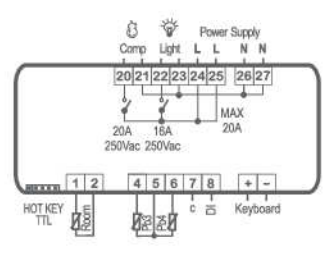

**XW40L**

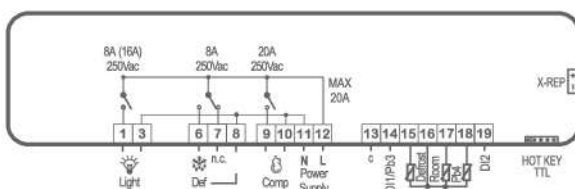

**XW40K**

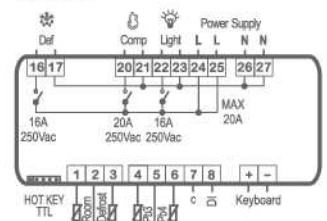

# CONTROLLERS for VENTILATED APPLICATIONS

# WING

<b>XW60L</b>	Digital controller for NT and LT with electrical or hot gas defrost function and fans
<b>XW60LT</b>	Digital controller for NT and LT with electrical or hot gas defrost function and fans, TOUCH interface and red, white or blue display
<b>XW60LR</b>	Digital controller for NT and LT with electrical or hot gas defrost function and fans and reduced depth
<b>XW60LRT</b>	Digital controller for NT and LT with electrical or hot gas defrost function and fans, reduced depth, TOUCH interface and red, white or blue display
<b>XW60V</b>	Digital controller for NT and LT with electrical or hot gas defrost function and fans
<b>XW60VS</b>	Digital controller for NT and LT with electrical or hot gas defrost function and fans and reduced depth



L, LR: 38x185mm



LT, LRT: 38x185mm V, VS: 100x64mm

FEATURES	XW60L	XW60LT	XW60LR	XW60LRT	XW60V	XW60VS
<b>Display: n° digits</b>	± 3 d.p.	± 3 d.p.	± 3 d.p.	± 3 d.p.	± 3 d.p.	± 3 d.p.
<b>Keyboard: push buttons</b>	6	6	6	6	6	5
<b>Power supply</b>	24, 110, 230Vac	24, 110, 230Vac	110, 230Vac	110, 230Vac	24, 110, 230Vac	24, 110, 230Vac
<b>Probe inputs</b>						
Thermostat	NTC, PTC	NTC, PTC	NTC, PTC	NTC, PTC	NTC, PTC	NTC, PTC
Defrost	NTC, PTC	NTC, PTC	NTC, PTC	NTC, PTC	NTC, PTC	NTC, PTC
Condenser	NTC, PTC	NTC, PTC	NTC, PTC	NTC, PTC		
Display	NTC, PTC	NTC, PTC				NTC, PTC
<b>Digital inputs</b>						
Alarm, start defrost, door switch, pressure switch, probe	config	config	config	config	config	config
DI 2	config	config	config	config		
<b>Relay outputs</b>						
Compressor	20A	20A	20A	20A	8A, 20A	16A
Defrost	8A	16A	8A	8A	8A	16A
Fans	8A	8A	5A	5A	8A	8A
Light	8A, 16A	8A			16A	
Alarm, AUX						
RL 6 configurable						
<b>Other</b>						
Hot Key/Prog Tool Kit output	pres	pres	pres	pres	pres	pres
Remote display output	X-REP opt	X-REP opt				
Serial output	TTL	TTL	TTL	TTL		
Triac output						
Buzzer	opt	pres	opt	pres	opt	opt
Real time clock	opt	opt	opt	opt		

## XW60L

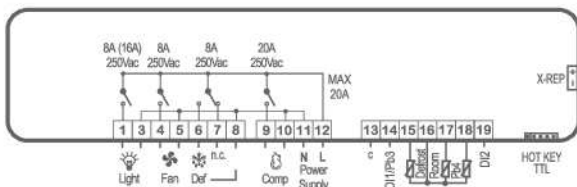

## XW60LT

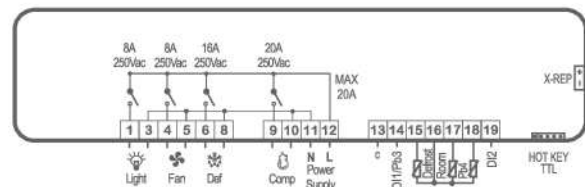

## XW60LR - XW60LRT

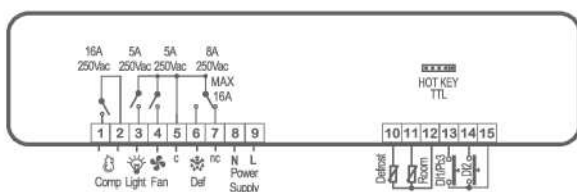

## XW60V

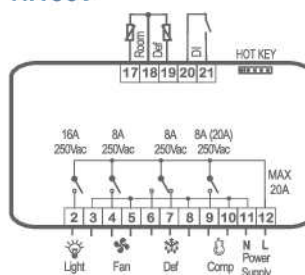

## XW60VS

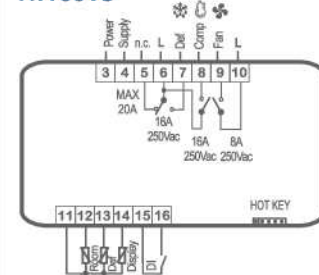



L: 38x185mm



LT: 38x185mm



K: OS/GS/8 DIN Rail

<b>XW60K</b>	Digital controller in split format for NT and LT with electrical or hot gas defrost function and fans
<b>XW70L</b>	Digital controller in split format for NT and LT with electrical or hot gas defrost function, fans and auxiliary relay
<b>XW70LT</b>	Digital controller for NT and LT with electrical or hot gas defrost function, fans and auxiliary relay, TOUCH interface and red, white or blue display
<b>XW70K</b>	Digital controller in split format for NT and LT with electrical or hot gas defrost function, fans, auxiliary relay and triac (ON/OFF)

FEATURES	XW60K	XW70L	XW70LT	XW70K
<b>Display: n° digits</b>	on keyboard ± 3 d.p.	± 3 d.p.	± 3 d.p.	on keyboard ± 3 d.p.
<b>Keyboard: push buttons</b>	6 (on CX620, TX620, T620T, VX620)	8	8	8 (on TX820, T820T, VX820)
<b>Power supply</b>	24, 110, 230Vac	24, 110, 230Vac	24, 110, 230Vac	24, 110, 230Vac
<b>Probe inputs</b>				
Thermostat	NTC, PTC	NTC, PTC	NTC, PTC	NTC, PTC
Defrost	NTC, PTC	NTC, PTC	NTC, PTC	NTC, PTC
Condenser	NTC, PTC	NTC, PTC	NTC, PTC	NTC, PTC
Display	NTC, PTC	NTC, PTC	NTC, PTC	NTC, PTC
<b>Digital inputs</b>				
Alarm, start defrost, door switch, pressure switch, probe	config	config	config	config
DI 2		config	config	config
<b>Relay outputs</b>				
Compressor	20A	20A	20A	20A
Defrost	16A	8A	16A	16A
Fans	8A	8A	8A	8A
Light	16A	8A, 16A	8A	16A
Alarm, AUX		8A	8A	
RL 6 configurable				
<b>Other</b>				
Hot Key/Prog Tool Kit output	pres	pres	pres	pres
Remote display output		X-REP opt	X-REP opt	
Serial output	TTL	TTL	TTL	TTL
Triac output				2A
Buzzer	on keyboard	opt	pres	on keyboard
Real time clock	opt	opt	opt	opt

### XW60K

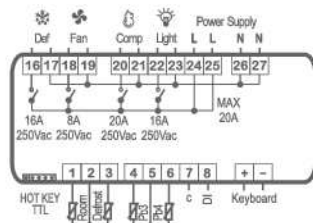

### XW70L

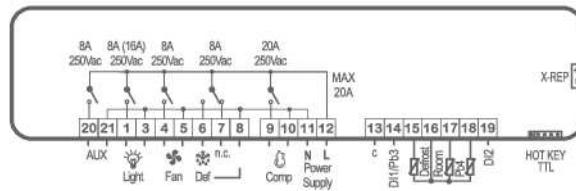

### XW70LT

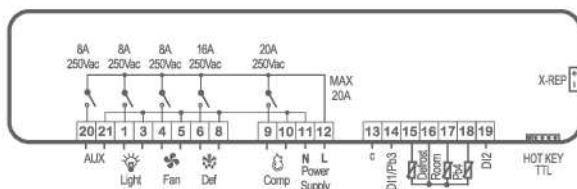

### XW70K

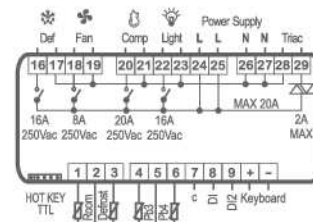



**XW90L** | Digital controller for NT and LT with electrical or hot gas defrost function, fans, auxiliary relay and sixth relay configurable

**XW90LT** | Digital controller for NT and LT with electrical or hot gas defrost function, fans, auxiliary relay and sixth relay configurable, TOUCH interface and red, white or blue display



L: 38x185mm



LT: 38x185mm

FEATURES	XW90L	XW90LT
<b>Display: n° digits</b>	± 3 d.p.	± 3 d.p.
<b>Keyboard: push buttons</b>	8	8
<b>Power supply</b>	24, 110, 230Vac	24, 110, 230Vac
<b>Probe inputs</b>		
Thermostat	NTC, PTC	NTC, PTC
Defrost	NTC, PTC	NTC, PTC
Condenser	NTC, PTC	NTC, PTC
Display	NTC, PTC	NTC, PTC
<b>Digital inputs</b>		
Alarm, start defrost, door switch, pressure switch, probe	config	config
DI 2	config	config
<b>Relay outputs</b>		
Compressor	20A	20A
Defrost	8A	16A
Fans	8A	8A
Light	8A, 16A	8A
Alarm, AUX	8A	8A
RL 6 configurable	8A	8A
<b>Other</b>		
Hot Key/Prog Tool Kit output	pres	pres
Remote display output	X-REP opt	X-REP opt
Serial output	TTL	TTL
Triac output		
Buzzer	opt	pres
Real time clock	opt	opt

## XW90L

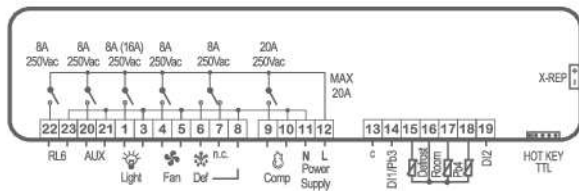

## XW90LT

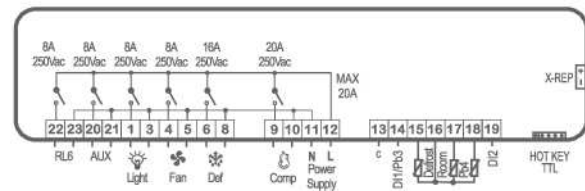



32x74mm



38x185mm



38x185mm



100x64mm

<b>CX620</b>	6 key keyboard (32x74mm) for controllers in K format
<b>TX620</b>	6 key keyboard (horizontal WING) for controllers in K format
<b>T620T</b>	6 key keyboard for controllers in K format with TOUCH interface and red, white and blue display
<b>VX620</b>	6 key keyboard (vertical WING) for controllers in K format
<b>TX820</b>	8 key keyboard (horizontal WING) for controllers in K format
<b>T820T</b>	8 key keyboard for controllers in K format with TOUCH interface and red, white and blue display
<b>VX820</b>	8 key keyboard (vertical WING) for controllers in K format

FEATURES	CX620	TX620	T620T	VX620	TX820	T820T	VX820
Display: n° digits	± 3 d.p.	± 3 d.p.	± 3 d.p.	± 3 d.p.	± 3 d.p.	± 3 d.p.	± 3 d.p.
Keyboard: push buttons	6	6	6	6	8	8	8
Power supply	from controller	from controller	from controller	from controller	from controller	from controller	from controller
Slave module	XW20K XW40K XW60K	XW20K XW40K XW60K	XW20K XW40K XW60K	XW20K XW40K XW60K	XW70K	XW70K	XW70K
Buzzer	opt	opt	pres	opt	opt	pres	opt

The keyboards CX, TX and VX are provided with a wide display with integrated icons of real time situation and measurement unit, for clear and continuous monitoring.



### The POWER MODULES in K FORMAT are AVAILABLE in 4 DIFFERENT VERSIONS

**OS:** open board



**GS:** with plastic housing 225x180x84mm



**8 DIN Rail base:** open board with 8 DIN bottom



**8 DIN Rail:** with 8 DIN plastic housing





# MULTIPLEXED CABINET REFRIGERATION CONTROLLERS

## SECTION INDEX

FUNCTIONS	MODELS	
<b>XM200/400/600 – NT and LT multiplexed applications</b>		<b>35</b>
Controllers for static or ventilated applications	XM244L – XM440K – XM460K XM470K	38
Controllers for ventilated applications with EEV management	XM660K – XM668D – XM669K XM670K – XM678D – XM679K	40
Keyboards for controllers in K format	CX640 – T640 – V640	42
Accessories	XM-RTC – XM-FC16 XM-FC21 – XM-FC26	42



## XM200/400/600 SERIES: NT and LT APPLICATIONS

- Multifunction controllers for multiplexed applications
- Multi-master devices (XM400/600)
- Up to 5 controllers linked for XM400 series and up to 8 for XM600 series
- Internal Real Time Clock
- Superheat adaptive control (XM600)
- Integrated ON/OFF or stepper electronic expansion valve drive (XM600)
- Anti-sweat heater management through a "DEW POINT" (XM600)
- Virtual probe management (XM600)
- Evaporating fans speed management via PWM or 4-20mA/0-10V (XM600)
- XM668D and XM678D models certified by Alco to be used combined with EX4, EX5, EX6 valves
- Keyboard with direct access to the main functions (also with TOUCH interface)
- Hot Key or Prog Tool Kit connector for quick and easy programming
- Serial connection to monitoring systems
- 10VA max power absorption
- Display with red LED (13,2 mm high), (10,5mm and icons for CX format and WING TOUCH)

### MULTIPLEXED CABINET APPLICATIONS with CONTROLLERS in K FORMAT

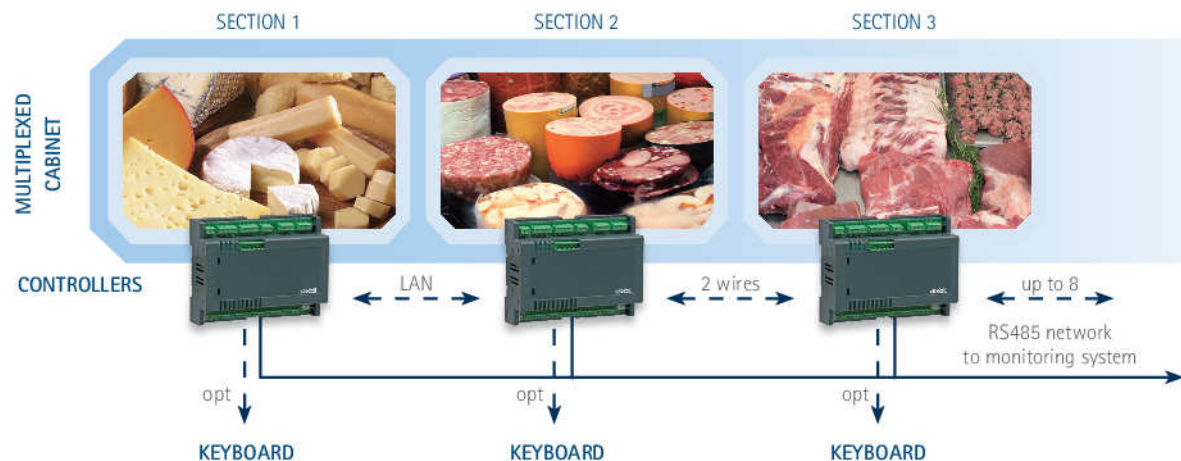

## HOW to ORDER

XM200L 

X	M	2	4	4	L	-	A	B	C	D	O
---	---	---	---	---	---	---	---	---	---	---	---

  For inox version and blue display please contact Dixell

A	B	C	D
<b>Power supply</b>	<b>RTC</b>	<b>Buzzer</b>	<b>Measurement unit</b>
4 = 110Vac 5 = 230Vac	0 = No 1 = Yes	0 = No 1 = Yes	C = °C F = °F

XM400K 

X	M	4			K	-	A	B	C	D	E
---	---	---	--	--	---	---	---	---	---	---	---

A	B	C	D	E
<b>Power supply</b>	<b>RTC</b>	<b>Housing</b>	<b>Measurement unit</b>	<b>RS485 output</b>
4 = 110Vac 5 = 230Vac	0 = No 1 = Yes	0 = Open board "OS" 1 = "GS" housing	C = °C F = °F	0 = No 1 = Yes

XM600D 

X	M	6			8	D	-	2	B	C	D	E
---	---	---	--	--	---	---	---	---	---	---	---	---

B	C	D	E		
<b>Inputs</b>	<b>RTC</b>	<b>RS485</b>	<b>Measurement unit</b>	<b>Modulating output</b>	<b>Connections</b>
N = NTC/4÷20mA O = NTC/0÷5V P = Pt1000/4÷20mA Q = Pt1000/0÷5V	0 = No 1 = No 2 = Yes 3 = Yes	No Yes No Yes	C = °C/Bar F = °F/PSI	0 = No 1 = No 2 = 4÷20mA/0÷10V 3 = 4÷20mA/0÷10V 4 = PWM 5 = PWM	Disconnectable + screw Screw Disconnectable + screw Screw Disconnectable + screw Screw

XM600K 

X	M	6			K	-	A	B	C	D	E
---	---	---	--	--	---	---	---	---	---	---	---

A	B	C	D	E			
<b>Power supply</b>	<b>Inputs</b>	<b>RTC</b>	<b>RS485</b>	<b>Housing</b>	<b>Measurement unit</b>	<b>Modulating output</b>	<b>Connections</b>
4 = 110Vac 5 = 230Vac	N = NTC/4÷20mA O = NTC/0÷5V P = Pt1000/4÷20mA Q = Pt1000/0÷5V	0 = No 1 = No 2 = Yes 3 = Yes 4 = No 5 = No 6 = Yes 7 = Yes	No Yes No Yes No Yes No Yes	8 DIN Rail 8 DIN Rail 8 DIN Rail 8 DIN Rail Open board Open board Open board Open board	C = °C/Bar F = °F/PSI	0 = No 1 = No 2 = 4÷20mA/0÷10V 3 = 4÷20mA/0÷10V 4 = PWM 5 = PWM	Disconnectable + screw Screw Disconnectable + screw Screw Disconnectable + screw Screw

T/V KEYBOARDS 

		4	0	-	A	0	0	D	0
--	--	---	---	---	---	---	---	---	---

  For inox version and blue display on T keyboard please contact Dixell

CX KEYBOARDS 

C	X	6	0	-	A	0	0	N	0
---	---	---	---	---	---	---	---	---	---

 For blue display please contact Dixell

A	D
<b>Buzzer</b>	<b>Measurement unit</b>
0 = No 1 = Yes	C = °C F = °F

## TOUCH KEYBOARDS

T	6	6	0	T	-	1	0	0	D	0
---	---	---	---	---	---	---	---	---	---	---

## TOUCH KEYBOARDS back-panel mounting

T	6	6	0	T	-	1	0	0	D	0	-	R
---	---	---	---	---	---	---	---	---	---	---	---	---

D
<b>Display</b>
N = Red R = Blue W = White

# XM200

## CONTROLLER for MULTIPLEXED VENTILATED APPLICATIONS



L: 38x185mm

**XM244L**

Digital controller in compact format for NT and LT ventilated applications with 4 defrost management

FEATURES	XM244L
Display: n° digits	± 3 d.p.
Keyboard: push buttons	5
Power supply	110, 230Vac
<b>Probe inputs</b>	
Thermostat	NTC
Defrost	NTC
Defrost 2	NTC
Defrost 3	NTC
Defrost 4	NTC
<b>Relay outputs</b>	
Compressor	8A
Defrost	8A
Defrost 2	8A
Defrost 3	8A
Defrost 4	8A
Fans	8A
<b>Other</b>	
Hot Key/Prog Tool Kit output	pres
Serial output	TTL
Buzzer	opt
Real time clock	opt

### XM244L

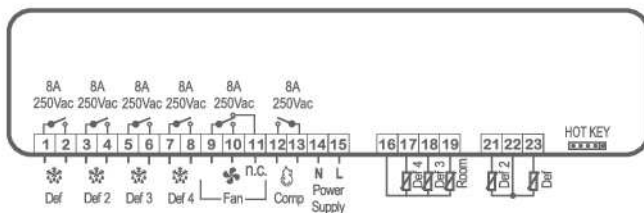

# CONTROLLERS for STATIC or VENTILATED MULTIPLEXED APPLICATIONS

# XM400

<b>XM440K</b>	Digital controller for NT and LT static applications
<b>XM460K</b>	Digital controller for NT and LT ventilated applications
<b>XM470K</b>	Digital controller for NT and LT ventilated applications with auxiliary output



K: OS/GS

FEATURES	XM440K	XM460K	XM470K
<b>Display: n° digits</b>	on keyboard ± 3 d.p.	on keyboard ± 3 d.p.	on keyboard ± 3 d.p.
<b>Keyboard: push buttons</b>	6 (on CX640, T640, V640)	6 (on CX640, T640, V640)	8 (on T840, V840)
<b>Power supply</b>	110, 230Vac	110, 230Vac	110, 230Vac
<b>Probe inputs</b>			
Thermostat	NTC	NTC	NTC
Defrost	NTC	NTC	NTC
Display	NTC	NTC	NTC
AUX			
Suction pressure			
Condensing pressure			
<b>Digital inputs</b>			
Start defrost, pressure switch, AUX, generic alarm, serious alarm mode, light, ON/OFF, holiday	config	config	config
Energy saving	pres	pres	pres
<b>Relay outputs</b>			
Compressor	8A	8A	8A
Defrost	20A	20A	20A
Fans		8A	8A
Light	16A	16A	16A
Alarm			
AUX			8A
<b>Other</b>			
Hot Key/Prog Tool Kit output	pres	pres	pres
Remote display output	X-REP	X-REP	X-REP
Serial output	TTL, RS485 opt	TTL, RS485 opt	TTL, RS485 opt
4÷20mA/0÷10V output			
PWM output			
Valve driver output			
Buzzer	on keyboard	on keyboard	on keyboard
Real time clock	opt	opt	opt
Connection kit			

**XM440K**

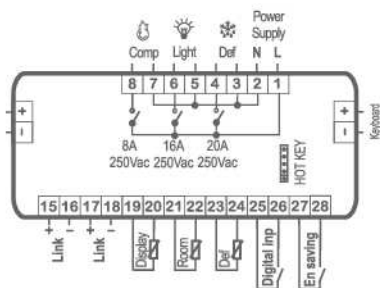

**XM460K**

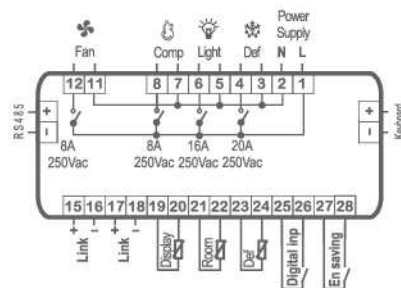

**XM470K**

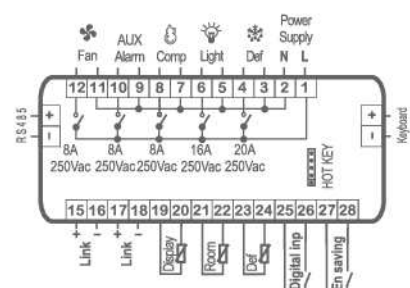

# XM600

## CONTROLLERS for VENTILATED MULTIPLEXED APPLICATIONS with EEV MANAGEMENT



K: OS/8 DIN Rail D: 8 DIN Rail

<b>XM660K</b>	Digital controller for NT and LT ventilated applications with high performance defrost
<b>XM668D</b>	Digital controller for NT and LT ventilated applications with high performance defrost and stepper electronic valve management
<b>XM669K</b>	Digital controller for NT and LT ventilated applications with high performance defrost and ON/OFF electronic valve management

FEATURES	XM660K	XM668D	XM669K																																															
<b>Display:</b> n° digits	on keyboard ± 3 d.p.	on keyboard ± 3 d.p.	on keyboard ± 3 d.p.																																															
<b>Keyboard:</b> push buttons	6 (on CX660, T660T)	6 (on CX660, T660T)	6 (on CX660, T660T)																																															
<b>Power supply</b>	110, 230Vac	24Vac	110, 230Vac																																															
<b>Probe inputs</b>																																																		
Thermostat	NTC, Pt1000	NTC, Pt1000	NTC, Pt1000																																															
Defrost	NTC, Pt1000	NTC, Pt1000	NTC, Pt1000																																															
Display	NTC, Pt1000	NTC, Pt1000	NTC, Pt1000																																															
AUX	NTC, Pt1000	NTC, Pt1000	NTC, Pt1000																																															
Suction pressure		NTC, Pt1000, 4÷20mA, 0÷5V	NTC, Pt1000, 4÷20mA, 0÷5V																																															
Condensing pressure		NTC, Pt1000	NTC, Pt1000																																															
<b>Digital inputs</b>																																																		
Start defrost, pressure switch, AUX, generic alarm, serious alarm mode, light, ON/OFF, holiday	2 x config	3 x config	2 x config																																															
Energy saving																																																		
<b>Relay outputs</b>																																																		
Compressor/Valve	8A	8A	8A																																															
Defrost	16A	16A	16A																																															
Fans	8A	8A	8A																																															
Light	16A	16A </tr <tr> <td>Alarm</td> <td></td> <td></td> <td></td> </tr> <tr> <td>AUX</td> <td></td> <td></td> <td></td> </tr> <tr> <td><b>Other</b></td> <td></td> <td></td> <td></td> </tr> <tr> <td>Hot Key/Prog Tool Kit output</td> <td>pres</td> <td>pres</td> <td>pres</td> </tr> <tr> <td>Remote display output</td> <td>X-REP</td> <td>X-REP</td> <td>X-REP</td> </tr> <tr> <td>Serial output</td> <td>RS485 opt</td> <td>RS485 opt</td> <td>RS485 opt</td> </tr> <tr> <td>4÷20mA/0÷10V output</td> <td>opt</td> <td>opt</td> <td>opt</td> </tr> <tr> <td>PWM output</td> <td>opt</td> <td>opt</td> <td>opt</td> </tr> <tr> <td>Valve driver output</td> <td></td> <td>stepper</td> <td>ON/OFF up to 30W</td> </tr> <tr> <td>Buzzer</td> <td>on keyboard</td> <td>on keyboard</td> <td>on keyboard</td> </tr> <tr> <td>Real time clock</td> <td>pres</td> <td>pres</td> <td>pres</td> </tr> <tr> <td>Connection kit</td> <td>XM-FC16</td> <td>XM-FC26</td> <td>XM-FC21</td> </tr>	Alarm				AUX				<b>Other</b>				Hot Key/Prog Tool Kit output	pres	pres	pres	Remote display output	X-REP	X-REP	X-REP	Serial output	RS485 opt	RS485 opt	RS485 opt	4÷20mA/0÷10V output	opt	opt	opt	PWM output	opt	opt	opt	Valve driver output		stepper	ON/OFF up to 30W	Buzzer	on keyboard	on keyboard	on keyboard	Real time clock	pres	pres	pres	Connection kit	XM-FC16	XM-FC26	XM-FC21
Alarm																																																		
AUX																																																		
<b>Other</b>																																																		
Hot Key/Prog Tool Kit output	pres	pres	pres																																															
Remote display output	X-REP	X-REP	X-REP																																															
Serial output	RS485 opt	RS485 opt	RS485 opt																																															
4÷20mA/0÷10V output	opt	opt	opt																																															
PWM output	opt	opt	opt																																															
Valve driver output		stepper	ON/OFF up to 30W																																															
Buzzer	on keyboard	on keyboard	on keyboard																																															
Real time clock	pres	pres	pres																																															
Connection kit	XM-FC16	XM-FC26	XM-FC21																																															

### XM660K

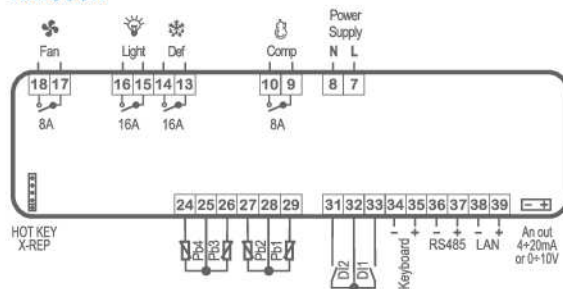

### XM668D

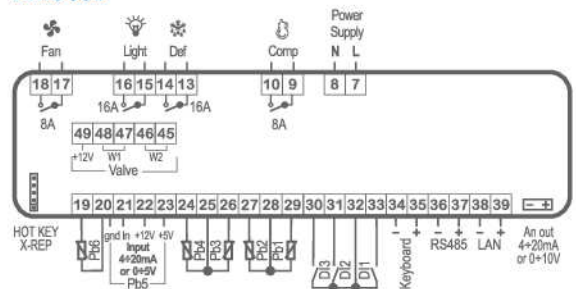

### XM669K

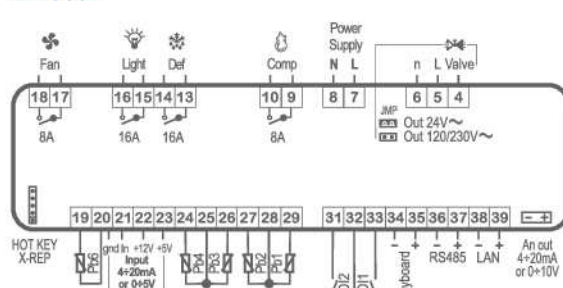



# CONTROLLERS for VENTILATED MULTIPLEXED APPLICATIONS with EEV MANAGEMENT

# XM600

<b>XM670K</b>	Digital controller for NT and LT ventilated applications with high performance defrost and auxiliary and alarm outputs
<b>XM678D</b>	Digital controller for NT and LT ventilated applications with high performance defrost, stepper electronic valve management and auxiliary and alarm outputs
<b>XM679K</b>	Digital controller for NT and LT ventilated applications with high performance defrost, ON/OFF electronic valve management and auxiliary and alarm outputs



K: OS/8 DIN Rail    D: 8 DIN Rail

FEATURES	XM670K	XM678D	XM679K
<b>Display: n° digits</b>	on keyboard ± 3 d.p.	on keyboard ± 3 d.p.	on keyboard ± 3 d.p.
<b>Keyboard: push buttons</b>	6 (on CX660, T660T)	6 (on CX660, T660T)	6 (on CX660, T660T)
<b>Power supply</b>	110, 230Vac	24Vac	110, 230Vac
<b>Probe inputs</b>			
Thermostat	NTC, Pt1000	NTC, Pt1000	NTC, Pt1000
Defrost	NTC, Pt1000	NTC, Pt1000	NTC, Pt1000
Display	NTC, Pt1000	NTC, Pt1000	NTC, Pt1000
AUX	NTC, Pt1000	NTC, Pt1000	NTC, Pt1000
Suction pressure		NTC, Pt1000, 4÷20mA, 0÷5V	NTC, Pt1000, 4÷20mA, 0÷5V
Condensing pressure		NTC, Pt1000	NTC, Pt1000
<b>Digital inputs</b>			
Start defrost, pressure switch, AUX, generic alarm, serious alarm mode, light, ON/OFF, holiday	3 x config	3 x config	3 x config
Energy saving			
<b>Relay outputs</b>			
Compressor/Valve	5A	5A	5A
Defrost	16A	16A	16A
Fans	8A	8A	8A
Light	16A	16A	16A
Alarm	8A	8A	8A
AUX	8A	8A	8A
<b>Other</b>			
Hot Key/Prog Tool Kit output	pres	pres	pres
Remote display output	X-REP	X-REP	X-REP
Serial output	RS485 opt	RS485 opt	RS485 opt
4÷20mA/0÷10V output	opt	opt	opt
PWM output	opt	opt	opt
Valve driver output		stepper	ON/OFF up to 30W
Buzzer	on keyboard	on keyboard	on keyboard
Real time clock	pres	pres	pres
Connection kit	XM-FC16	XM-FC26	XM-FC21

## XM670K

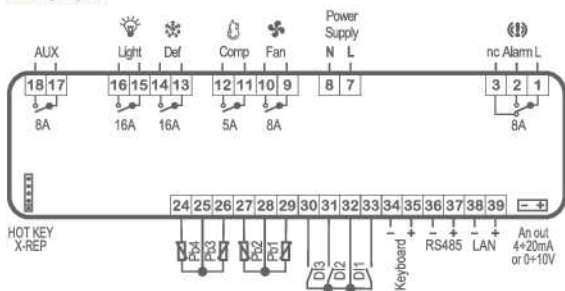

## XM678D

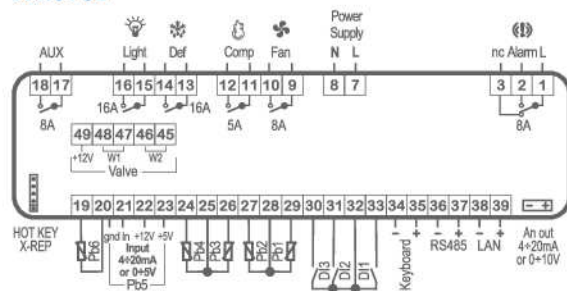

## XM679K

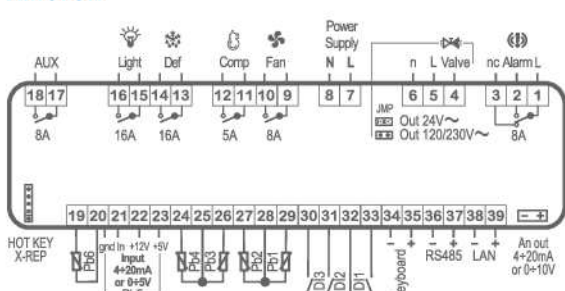

# XM400/600

## KEYBOARDS for CONTROLLERS in K FORMAT



<b>CX640</b>	6 key keyboard (32x74mm) for XM400 controllers
<b>T640</b>	6 key keyboard (horizontal WING) for XM400 controllers
<b>V640</b>	6 key keyboard (vertical WING) for XM400 controllers
<b>CX660</b>	6 key keyboard (32x74mm) for XM600 controllers
<b>T660T</b>	6 key keyboard for XM600 controllers with TOUCH interface and red, white or blue display
<b>T840</b>	8 key keyboard (horizontal WING) for XM400 controllers
<b>V840</b>	8 key keyboard (vertical WING) for XM400 controllers

FEATURES	CX640	T640	V640	CX660	T660T	T840	V840
<b>Display: n° digits</b>	± 3 d.p.	± 3 d.p.	± 3 d.p.	± 3 d.p.	± 3 d.p.	± 3 d.p.	± 3 d.p.
<b>Keyboard: push buttons</b>	6	6	6	6	6	8	8
<b>Power supply</b>	from controller	from controller	from controller	from controller	from controller	from controller	from controller
<b>Slave module</b>	XM440K XM460K	XM440K XM460K	XM440K XM460K	XM660K XM668D XM669K XM670K XM678D XM679K	XM660K XM668D XM669K XM670K XM678D XM679K	XM470K	XM470K
<b>Buzzer</b>	opt	opt	opt	opt	pres	opt	opt

CX and TOUCH keyboards are provided with a wide display with integrated icons of real time situation and of measurement unit, for clear and continuous monitoring.



### The POWER MODULES in K FORMAT are AVAILABLE in 3 DIFFERENT VERSIONS

**OS:** open board for XM400 and XM600



**GS:** standard plastic case for XM400



**8 DIN Rail:** with plastic housing for XM600



### ACCESSORIES

#### XM-RTC

Real time clock standard board for XM400



#### XM-FC16

Female connector kit 16 pins for XM660K and XM670K

#### XM-FC21

Female connector kit 21 pins for XM669K and XM679K

#### XM-FC26

Female connector kit 26 pins for XM668D and XM678D





# ELECTRONIC EXPANSION VALVE DRIVERS

## SECTION INDEX

FUNCTIONS	MODELS	
<b>XEV – superheat regulation</b>		<b>43</b>
Drivers for ON/OFF expansion valve management	XEV11D – XEV12D	46
Drivers for stepper electronic expansion valve management	XEV21D – XEV22D	46
Driver for electronic expansion valve management with sub-cooling management	XEV32D	46
Keyboard for XEV11D and XEV21D controllers	KB1 PRG	46
Accessory	CAB/KB11	46



D: 4 DIN Rail



100x64mm

## XEV SERIES: SUPERHEAT REGULATION

- Drivers for ON/OFF (pulsed) and stepper electronic expansion valve management
- ON/OFF (pulsed) expansion valve support with 30W max power and coil c.a.
- Temperature analog inputs (NTC, PTC, Pt1000)
- Pressure analog inputs (0÷5V, 4÷20mA)
- Possibility to broadcast via LAN the pressure signal to multiplexed cabinets
- Alarm management (visual, relay)
- Cool Defrost for defrost time reduction
- Superheat adaptive control
- Sub-cooling management (XEV32D)
- Hot Key or Prog Tool Kit connector for quick and easy programming
- Serial connection to monitoring systems
- 20VA max power absorption
- Display with red LED (10,5mm high) and icons

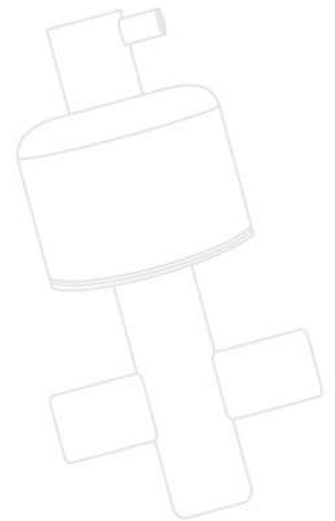

### HOW to ORDER

XEV11/12D	X	E	V	1	D	-	A	B	C	D	E
XEV21/22/32D	X	E	V		D	-	1	B	C	D	0

A	B	C	D	E
<b>Power supply</b>	<b>Temperature probe</b>	<b>Pressure probe</b>	<b>Measurement unit</b>	<b>Buzzer</b>
2 = 24Vac	P = Pt1000	0 = 0÷5V	C = °C/Bar	0 = No
4 = 110Vac	N = NTC	1 = 4÷20mA	F = °F/PSI	1 = Yes
5 = 230Vac		2 = PP11		
		3 = PP30		
		4 = PPR15		
		5 = PPR30		

## SUB-COOLING

During the refrigeration cycle shown in the following diagram, the temperature of the liquid refrigerant entering by the thermostatic valve is important. Decreasing this value results in many economic advantages because it increases the "refrigerating effect" ( $h_2-h_1$ ). For this reason it's important to introduce the concept of sub-cooling of the refrigerating fluid as "saturated liquid". This process, if properly managed, can improve LT plant operation (also more than 25%), against a meagre power of the NT compressor rack (about 8%) and an appropriate exchanger. The XEV32D driver, thanks to special algorithms, ensures the sub-cooling optimization, which increases the plant COP (Coefficient Of Performance). Screens show as, with the same compressor, the sub-cooling management increase the refrigeration power (COP increasing). For this reason it's possible to consider the use of a smaller compressor (less absorbed power).

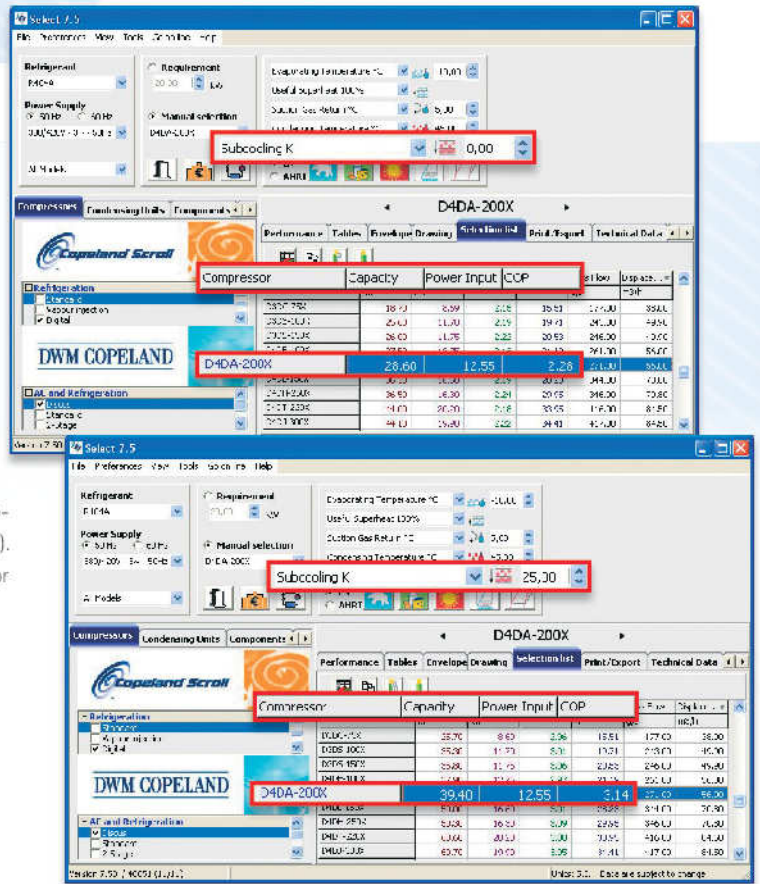
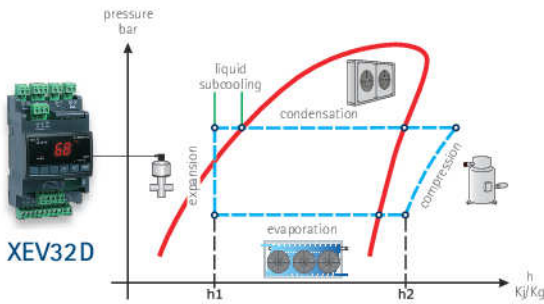

Pressure-enthalpy diagram shows the refrigeration cycle and the sub-cooling zone.

## REFRIGERATION CIRCUIT

The diagram shows the different ways to connect the XEV drivers to a generic application like a single cooling unit or multiplexed cabinet. The valve is driven by the XEV module that is in turn commanded, by the activation of the digital input, from the temperature controller.

**SINGLE SYSTEM:** section 1 of the schematic diagram shows how connections would be arranged for a single cooling system.

**MULTIPLXED CABINET:** to reduce installation costs, it is possible to use a single suction pressure transducer as shown in the overall schematic diagram. This transducer's pressure signal is repeated to the other controllers across a digital LAN connection that guarantees optimal noise immunity.

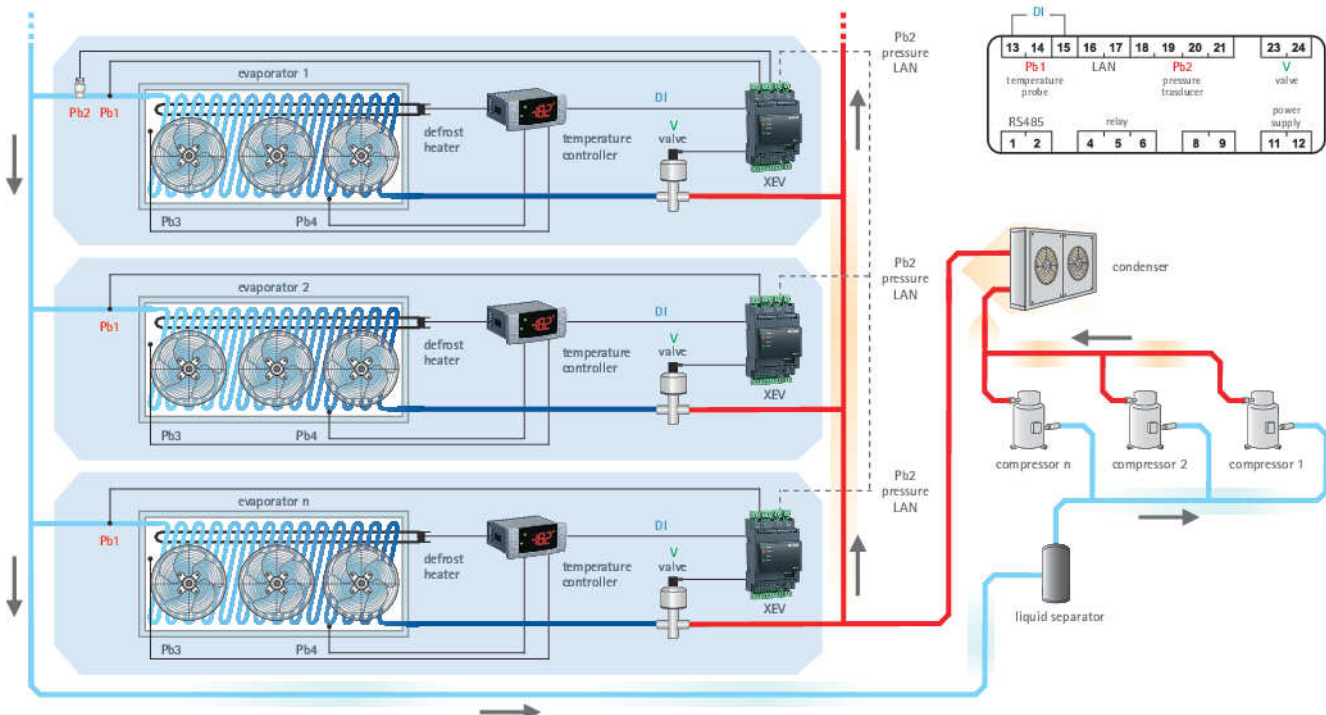



D: 4 DIN Rail



100x64mm

<b>XEV11D</b>	ON/OFF electronic expansion valve driver
<b>XEV12D</b>	ON/OFF electronic expansion valve driver with integrated display
<b>XEV21D</b>	Stepper electronic expansion valve driver
<b>XEV22D</b>	Stepper electronic expansion valve driver with integrated display
<b>XEV32D</b>	Stepper electronic expansion valve driver with integrated display and sub-cooling management
<b>KB1 PRG</b>	Programming keyboard for XEV11D and XEV21D modules

FEATURES	XEV11D	XEV12D	XEV21D	XEV22D	XEV32D	KB1 PRG
<b>Display: n° digits</b>		± 3 d.p.		± 3 d.p.	± 3 d.p.	± 3 d.p.
<b>Keyboard: push buttons</b>		3		3	3	6
<b>Power supply</b>	24, 110, 230Vac	24, 110, 230Vac	24Vac/dc	24Vac/dc	24Vac/dc	from controller
<b>Probe inputs</b>						
Suction pressure	4±20mA, 0÷5V	4± 20mA, 0÷5V	4±20mA, 0÷5V	4±20mA, 0÷5V	4±20mA, 0÷5V	
Suction temperature	NTC, Pt1000	NTC, Pt1000	NTC, Pt1000	NTC, Pt1000	NTC, Pt1000	
Output liquid temperature					NTC, Pt1000	
<b>Digital inputs</b>						
Free of voltage	pres	pres	pres	pres	pres	
High voltage	pres	pres	pres	pres	pres	
<b>Relay outputs</b>						
Alarm	8A config	8A config	8A config	8A config	8A config	
<b>Other</b>						
Valve driver output	ON/OFF up to 30W	ON/OFF up to 30W	stepper	stepper	stepper	
Hot Key/Prog Tool Kit output	pres	pres	pres	pres	pres	
Remote keyboard output	KB1 PRG		KB1 PRG			
Serial output	RS485	RS485	RS485	RS485	RS485	
Alarm recovery by LAN	pres	pres	pres	pres	pres	
Buzzer	opt	opt				
Battery backup input			pres	pres	pres	

### XEV11D – XEV12D

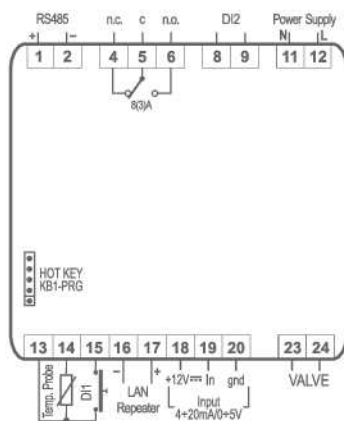

### XEV21D – XEV22D

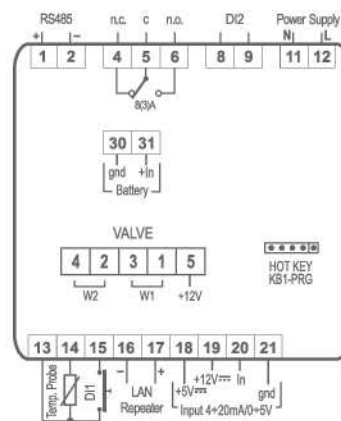

### XEV32D

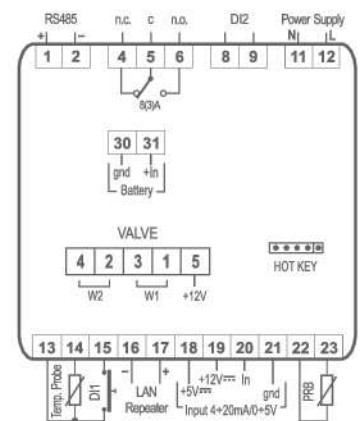

### ACCESSORY

#### CAB/KB11

Cable for the connection between the keyboard and the XEV driver, 1m





# ROOM CONTROLLERS

## SECTION INDEX

FUNCTIONS	MODELS	
<b>XLR100 COOL MATE – NT and LT applications</b>		<b>48</b>
Controller for NT refrigerated rooms	XLR130	49
Controller for NT and LT refrigerated rooms	XLR170	49
<b>XLR400 COOL MATE – NT and LT applications with dual temperature management</b>		<b>50</b>
Controller with dual temperature management for NT and LT refrigerated rooms	XLR460	51
Controller with dual temperature management for LT refrigerated rooms	XLR470	51
<b>XLH200/300 COOL MATE – NT and LT applications and maturing rooms with temperature/humidity management</b>		<b>52</b>
Controller for NT and LT refrigerated rooms with temperature and humidity management	XLH260	53
Controller for maturing rooms with temperature and humidity management	XLH360	53
<b>V-KIT – NT and LT applications – split format</b>		<b>54</b>
Wall adapter for WING vertical keyboards	V-KIT	54



230x210mm



## COOL MATE

### XLR100 COOL MATE SERIES: NT and LT APPLICATIONS

- Advanced multifunction refrigeration controllers suitable for both heating and cooling applications
- Temperature control can be performed on probe 1, probe 2 or by the difference between probe 1 and 2
- Complete compressor and defrost management
- Maximum and minimum temperature recording
- Direct line power supply 230 (110)Vac. No external transformer required
- Instant visibility of machine status via display icons
- Clear alarm signals thanks to the front lid
- Fast and easy wiring
- Designed to be wall or panel mounted
- Hot Key or Prog Tool Kit connector for quick and easy programming
- Serial connection to monitoring systems
- 10VA max power absorption
- Display with red LED (30,5mm high) and 11 icons

#### HOW to ORDER

XLR100 X L R 1 0 - A B C D E  For blue display please contact Dixell

A	B	C	D	E
<b>Power supply</b>	<b>Inputs/kind of output</b>	<b>RTC</b>	<b>Measurement unit</b>	<b>RS485 output</b>
2 = 24Vac 4 = 110Vac 5 = 230Vac	N = NTC/standard P = PTC/standard O = NTC/direct loads Q = PTC/direct loads	1 = No 3 = Yes	C = °C F = °F	2 = No 3 = Yes



- XLR130** | "off cycle" defrost digital controller for NT
- XLR170** | Digital controller for NT and LT ventilated applications



230x210mm

FEATURES	XLR130	XLR170
<b>Display: n° digits</b>	± 3 d.p.	± 3 d.p.
<b>Keyboard: push buttons</b>	8	8
<b>Power supply</b>	24, 110, 230Vac	24, 110, 230Vac
<b>Probe inputs</b>		
Thermostat	NTC, PTC	NTC, PTC
Defrost		NTC, PTC
Display	NTC, PTC	NTC, PTC
<b>Digital inputs</b>		
Alarm, block alarm, pressure switch, start defrost, energy saving, ON/OFF, AUX, holiday	config	config
Door switch	pres	pres
<b>Relay outputs</b>		
Compressor	20A	20A
Defrost		16A
Fans		8A
Light	16A	16A
AUX	20A	20A
Alarm	8A	8A
<b>Other</b>		
Hot Key/Prog Tool Kit output	pres	pres
Serial output	RS485 opt	RS485 opt
Buzzer	pres	pres
Real time clock	opt	opt

## XLR130

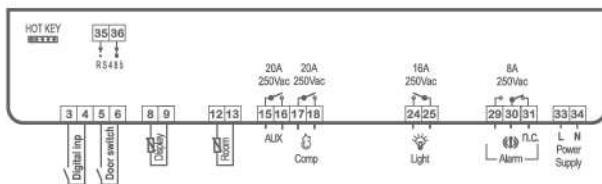

## XLR130 direct loads

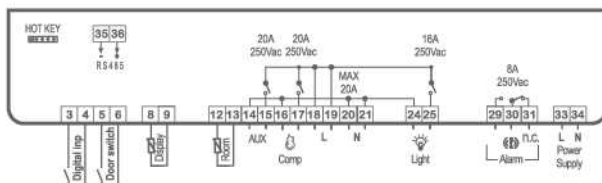

## XLR170

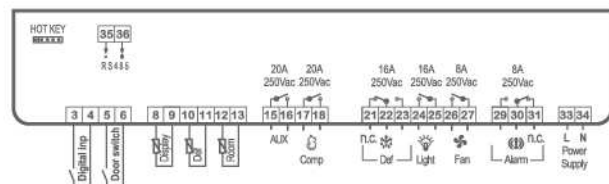

## XLR170 direct loads

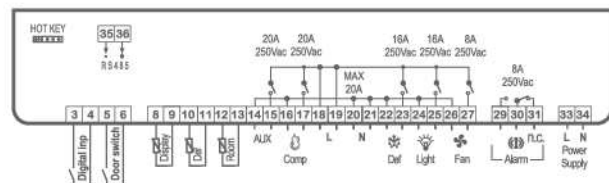



230x210mm



## COOL MATE

### XLR400 COOL MATE SERIES: NT and LT APPLICATIONS with DUAL TEMPERATURE MANAGEMENT

- Advanced multifunction refrigeration controllers with dual temperature management
- Ideal for heating-cooling applications such as a heated bain-marie counter with refrigerated under-counter storage
- Designed for a dual refrigeration circuit or 2 independent circuits
- Integrated defrost management
- Cooling or heating action selectable by user
- Direct line power supply 230 (110)Vac. No external transformer required
- Instant visibility of machine status via display icons
- Fast and easy wiring
- Designed to be wall or panel mounted
- Hot Key or Prog Tool Kit connector for quick and easy programming
- Serial connection to monitoring systems
- 10VA max power absorption
- Dual display with red LED (25,3mm high) and yellow LED (20,3mm high) and 13 icons

#### TYPICAL APPLICATIONS

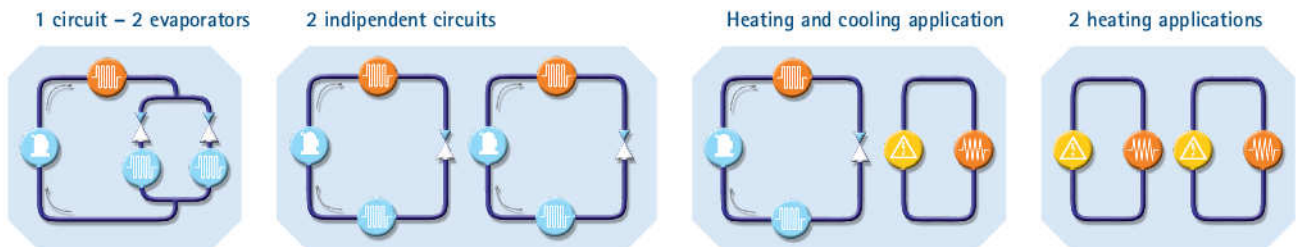

#### HOW to ORDER

XLR400 X L R 4 0 - A O C D E

A	C	D	E
<b>Power supply</b>	<b>RTC</b>	<b>Measurement unit</b>	<b>RS485 output</b>
2 = 24Vac	0 = No	C = °C	0 = No
4 = 110Vac	1 = Yes	F = °F	1 = Yes
5 = 230Vac			

# CONTROLLERS with DUAL TEMPERATURE MANAGEMENT for NT and LT COLD ROOMS

# XLR400

**XLR460** | Digital controller for NT and LT cold rooms with dual temperature management

**XLR470** | Digital controller for LT and LT cold rooms with dual temperature management



230x210mm

FEATURES	XLR460	XLR470
<b>First display: n° digits</b>	± 3 d.p.	± 3 d.p.
<b>Second display: n° digits</b>	± 4 d.p.	± 4 d.p.
<b>Keyboard: push buttons</b>	8	8
<b>Power supply</b>	24, 110, 230Vac	24, 110, 230Vac
<b>Probe inputs</b>		
Thermostat	NTC	NTC
Thermostat 2	NTC	NTC
Defrost	NTC	NTC
Defrost 2		NTC
<b>Digital inputs</b>		
Alarm, block alarm, pressure switch, start defrost, energy saving, ON/OFF, AUX, holiday	config	config
Door switch	pres	pres
<b>Relay outputs</b>		
Compressor	20A	20A
Compressor 2	20A	20A
Defrost	16A	16A
Defrost 2		5A
Fans	8A	5A
Fans 2		5A
Light	16A	16A
Alarm	8A	8A
<b>Other</b>		
Hot Key/Prog Tool Kit output	pres	pres
Serial output	RS485 opt	RS485 opt
Buzzer	pres	pres
Real time clock	opt	opt

## XLR460

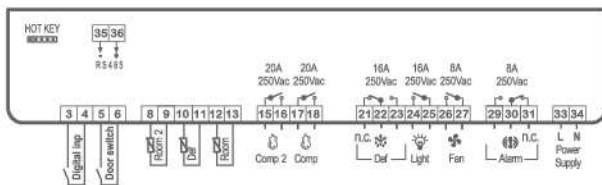

## XLR470

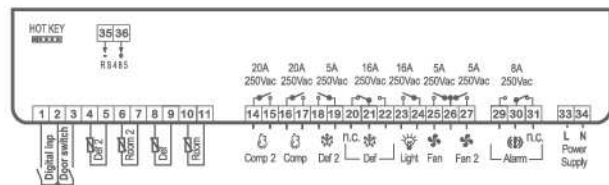



230x210mm



## COOL MATE

### XLH200/300 COOL MATE SERIES: NT and LT APPLICATIONS and MATURING ROOMS with TEMPERATURE/HUMIDITY MANAGEMENT

- Advanced multifunction controllers with temperature and humidity management
- Cooling and heating action for safe storage of products
- Defrost management
- Possibility of excluding humidity control
- Dehumidifying action by cooling circuit
- Running and stopping programmable cycles with different set points (XLH300)
- Automatic cycles of extraction fans (XLH300)
- Direct line power supply 230 (110)Vac. No external transformer required
- Instant visibility of machine status via display icons
- Fast and easy wiring
- Designed to be wall or panel mounted
- Hot Key or Prog Tool Kit connector for quick and easy programming
- Serial connection to monitoring systems
- 10VA max power absorption
- Dual display with red LED (25,3mm high) and yellow LED (20,3mm high) and 17 icons

#### HOW to ORDER

XLH200/300 X L H 6 0 - A 0 0 D E

A	D	E
<b>Power supply</b>	<b>Measurement unit</b>	<b>RS485 output</b>
2 = 24Vac	C = °C	0 = No
4 = 110Vac	F = °F	1 = Yes
5 = 230Vac		

# CONTROLLERS with TEMPERATURE/HUMIDITY MANAGEMENT for NT and LT COLD ROOMS and MATURING ROOMS

# XLH200/300

**XLH260** | Digital controller for NT and LT cold rooms with temperature and humidity management

**XLH360** | Digital controller for maturing rooms with temperature and humidity management and timed cycles



230x210mm

FEATURES	XLH260	XLH360
<b>First display: n° digits</b>	± 3 d.p.	± 3 d.p.
<b>Second display: n° digits</b>	± 4 d.p.	± 4 d.p.
<b>Keyboard: push buttons</b>	6	8
<b>Power supply</b>	24, 110, 230Vac	24, 110, 230Vac
<b>Probe inputs</b>		
Thermostat	NTC	NTC
Defrost	NTC	NTC
Humidity	4÷20mA	4÷20mA
<b>Digital inputs</b>		
Alarm, block alarm, pressure switch, start defrost, energy saving, ON/OFF, AUX, holiday	config	config
Door switch	pres	pres
<b>Relay outputs</b>		
Compressor	20A	20A
Defrost	16A	
Defrost, extractor fans		16A config
Fans	8A	8A
Heater control	20A	20A
Humidifying	8A	8A
Dehumidifying, light	16A config	16A config
<b>Other</b>		
Hot Key/Prog Tool Kit output	pres	pres
Serial output	RS485 opt	RS485 opt
Buzzer	pres	pres

## XLH260

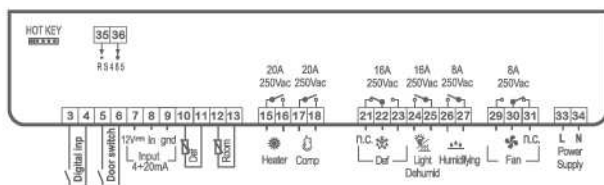

## XLH360

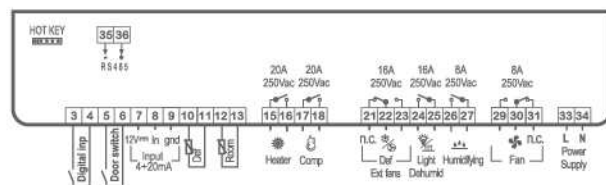



100x64mm

## V-KIT: NT and LT APPLICATIONS – SPLIT FORMAT

**V-KIT:** a wall/panel mounting housing kit for WING vertical keyboards. For remote connection to WING K controllers.

- Designed for cold rooms applications
- IP55 against water sprinkles
- Easy and quick to install

The Dixell V-KIT allows the user to mount the keyboard near to the cold-room door. Connection between the power board (eg. XW60K) and the keyboard is via a 2 core cable. The maximum distance possible is 100m. The door-switch facility is activated when the door is open, the light is automatically switched on, while the compressor, up to 1.5HP, and the evaporator fan can be simultaneously stopped.

The elegant design of this housing gives a quick and effective solution for a variety of different applications, such as cold-rooms, benches and industrial environments where it is difficult to mount the keyboard on a wall. It's available in white and black colours making it suitable for all applications, even where appearance plays part. A main feature is ease of assembly and with IP55 protection, it can be used in environments that may be subject to water spray or rigorous cleaning routines.

**The V-KIT is suitable for all vertical format keyboards.**

For more information about keyboards and WING modules, please check the information regarding WING series.



# CONTROLLERS for SPECIAL REFRIGERATED APPLICATIONS

## SECTION INDEX

FUNCTIONS	MODELS	
<b>XRБ – bottle cooler applications</b>		<b>56</b>
Controller for static applications	XRБ04СХ	57
Controllers for ventilated applications	XRБ06СХ – XRБ07СХ	57
<b>XB500 – blast chiller and temperature maintenance applications</b>		<b>58</b>
Blast chiller controller	XB570L	59
<b>XH200/300 – NT and LT refrigerated and maturing rooms applications with temperature/humidity management</b>		<b>60</b>
Controllers and keyboards for NT and LT refrigerated rooms	XH240K – TH620 – VH620 XH260L – XH260V	62
Controllers for maturing rooms	XH360L – XH360V	63
<b>XR400 – NT and LT applications with dual temperature management</b>		<b>64</b>
Controller for static applications	XR420C	65
Controller for ventilated applications	XR460C	65
<b>XR700 – NT and LT applications with HACCP function</b>		<b>66</b>
Controller with HACCP function for ventilated applications	XR775C	67
<b>XDL – temperature and status recording</b>		<b>68</b>
Temperature and status recording module	XDL01	69
Probe and status acquisition module	XJDL40D	69
Temperature recording kit	XDL01-PW-KIT – XDL01-XJ-KIT XDL01-XJB-KIT	69
Accessories	PW-DL – BA6H – BA24H – XDL-KEY	69
<b>XW700 – pharmaceutical applications</b>		<b>70</b>
Controllers and graphic display for ventilated pharmaceutical applications	XW737K – XW777K – VGW870	71
Accessories	XDL-KEY – CAB-USB10	71
<b>XR20/60 &amp; XW20/60/300 – NT and LT refrigerated truck applications</b>		<b>72</b>
Controller for static applications	XR20СХ – XW20L	73
Controllers for ventilated applications	XR60СХ – XW60L	73
Controllers and keyboard for ventilated applications with "on demand" defrost	XW360K – XW370K – T630	74



CX: 32x74mm



## XRB SERIES: BOTTLE COOLER APPLICATIONS

- Electronic controllers for bottle cooler
- Easy and intuitive installation
- High energy saving thanks to load optimization
- Algorithms for energy saving work without the use of external sensors
- Energy saving based on pre-set time interval
- Automatic set point management after filling the cabinet
- Compressor working time control
- Counters of compressor/defrost/fans/light activation time
- Condenser monitor for maintenance management
- Anti-sweat heaters management (only for XRB07CX)
- Firmware update via special Prog Key
- Hot Key or Prog Tool Kit connector for quick and easy programming
- Serial connection to monitoring systems
- 3VA max power absorption
- Display with red LED (10,5mm high) and icons



For cabinets with or without door  
(also with night curtains)

### HOW to ORDER

XRB 

X	R	B	O	C	X	-	A	N	C	D	E
---	---	---	---	---	---	---	---	---	---	---	---

 For blue display please contact Dixell



For RTC version please contact Dixell

A	C	D	E
<b>Power supply</b>	<b>Buzzer</b>	<b>Measurement unit</b>	<b>Connections</b>
0 = 12Vac/dc	0 = No	C = °C	3 = Screw
4 = 110Vac	1 = Yes	F = °F	9 = Disconnectable
5 = 230Vac			



# CONTROLLERS for STATIC or VENTILATED BOTTLE COOLER APPLICATIONS

# XRB

<b>XRBO4CX</b>	Digital controller for static applications
<b>XRBO6CX</b>	Digital controller for ventilated applications
<b>XRBO7CX</b>	Digital controller for ventilated applications with auxiliary output



CX: 32x74mm

FEATURES	XRBO4CX	XRBO6CX	XRBO7CX
<b>Display: n° digits</b>	± 3 d.p.	± 3 d.p.	± 3 d.p.
<b>Power supply</b>	12Vac/dc 110, 230Vac	12Vac/dc 110, 230Vac	110, 230Vac
<b>Probe inputs</b>			
Thermostat	NTC	NTC	NTC
Defrost	NTC	NTC	NTC
Condenser	NTC	NTC	NTC
Condenser/AUX			NTC on HOT KEY
<b>Digital inputs</b>			
Start defrost, light, AUX, door switch, energy saving, probe	config	config	config
Alarm, start defrost, light, AUX, door switch, energy saving, fans, ON/OFF	config	config	config
<b>Relay outputs</b>			
Compressor	16A	16A	16A
Fans		8A	8A
Light	8A	8A	8A
AUX			5A
<b>Other</b>			
Hot Key/Prog Tool Kit output	pres	pres	pres
Serial output	TTL	TTL	TTL
Buzzer	opt	opt	opt

## XRBO4CX

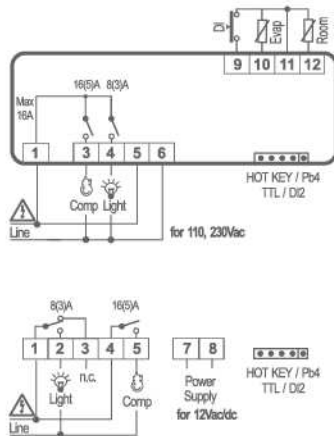

## XRBO6CX

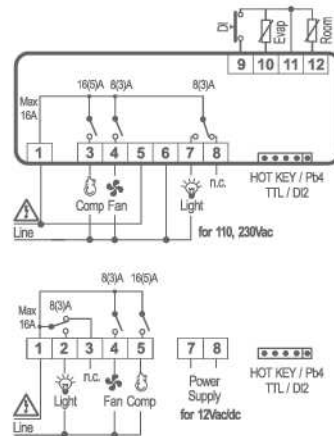

## XRBO7CX

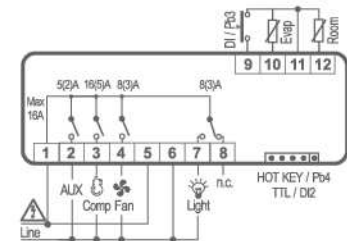



L: 38x185mm

## XB500: BLAST CHILLER and TEMPERATURE MAINTENANCE APPLICATIONS

- Blast chiller controllers that comply with the rules concerning preparation and chilling of foodstuffs (HACCP)
- Four configurable cycles pre-set
- Output for remote display to monitor the core temperature of goods
- Printer output (XB07PR) for temperature and blast chiller cycles reports
- All different phases monitored and shown on the display
- Real time clock
- Hot Key 128 or Prog Tool Kit connector for quick and easy programming
- Serial connection to monitoring systems
- 5VA max power absorption
- Dual display with red LED (8,0mm high) and yellow LED (5,6mm high) and 14 icons

```

* START CYCLE 3
DATE : 13/04/2012
PROBES REPORT 15:19
Insr. Probe : - 1.4°C
Room Probe : -22.6°C
PROBES REPORT 15:20
Insr. Probe : - 2.4°C
Room Probe : -22.6°C
START PHASE 1 15:20
Room SET : -30.0°C
I. Prb SET : -18.0°C
TIME : 240 min
PROBES REPORT 15:25
Insr. Probe : - 2.8°C
Room Probe : -22.6°C
PROBES REPORT 15:30
Insr. Probe : - 2.6°C
Room Probe : -23.6°C
PROBES REPORT 15:35
Insr. Probe : - 3.4°C
Room Probe : -25.6°C
PROBES REPORT 15:40
Insr. Probe : - 4.2°C
Room Probe : -28.6°C
    
```

### HOW to ORDER

XB500 X B 5 7 0 L - A B C D E **-17.8** For blue display please contact Dixell

A	B	C	D	E
<b>Power supply</b>	<b>Inputs</b>	<b>X-REP</b>	<b>Measurement unit</b>	<b>Printer output</b>
2 = 24Vac 4 = 110Vac 5 = 230Vac	N = NTC P = PTC	0 = No 1 = Yes	C = °C F = °F	0 = No 1 = Yes

**XB570L** | Blast chiller controller with four configurable cycles, RTC, printer output and serial output



L: 38x185mm

FEATURES	XB570L
First display: n° digits	± 3 d.p.
Second display: n° digits	± 4 d.p.
Power supply	24, 110, 230Vac
<b>Probe inputs</b>	
Thermostat	NTC, PTC
Defrost	NTC, PTC
Insert 1	NTC, PTC
Insert 2	NTC, PTC
Insert 3	NTC, PTC
<b>Digital inputs</b>	
Alarm	config
Door switch	pres
<b>Relay outputs</b>	
Compressor	20A
Defrost	8A
Fans	8A
Light	16A
AUX	8A
Alarm	16A
<b>Other</b>	
Hot Key 128/Prog Tool Kit output	pres
Remote display output	X-REP opt
Printer output	XB07PR opt
Serial output	RS485
Buzzer	pres
Real time clock	pres

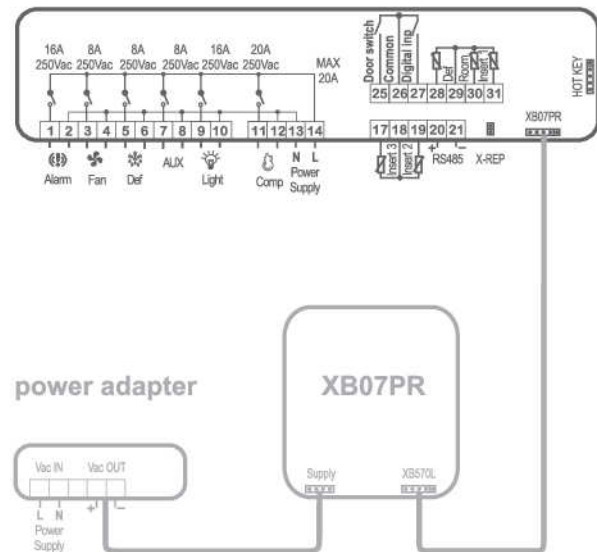

## HARD CHILL, SOFT CHILL, FREEZING, HOLDING

The XB570L has 4 different soft and hard chill cycles in its memory. These can also be modified by the User.

Each cycle is defined with independent time and temperature parameters to set each control phase and can be combined even with the hold phase. The four cycles are directly selectable from the keyboard. The control of each cycle is carried out using the insert probe or by time duration.

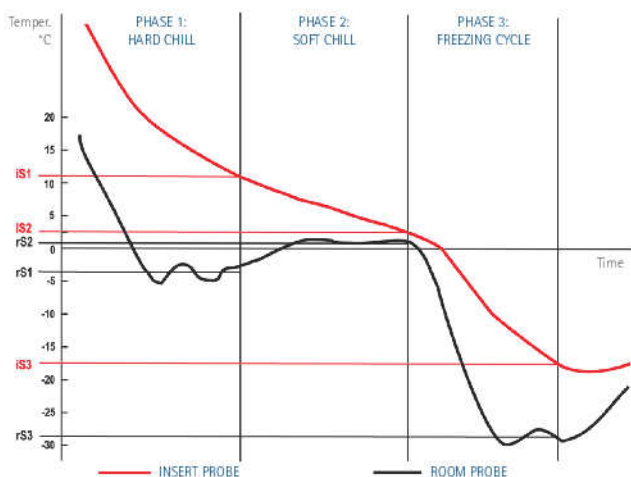



V: 100x64mm



100x64mm



K:0S/GS



L: 38x185mm



38x185mm

## XH200/300 SERIES: NT and LT REFRIGERATED and MATURING ROOM APPLICATIONS with TEMPERATURE/HUMIDITY MANAGEMENT

- Electronic controllers with temperature and humidity management
- Cooling and heating action for safe storage of products
- Defrost management
- Possibility of excluding humidity control
- Dehumidifying action by cooling circuit
- Running and stopping programmable cycles with different set points (XH300)
- Automatic cycles of extraction fans (XH300)
- Up to 8 push buttons with direct action for user friendly interface
- Direct line power supply 230 (110)Vac. No external transformer required
- Hot Key or Prog Tool Kit connector for quick and easy programming
- Serial connection to monitoring systems
- 10VA max power absorption
- Dual display with red LED (8,0mm high) and yellow LED (5,6mm high) and 14 icons

### HOW to ORDER

#### KEYBOARDS

	H	6	2	0	-	0	0	C	0	0
XH240K	X	H	2	4	0	K	-	A	0	0
XH	X	H		6	0		-	A	0	C



For inox version and blue display on T keyboards please contact Dixell



For inox version and blue display on L format please contact Dixell

A	C	D
<b>Power supply</b>	<b>Buzzer</b>	<b>Measurement unit</b>
2 = 24Vac	0 = No	C = °C - %RH
4 = 110Vac	1 = Yes	F = °F - %RH
5 = 230Vac		

ICON	MEANING
°C	Celsius degrees
°F	Fahrenheit degrees
❄️	Compressor
☀️	Heater control
(!)	Alarm
🌀	Fans
%RH	RH%
↑↑↑	Dehumidifying
↓↓↓	Humidifying
set	Temperature and humidity setting
📊	Running cycle (for XH300)
🕒	Cycle duration setting (for XH300)
💡	Light



### COMPLETE

The **dual display** and the **14 icons** show complete information about the status of the machine. Without the need to enter into the programming mode, all the main functioning of the cooling system are displayed with only one key touch.

### XH200: TEMPERATURE and HUMIDITY CONTROL

A neutral zone algorithm is used both for temperature and humidity. Instruments are provided with a compressor output (with defrost) and heating elements to control temperature.

Humidifier and dehumidifier (depending on model) outputs are provided for humidity. This assures both variables are kept inside the set band (neutral zone)

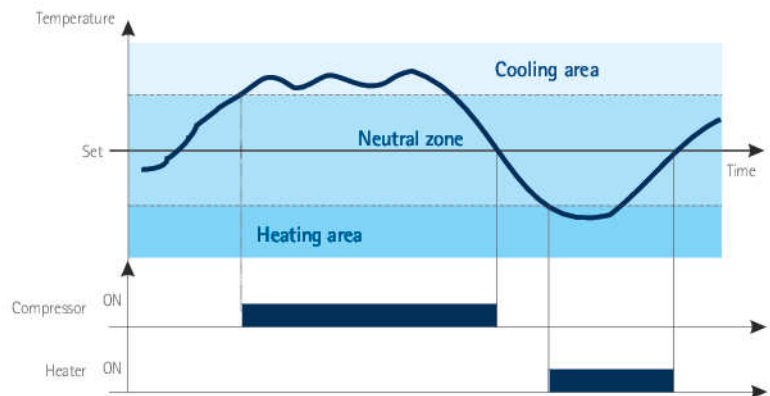

### XH300: EXAMPLE of MATURING CYCLE with RUNNING and STOPPING PHASE

T1: pre-cycle only with temperature control

T2: cycle with temperature and humidity control

T3: stopping phase

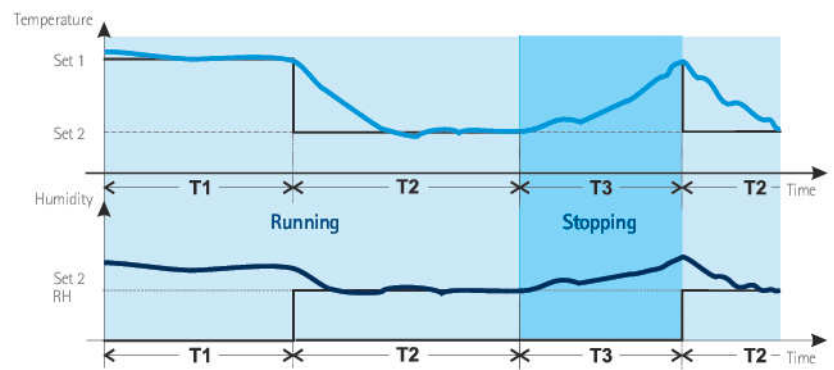

# XH200

## CONTROLLER and KEYBOARDS for NT and LT REFRIGERATED ROOMS with TEMPERATURE HUMIDITY MANAGEMENT



K: OS/GS

38x185mm

100x64mm

**XH240K** | Digital controller for NT and LT refrigerated rooms

**TH620** | Keyboard (horizontal WING) for XH240K controller

**VH620** | Keyboard (vertical WING) for XH240K controller

FEATURES	XH240K	TH620	VH620
<b>First display: n° digits</b>	on keyboard ± 3 d.p.	± 3 d.p.	± 3 d.p.
<b>Second display: n° digits</b>	on keyboard ± 4 d.p.	± 4 d.p.	± 4 d.p.
<b>Keyboard: push buttons</b>	6 (on TH620, VH620)	6	6
<b>Power supply</b>	24, 110, 230Vac	from controller	from controller
<b>Probe inputs</b>			
Thermostat	NTC		
Defrost			
Humidity	4÷20mA		
<b>Digital inputs</b>			
Heater safety, door switch	config		
<b>Relay outputs</b>			
Compressor	20A		
Defrost			
Defrost, extractor fans			
Fans	8A		
Heater control	16A		
Humidifying	8A		
Dehumidifying, light			
<b>Other</b>			
Hot Key/Prog Tool Kit output	pres		
Serial output	TTL		
Buzzer	on keyboard	opt	opt

### XH240K

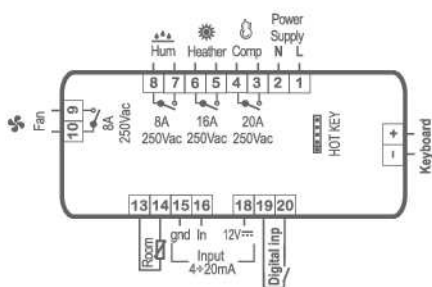

### The POWER MODULE in K FORMAT is AVAILABLE in 2 DIFFERENT VERSIONS

**OS:** open board

**GS:** standard plastic housing 190x140x70mm

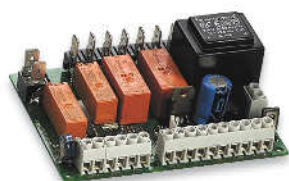

# CONTROLLERS for NT and LT REFRIGERATED and MATURING ROOMS with TEMPERATURE HUMIDITY MANAGEMENT

# XH200/300

**XH260L**  
**XH260V**

Digital controllers for NT and LT refrigerated rooms with defrost management

**XH360L**  
**XH360V**

Digital controllers for maturing rooms with running and stopping cycles, timed cycles, cooling and heating action and defrost



L: 38x185mm

V: 100x64mm

FEATURES	XH260L	XH260V	XH360L	XH360V
First display: n° digits	± 3 d.p.	± 3 d.p.	± 3 d.p.	± 3 d.p.
Second display: n° digits	± 4 d.p.	± 4 d.p.	± 4 d.p.	± 4 d.p.
Keyboard: push buttons	6	6	8	8
Power supply	24, 110, 230Vac	24, 110, 230Vac	24, 110, 230Vac	24, 110, 230Vac
<b>Probe inputs</b>				
Thermostat	NTC	NTC	NTC	NTC
Defrost	NTC	NTC	NTC	NTC
Humidity	4±20mA	4±20mA	4±20mA	4±20mA
<b>Digital inputs</b>				
Heater safety, door switch	config	config	config	config
<b>Relay outputs</b>				
Compressor	20A	8A	20A	8A
Defrost	8A	8A		
Defrost, extractor fans			8A	8A
Fans	8A	8A	8A	8A
Heater control	8A	8A	8A	8A
Humidifying	8A	8A	8A	8A
Dehumidifying, light	8A	8A	8A	8A
<b>Other</b>				
Hot Key/Prog Tool Kit output	pres	pres	pres	pres
Serial output	TTL	TTL	TTL	TTL
Buzzer	opt	opt	opt	opt

## XH260L

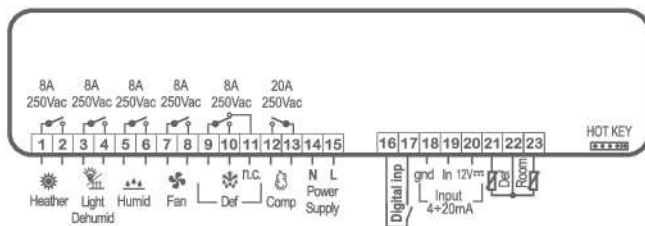

## XH260V

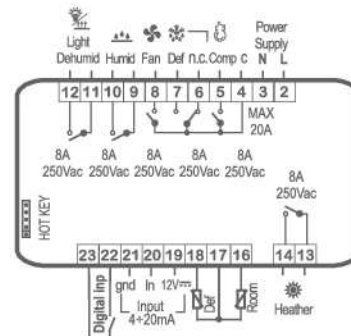

## XH360L

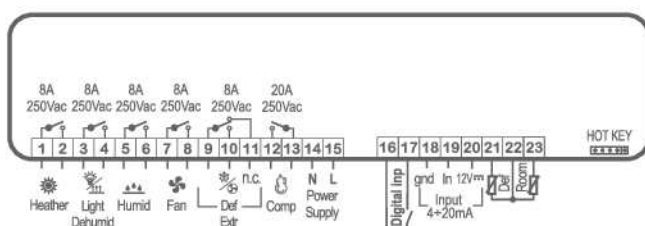

## XH360V

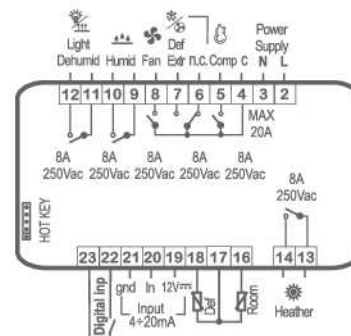



C: 32x74mm

## XR400 SERIES: NT and LT APPLICATIONS with DUAL TEMPERATURE MANAGEMENT

- Advanced multifunction refrigeration controllers with dual temperature management
- Ideal for heating-cooling applications such as bain-marie with under-counter refrigerated storage
- Designed for a dual refrigeration circuit or 2 independent circuits
- Integrated defrost management
- Cooling or heating action settable by user
- Instant visibility of machine status via display icons
- Hot Key or Prog Tool Kit connector for quick and easy programming
- Serial connection to monitoring systems
- 4VA max power absorption
- Dual display with red LED (8,0mm high) and yellow LED (5,6mm high) and 14 icons

### TYPICAL APPLICATIONS

1 circuit – 2 evaporators

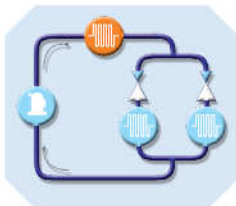

2 independent circuits

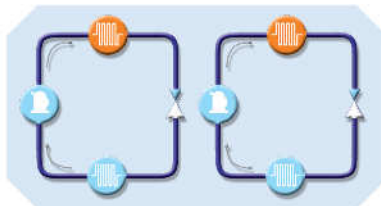

Heating and cooling application

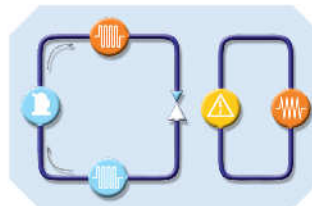

2 heating applications

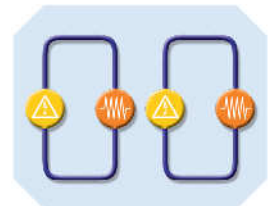

### HOW to ORDER

XR400 X R 4 0 C - A B C D O

A	B	C	D
<b>Power supply</b>	<b>Buzzer</b>	<b>RTC</b>	<b>Measurement unit</b>
0 = 12Vac/dc 1 = 24Vac/dc 2 = 24Vac 4 = 110Vac 5 = 230Vac	0 = No 1 = Yes	0 = No 1 = Yes	C = °C F = °F



# CONTROLLERS for STATIC or VENTILATED APPLICATIONS with DUAL TEMPERATURE MANAGEMENT

# XR400

**XR420C** | Digital controller for NT static applications with "off cycle" defrost

**XR460C** | Digital controller for NT and LT for ventilated applications



C: 32x74mm

FEATURES	XR420C	XR460C
First display: n° digits	± 3 d.p.	± 3 d.p.
Second display: n° digits	± 4 d.p.	± 4 d.p.
Power supply	24, 110, 230Vac	12, 24Vac/dc
<b>Probe inputs</b>		
Thermostat	NTC/PTC	NTC/PTC
Thermostat 2	NTC/PTC	NTC/PTC
Defrost	NTC/PTC	NTC/PTC
<b>Digital inputs</b>		
Safety, start defrost, door switch	config	2 x config
<b>Relay outputs</b>		
Compressor	8A	8A
Compressor 2	8A	8A
Defrost		8A
Fans		8A
Light	8A	
<b>Other</b>		
Hot Key/Prog Tool Kit output	pres	pres
Serial output	TTL	TTL
Buzzer	opt	opt
Real time clock	opt	opt

**XR420C**

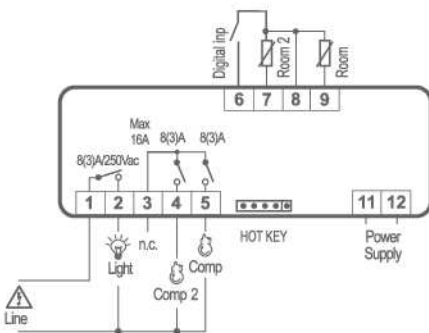

**XR460C**

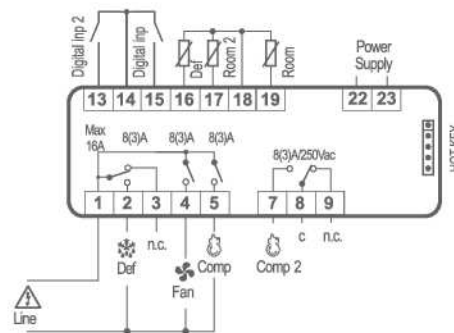



C: 32x74mm



## XR700: NT and LT APPLICATIONS with HACCP FUNCTION

- Digital controller with HACCP function
- Monitoring, signalling and recording of the critical temperature
- Real time display of the peaks and their duration
- Correct storage of products
- Hot Key or Prog Tool Kit connector for quick and easy programming
- Serial connection to monitoring systems
- 4VA max power absorption
- Dual display with red LED (8,0mm high) and yellow LED (5,6mm high) and 13 icons

### COMPLETE

The **dual display** with **13 icons** shows complete information about the status of the machine. Without the need to enter into the programming mode, all the main functioning of the cooling system is displayed with only one key touch.



### HOW to ORDER

XR700C X R 7 7 5 C - A 0 0 D E

A	D	E
<b>Power supply</b>	<b>Measurement unit</b>	<b>RS485 output</b>
0 = 12Vac/dc	C = °C	0 = No
1 = 24Vac/dc	F = °F	1 = Yes

# CONTROLLER with HACCP FUNCTION for VENTILATED APPLICATIONS

# XR700

XR775C | Digital controller for NT and LT ventilated applications



C: 32x74mm

FEATURES	XR775C
First display: n° digits	± 3 d.p.
Second display: n° digits	± 4 d.p.
Power supply	12, 24Vac/dc
<b>Probe inputs</b>	
Thermostat	NTC
Defrost	NTC
Display	NTC
<b>Digital inputs</b>	
Alarm, door switch, light, defrost	config
Door switch	pres
<b>Relay outputs</b>	
Compressor	8A
Defrost	8A
Fans	8A
Light, alarm	8A config
<b>Other</b>	
Hot Key/Prog Tool Kit output	pres
Serial output	TTL, RS485 opt
Buzzer	pres
Real time clock	pres

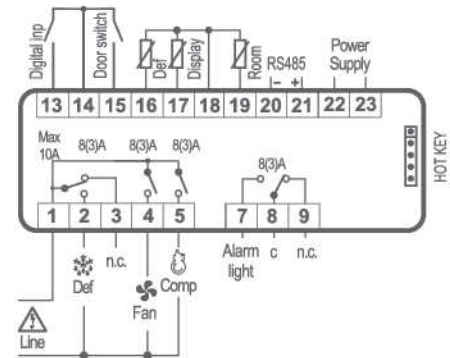

## EXAMPLE of HIGH TEMPERATURE ALARM

When a high (or low) temperature alarm occurs, instrument records the start ① and end time ②, the date and the maximum (or minimum) temperature ③ reached.

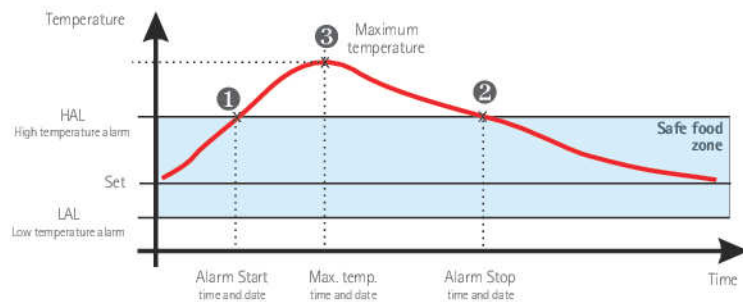

## BLACKOUT ALARM

If, after a blackout, the temperature is higher than the alarm value, the start of the blackout ① and the end of alarm temperature ② together with the max temperature reached ③ are recorded.

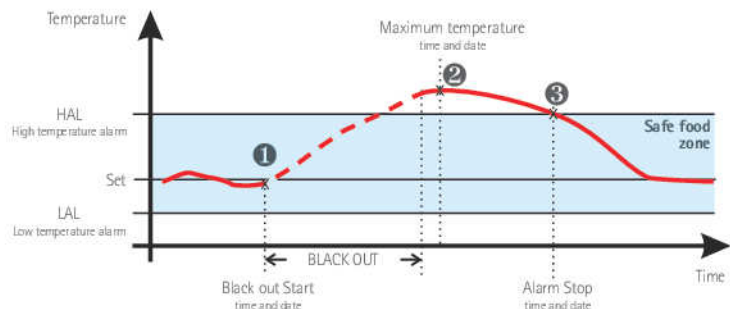



## XDL: TEMPERATURE and STATUS RECORDING

- Temperature and status recording module for refrigerating applications that works in accordance to HACCP rules
- Connection to Dixell instruments equipped with the serial output or combined with the XJDL40D probe module
- Monitoring of temperature (up to 4), alarms and digital inputs is simple and intuitive
- Stand-alone operation in a 4 DIN module XJDL40D
- Fast and simple mounting
- Recorded data download on a USB driver: txt format that can also be displayed in EXCEL®
- Data recording: up to 1 year with sampling up to 16 minutes (settable)
- TTL and RS485 inputs with internal converter (on PW-DL power supply or XJDL40D)
- Temperature recording kit available on request with minimum quantity 20 pieces
- 5VA max power absorption
- Dual display with red LED (8,0mm high) and yellow LED (5,6mm high) and 17 icons

DATE	PB1	PB2	PB3	PB4	STATUS
19/09/2012 11.34	-18.4	-25.8	---	---	ON/C
19/09/2012 11.39	-17.8	-25.8	---	---	ON/C
19/09/2012 11.54	-18.0	-25.6	---	---	ON/C
19/09/2012 12.02	---	---	---	---	OFF
19/09/2012 12.14	-18.5	-24.8	---	---	ON/C
19/09/2012 12.24	-17.7	-25.2	---	---	ON/C

### HOW to ORDER

XDL01	X	D	L	0	1	-	0	0	0	D	0								
XJDL40D	X	J	D	L	4	0	D	-	A	B	0	D	0						
PW-KIT	X	D	L	0	1	-	P	W	-	K	I	T	-	A	0	0	D	0	
XJ-KIT	X	D	L	0	1	-	X	J	-	K	I	T	-	A	0	0	D	0	
XJB-KIT	X	D	L	0	1	-	X	J	B	-	K	I	T	-	A	0	0	D	0

A	B	D
<b>Power supply</b>	<b>Battery output</b>	<b>Measurement unit</b>
2 = 24Vac	0 = No	0 = °C decimal
3 = 9±40Vdc	1 = Yes (not available with power supply 9±40Vdc)	1 = °C integer
5 = 230Vac		2 = °F

- XDL01** Temperature and status recording module (with cable CAB/RS1, 1m included) that works with Dixell instruments equipped with the serial output (via PW-DL) or combined with the XJDL40D probe module
- XJDL40D** Probe and status acquisition module for XDL01 with external battery input and female connector included



45x70mm



D: 4 DIN Rail

## TEMPERATURE RECORDING KIT

### XDL01-PW-KIT

Kit composed of XDL01, PW-DL and XDL-KEY

### XDL01-XJ-KIT

Kit composed of: XDL01, XJDL40D, XDL-KEY and 2 NG6 probes, 3m

### XDL01-XJB-KIT

Kit composed of: XDL01, XJDL40D, BA6H, XDL-KEY and 2 NG6 probes, 3m

FEATURES	XDL01	XJDL40D
First display: n° digits	± 3 d.p.	
Second display: n° digits	± 4 d.p.	
Power supply	from PW-DL o XJDL40D	24, 230Vac, 9÷40Vdc
<b>Probe inputs</b>		
Temperature 1		NTC/Pt1000
Temperature 2		NTC/Pt1000
Temperature 3		NTC/Pt1000
Temperature 4		NTC/Pt1000/4÷20mA
<b>Digital inputs</b>		
External alarm, defrost		4 x config
<b>Relay outputs</b>		
Alarm		8A
<b>Other</b>		
Hot Key/Prog Tool Kit output		pres
USB output	pres	
Serial output	TTL	TTL
Battery backup	internal 48h	external (6 or 24h) opt
Real time clock	pres	

### XDL01 - PW-DL

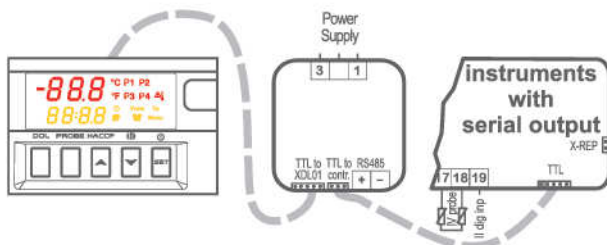

The XDL01 data recording module is connected to the PW-DL power supply and is also an interface with Dixell instruments with TTL or RS485 serial output

### XDL01 - XJDL40D

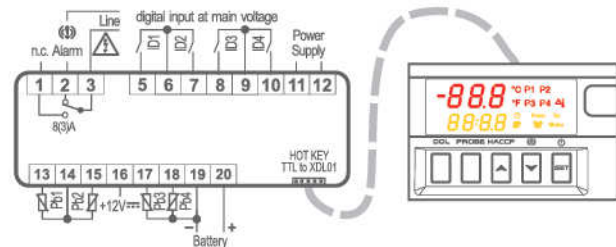

The XDL01 data recording module is directly connected to the XJDL40D probe module

## ACCESSORIES



### PW-DL

Power supplier (24, 230Vac) for XDL01 module (with CAB/DL2 cable, 2m included) works as a gateway between the XDL01 and Dixell instruments equipped with TTL or RS485 serial output  
How to order: PW-DL-20000 (for 24Vac)  
PW-DL-50000 (for 230Vac)



### BA6H

Battery for XJDL40D of 1.2Ah, 6 hours of backup



### XDL-KEY

USB pendrive for XDL01



### BA24H

Battery for XJDL40D of 4.0Ah, 24 hours of backup



## XW700 SERIES: PHARMACEUTICAL APPLICATIONS

- Digital controllers for pharmaceutical cabinets
- Also ideal for applications up to -100°C
- Temperature, alarms and load status recording
- LCD graphic interface (or Touch Screen on request) with panel or wall mounting
- Last 24 hours temperature graphic display
- Battery backup in case of power supply failure
- Data download on USB pendrive: txt format compatible with EXCEL®
- Data recording: up to 1 year with sampling every 15 minutes
- Programmable sampling time from 3 to 60 minutes
- Hot Key or Prog Tool Kit connector for quick and easy programming
- Serial connection to monitoring systems
- 10VA max power absorption

### HOW to ORDER

XW700 X W 7 7 K - A B 0 D 0

A	B	D
<b>Power supply</b>	<b>Inputs</b>	<b>Light relay</b>
4 = 110Vac	N = NTC	16A
5 = 230Vac	L = NTC	16A neon
	S = Pt1000	16A
	T = Pt1000	16A neon
		<b>Measurement unit</b>
		C = °C
		F = °F

VGW870 V G W 8 7 0 - 1 B 0 0 0



For TOUCH SCREEN interface please contact Dixell  
More information on TGIPG family on page 118.

B

#### Kind of mounting

P = Panel

W = Wall

# CONTROLLERS and GRAPHIC DISPLAY for VENTILATED PHARMACEUTICAL APPLICATIONS

# XW700

<b>XW737K</b>	Digital controller for ventilated pharmaceutical applications
<b>XW777K</b>	Digital controller for ventilated pharmaceutical applications with defrost and auxiliary relay management
<b>VGW870</b>	Remote keyboard with LCD graphic display and dedicated interface for medical applications for XW700 controllers (IP65 front protection)



K: 8 DIN Rail



VG: 82x156mm

FEATURES	XW737K	XW777K	VGW870
<b>Display</b>	LCD on VGW870	LCD on VGW870	LCD - 240x96pixels
<b>Power supply</b>	110, 230Vac	110, 230Vac	from controller
<b>Probe inputs</b>			
Thermostat	NTC, Pt1000	NTC, Pt1000	
Defrost	NTC, Pt1000	NTC, Pt1000	
Product 1	NTC, Pt1000	NTC, Pt1000	
Product 2	NTC, Pt1000	NTC, Pt1000	
<b>Digital inputs</b>			
Alarm, start defrost, door switch, pressure switch	2 x config	2 x config	
<b>Relay outputs</b>			
Compressor	20A	20A	
Defrost		8A	
Fans	8A	8A	
Light	16A	16A	
Alarm	8A	8A	
AUX		8A	
<b>Other</b>			
Hot Key/Prog Tool Kit output	pres	pres	
Visokey output			pres
USB output	pres	pres	
Serial output	TTL	TTL	
Buzzer	on keyboard	on keyboard	pres
Real time clock	with battery	with battery	
Backup battery input	pres	pres	

## XW737K

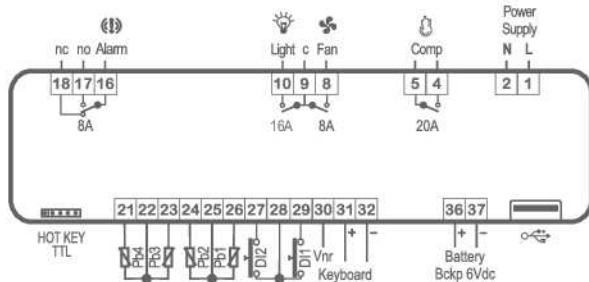

## XW777K

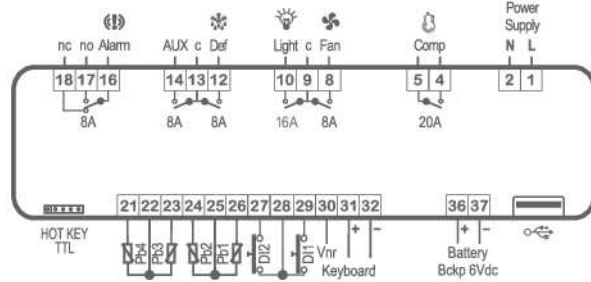

## ACCESSORIES



**XDL-KEY**  
USB pendrive for XW700 controllers



**CAB-USB10**  
USB extended cable, 1m with plastic cap



38x185mm



L: 38x185mm

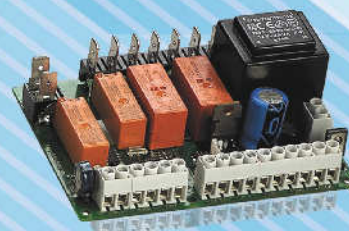

K: 0S/GS



CX: 32x74mm

## XR20/60 & XW20/60/300: NT and LT REFRIGERATED TRUCKS APPLICATIONS

- Digital controllers designed for refrigerated trucks (9÷40Vdc power supply)
- Maximum and minimum temperature recording/visualisation
- Possibility of controlling one LT and one NT compartment or one refrigerated and one heated compartment (XW300)
- "On demand" defrost for optimum defrost cycles management (XW300)
- Service hours count for system maintenance cycles (XW300)
- Thermostatic command for shutter opening (XW300)
- Hot Key or Prog Tool Kit connector for quick and easy programming
- Serial connection to monitoring systems
- 3VA max power absorption (10VA max for XW300)
- Display with red LED, 13,2mm high (red LED, 10,5mm high and icons for CX format)

### HOW to ORDER

XR20/60 X R O C X - 3 B C D E  For blue display please contact Dixell

B	C	D	E
<b>Inputs</b> N = NTC P = PTC	<b>Buzzer</b> 0 = No 1 = Yes 2 = No 3 = Yes	<b>X-REP output (excludes TTL output)</b> No No Yes Yes	<b>Measurement unit</b> C = °C F = °F
			<b>Connections</b> 0 = Screw 6 = Faston

XW20/60 X W L - 3 B C D O  For blue display please contact Dixell

B	C	D
<b>Inputs</b> N = NTC P = PTC	<b>Buzzer</b> 0 = No 1 = Yes	<b>Measurement unit</b> C = °C F = °F

KEYBOARD T 6 3 0 - A 0 0 D O  For blue display please contact Dixell

XW300 X W 3 O K - 3 N C D E

A	C	D	E
<b>Buzzer</b> 0 = No 1 = Yes	<b>Housing</b> 0 = Open board "OS" 2 = "GS" housing 182x142x76mm 4 = "GS" housing 225x180x84mm	<b>Measurement unit</b> C = °C F = °F	<b>Built-in RS485</b> 0 = No 2 = No 4 = Yes 6 = Yes
			<b>4÷20mA</b> No Yes No Yes



# CONTROLLERS for STATIC and VENTILATED APPLICATIONS on REFRIGERATED TRUCKS

# XR20/60 & XW20/60

**XR20CX  
XW20L**

Digital controllers for NT static applications with "off cycle" defrost



CX: 32x74mm



L: 38x185mm

**XR60CX  
XW60L**

Digital controllers for NT and LT ventilated applications with defrost management

FEATURES	XR20CX	XW20L	XR60CX	XW60L
Display: n° digits	± 3 d.p.	± 3 d.p.	± 3 d.p.	± 3 d.p.
Power supply	9±40Vdc	9±40Vdc	9±40Vdc	9±40Vdc
<b>Probe inputs</b>				
Thermostat	NTC, PTC	NTC, PTC	NTC, PTC	NTC, PTC
Defrost			NTC, PTC	NTC, PTC
Condenser	NTC, PTC on HOT KEY		NTC, PTC on HOT KEY	
<b>Digital inputs</b>				
Alarm, start defrost, door switch, pressure switch	config	config	config	config
<b>Relay outputs</b>				
Compressor	8A	8A	8A	8A
Defrost			8A	8A
Fans			8A	8A
Light		8A		8A
<b>Other</b>				
Hot Key/Prog Tool Kit output	pres	pres	pres	pres
Remote display output	X-REP opt		X-REP opt	
Serial output	TTL		TTL	
Buzzer	opt	opt	opt	opt

## XR20CX

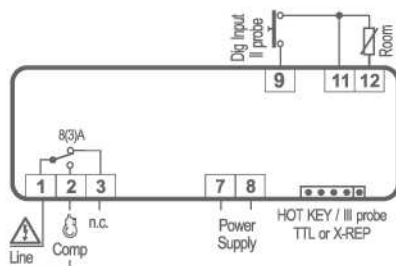

## XW20L

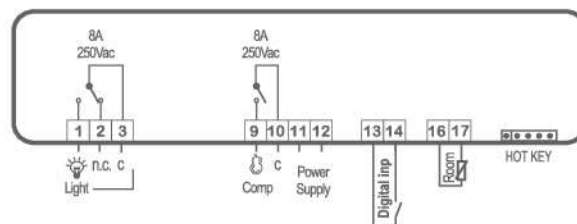

## XR60CX

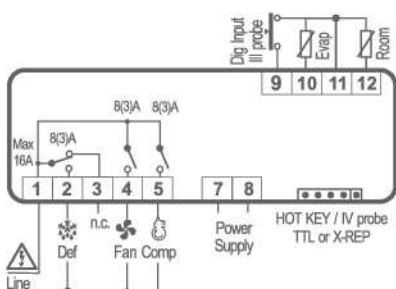

## XW60L

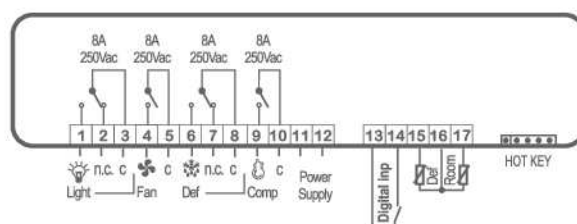

# XW300

## CONTROLLERS and KEYBOARD for VENTILATED APPLICATIONS with "on DEMAND" DEFROST on REFRIGERATED TRUCKS



K: OS/GS



38x185mm

<b>XW360K</b>	Digital controller with NT and LT ventilated applications with "on demand" defrost
<b>XW370K</b>	Digital controller with NT and LT ventilated applications with "on demand" defrost, heater and shutter management
<b>T630</b>	Keyboard for XW300 controllers

FEATURES	XW360K	XW370K	T630
<b>Display: n° digits</b>	on keyboard ± 3 d.p.	on keyboard ± 3 d.p.	± 3 d.p.
<b>Power supply</b>	9±40Vdc	9±40Vdc	from controller
<b>Probe inputs</b>			
Thermostat	NTC	NTC	
NT thermostat		NTC	
Defrost	NTC	NTC	
"on demand" defrost	NTC	NTC	
<b>Digital inputs</b>			
Generic alarm, block alarm, pressure switch, start defrost, change working mode, heater output	config	config	
Door switch	pres	pres	
<b>Relay outputs</b>			
Compressor	8A	8A	
Defrost	8A	8A	
Fans	8A	8A	
Heater control		8A	
Light	8A	8A	
Shutter		8A	
<b>Other</b>			
Hot Key/Prog Tool Kit output	pres	pres	
Serial output	RS485 opt	RS485 opt	
Analog output	4÷20mA opt	4÷20mA opt	
Buzzer	on keyboard	on keyboard	opt

**XW360K**

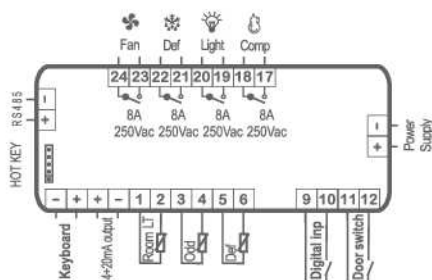

**XW370K**

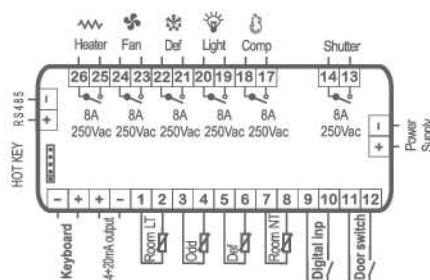

### The POWER MODULES in K FORMAT are AVAILABLE in 2 DIFFERENT VERSIONS

**OS:** open board

**GS:** with plastic housing 182x142x76mm or 225x180x84mm

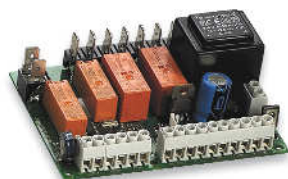



# COMPRESSOR RACK REFRIGERATION CONTROLLERS

## SECTION INDEX

FUNCTIONS	MODELS	
<b>XEV02 – Digital™ compressor applications</b>		<b>76</b>
Driver slave for Digital™ compressor management	XEV02D	77
<b>XC10/30 – condensing unit applications</b>		<b>78</b>
Condensing unit controller	XC10CX	79
Condensing unit controller with fans management	XC30CX	79
Accessory	CAB/HK	79
<b>XC400/600 – up to 6 compressor/fan output applications also with inverter management</b>		<b>80</b>
Controller for managing up to 4 compressors/fans	XC640D	82
Controllers for managing up to 5 compressors/fans	XC450CX – XC650CX – XC652CX	82
Controllers with Digital™ compressor management	XC645CX – XC645D	82
Controller for managing up to 6 compressors/fans	XC660D	83
Keyboard for controllers in D format	VC660	83
<b>XC1000 – up to 15 compressor/fan output applications</b>		<b>84</b>
Controller for simultaneous management of up to 8 compressors and fans	XC1008D	88
Controller for simultaneous management of up to 11 compressors and fans	XC1011D	88
Controller for simultaneous management of up to 15 compressors and fans	XC1015D	89
Graphic display for XC1000 controllers	VGC810	89
<b>iProRACK – up to 2 circuit and 6 compressor per circuit applications</b>		<b>90</b>
Controllers for management of up to 2 circuits and 6 compressors per circuit	IPR208D – IPR215D	92
Graphic display for iProRACK controllers	VGIPG	92



D: 4 DIN Rail

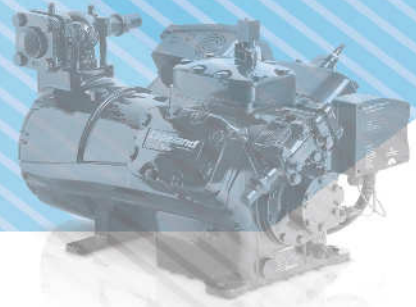

## XEVO2: DIGITAL™ COMPRESSOR APPLICATIONS

- Driver slave for Digital™ compressor management
- Compatible with XC400/600, XC1000 and iProRACK controllers
- Optimal management of "Demand Cooling" applications
- Last 10 alarms recording (kind, duration)
- Temperature analog inputs (NTC86K, Pt1000)
- Pressure analog inputs (0÷5V, 4÷20mA)
- Alarm management (visual or through digital output)
- Digital inputs (1 insulated, 1 voltage)
- Hot Key or Prog Tool Kit connector for quick and easy programming
- Serial connection to monitoring systems
- 6VA max power absorption
- Display with red LED (10,5mm high) and icons

### HOW to ORDER

XEVO2D X E V O 2 D - A B C D O

A	B	C	D
<b>Power supply</b>	<b>Temperature probe</b>	<b>Pressure probe</b>	<b>Measurement unit</b>
2 = 24Vac	N = NTC86K	0 = No	B = Bar/°C
4 = 110Vac	P = Pt1000	1 = 0÷5V	P = PSI/°F
5 = 230Vac		2 = 4÷20mA	H = KPA/°C
		3 = PP11	
		4 = PP30	
		5 = PPR15	
		6 = PPR30	

XEV02D | Driver slave for Digital™ compressor management with triac and open collector outputs



D: 4 DIN Rail

FEATURES	XEV02D
Display: n° digits	± 3 d.p.
Keyboard: push buttons	4
Power supply	24, 110, 230Vac
<b>Probe inputs</b>	
Suction pressure	4±20mA, 0÷5V
Discharge line temperature (DLT)	NTC86K, Pt1000
<b>Digital inputs</b>	
Free of voltage	pres
High voltage	pres
<b>Relay outputs</b>	
Alarm	8A config
<b>Other</b>	
Triac output	pres
Open collector output	config
Hot Key/Prog Tool Kit output	pres
Serial output	RS485
Buzzer	pres

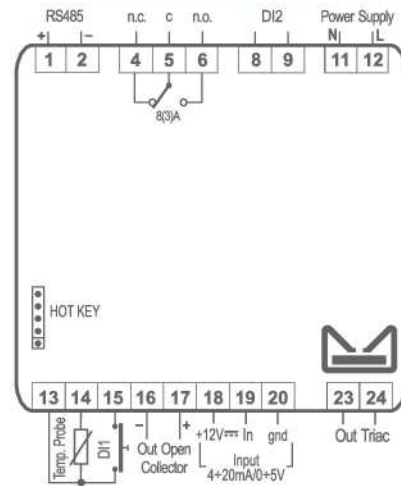

## COMPATIBILITY with DIXELL CONTROLLERS

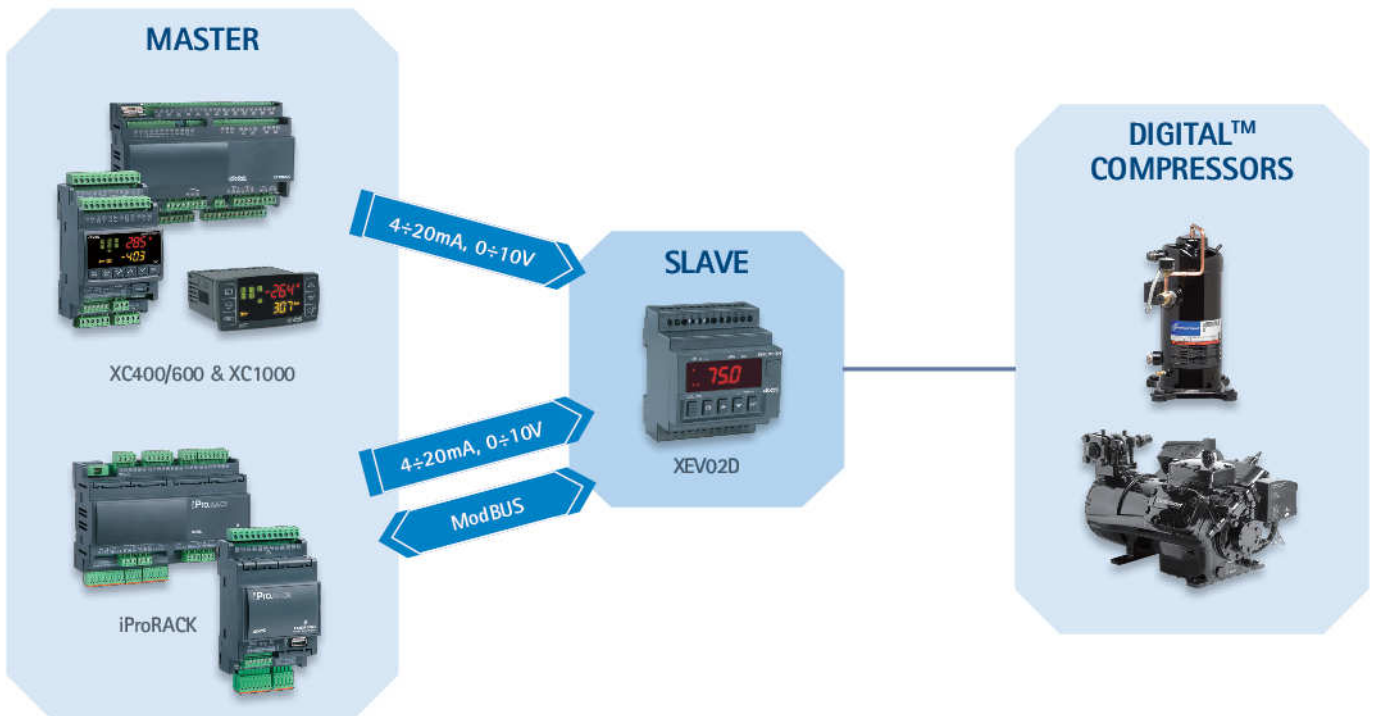



CX: 32x74mm



## XC10/30 SERIES: CONDENSING UNIT APPLICATIONS

- Electronic controllers for condensing unit management with alarm log
- Smart error pressure probe management
- External trigger signal to enable regulation (fig. 1)
- Flooded start protection
- Suction and discharging lines temperature control
- Compressor working time and activation counters
- Safety control of high pressure and high condensing/suction temperature
- Fan cycling management to share the working load
- Direct access to alarm menu, working time and load activation
- Management of 1 compressor and up to 2 fans (XC30CX)
- Hot Key or Prog Tool Kit connector for quick and easy programming
- 3VA max power absorption
- Display with red LED (10,5mm high) and icons

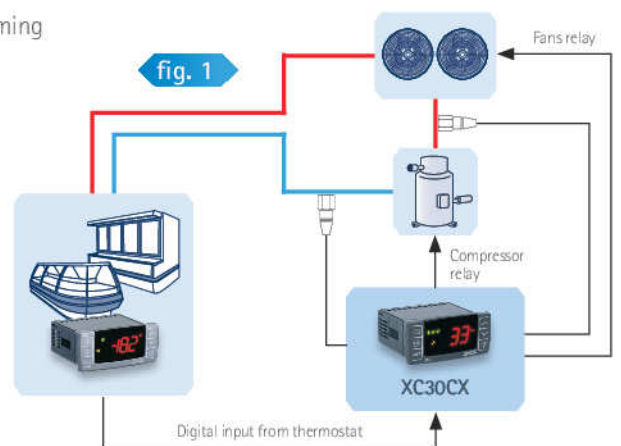

### HOW to ORDER

XC10/30 X C O C X - A B C O E

A	B	C	E
<b>Power supply</b>	<b>Measurement unit</b>	<b>Buzzer</b>	<b>Input</b>
4 = 110Vac 5 = 230Vac	B = Bar/°C P = PSI/°F H = KPA/°C	0 = No 1 = Yes	G = 0÷5V (suction)/NTC (condensing) H = 0÷5V (suction)/0÷5V (condensing)

- XC10CX** | Condensing unit controller with 1 compressor
- XC30CX** | Condensing unit controller with 1 compressor and 2 fans



CX: 32x74mm

FEATURES	XC10CX	XC30CX
Display: n° digits	± 3 d.p.	± 3 d.p.
Power supply	110, 230Vac	110, 230Vac
<b>Probe inputs</b>		
Suction pressure	0÷5V	0÷5V
Condensing pressure	0÷5V, NTC	0÷5V, NTC
Discharge temperature	PTC	PTC
<b>Digital inputs</b>		
High pressure safety	pres	pres
Thermostat	pres	pres
<b>Relay outputs</b>		
Compressor	20A	20A
Fans		8A
Fans 2		5A
<b>Other</b>		
Hot Key/Prog Tool Kit output	pres	pres
Buzzer	opt	opt

## XC10CX

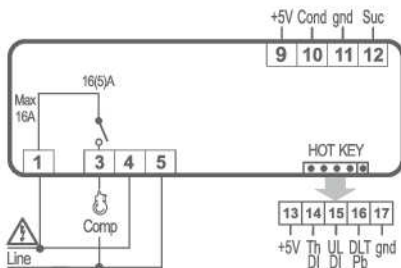

## XC30CX

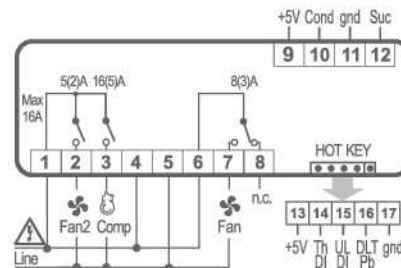

## FAN MANAGEMENT

XC30CX has 2 outputs to drive 2 different condensing fans. A smart fan algorithm shares the fan working time between the outputs

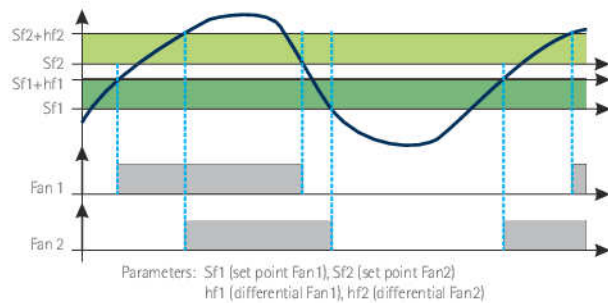

## ACCESSORY

### CAB/HK

Adapter cable, 5 pins for Hot Key input, 0,5m





D: 4 DIN Rail



CX: 32x74mm



100x64mm

## XC400/600 SERIES: up to 6 COMPRESSOR/FAN OUTPUT APPLICATIONS also with INVERTER MANAGEMENT

- Electronic controllers for compact compressor racks management also with inverter
- Compressor types: Digital™, multi-stages, differing power, semi-hermetic, scroll and screw
- Proportional band or neutral zone control
- Floating condensing pressure control depending on the external temperature
- High configurability and flexibility
- Automatic switch-off of the compressors in case of high condensing pressure/temperature
- Silent mode function for fans during the night
- Correct lubrication automatic restore cycle
- Safer control with low pressure electronic pressure switch
- Type of gas setting: to control temperature or pressure
- Hot Key or Prog Tool Kit connector for quick and easy programming
- Serial connection to monitoring systems
- 5VA max power absorption
- Dual display with red LED (8,5mm high) and yellow LED (7,5mm high) and 17 icons

### HOW to ORDER

XC400/600CX	X	C			C	X	-	A	B	C	D	E
XC600D	X	6			D	-	A	B	1	D	E	
VC660	V	C	6	6	0	-	0	0	C	0	0	

A	B	C	D	E
<b>Power supply*</b>	<b>Measurement unit</b>	<b>Buzzer</b>	<b>TRIAC voltage**</b>	<b>Analog outputs</b>
0 = 12Vac/dc	C = °C	0 = No	0 = 110÷230Vac	No
1 = 24Vac/dc	F = °F	1 = Yes	1 = 110÷230Vac	Yes
4 = 110Vac	B = Bar		2 = 24Vac	No
5 = 230Vac	P = PSI		3 = 24Vac	Yes
	H = KPA		4 = No TRIAC	No
			5 = No TRIAC	Yes
				<b>Input</b>
				A = PP11 (only for XC450CX)
				B = PP30 (only for XC450CX)
				C = NTC
				E = 4÷20mA
				F = PP11 (suction)/PP30 (discharge)
				H = 0÷5V (ratiometric)

\* 0, 1 (only for XC400CX and XC600CX)  
4, 5 (only for XC600D)

\*\* 0, 1, 2, 3 (only for XC645)  
4, 5 (not for XC645)



## TYPE of COMPRESSOR RACKS

The XC400/600 series, thanks to a powerful and complete range, ensures optimal management of compact compressor racks:

- with compressors and fans also with suction or discharge inverter;
- with 2 discharge and 1 suction also with inverter;
- with Digital™ compressors.

XC645CX - XC645D  
APPROVED FOR



Example of circuits managed by the XC400/600 series

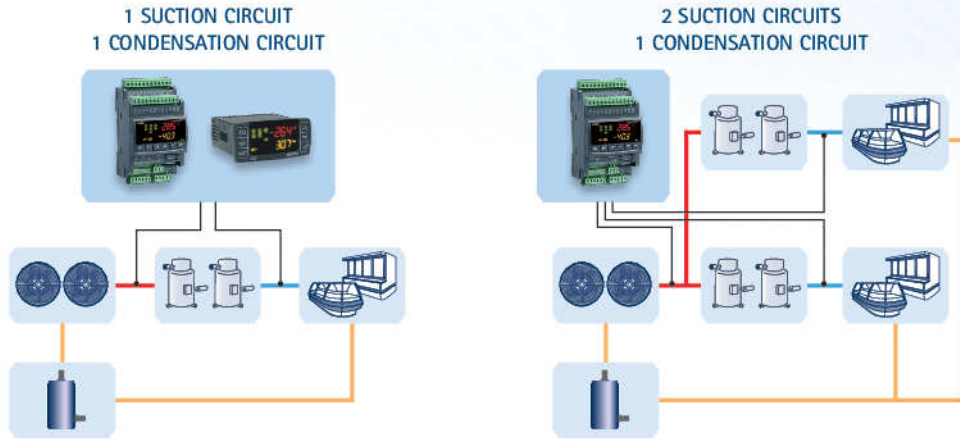

## CONNECTIONS

2 different version of terminal block are available depending on the model of the controllers:

Screws for XC400CX



Disconnectable for XC600CX



Screw disconnectable for XC600D



## FLOATING CONDENSING

The dynamic set point guarantees excellent plant efficiency, taking real operational conditions into consideration. The condensing set point is automatically adjusted according to the external temperature, keeping the safety values, to optimize the condensing temperature. The reduction of this temperature entails a reduction of the pressure gap between suction and condensing decreasing the consumption of compressors and saving energy.

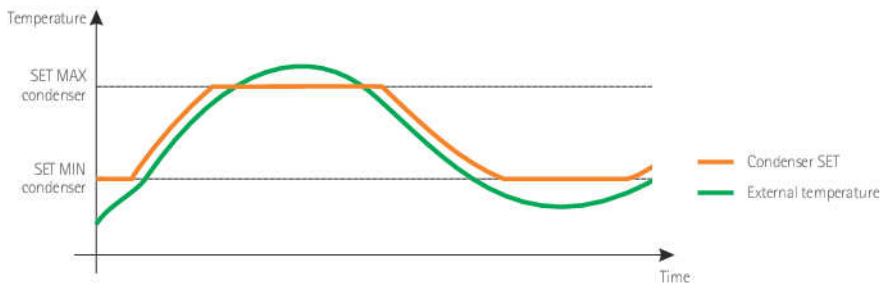

## FAN FUNCTIONING DURING NIGHT MODE

This special function allows the maximum fan speed to be decreased, which reduces plant noise. Thanks to the **MES** (Maximum output during Energy Saving) the maximum fan speed is reduced during the night.

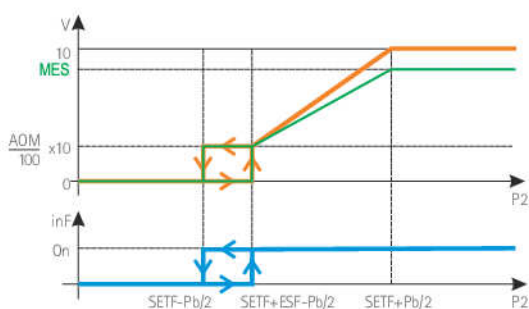

- SETF**: supply pressure setting to be maintained
- Pb/2**: regulation band centred around the setting
- AOM**: minimum allowed speed for the fans
- inF**: relay set as fan inverter
- P2**: condensing pressure (temperature) probe
- V**: analogical output value set as 0÷10V
- ESF**: energy saving differential for fan regulation

# XC400/600

## Up to 5 COMPRESSOR/FAN COMPRESSOR RACK CONTROLLERS also with INVERTER MANAGEMENT



CX: 32x74mm

D: 4 DIN Rail

**XC450CX** Digital controller for managing up to 5 compressors or fans

**XC640D** Digital controller for simultaneous management of up to 4 compressors and fans

**XC645CX**  
**XC645D** Digital controllers for Digital™ compressor management

FEATURES	XC450CX	XC640D	XC645CX	XC645D
<b>First display: n° digits</b>	± 4 d.p.	± 4 d.p.	± 4 d.p.	± 4 d.p.
<b>Second display: n° digits</b>	± 4 d.p.	± 4 d.p.	± 4 d.p.	± 4 d.p.
<b>Power supply</b>	12, 24Vac/dc	110, 230Vac	12, 24Vac/dc	110, 230Vac
<b>Probe inputs</b>				
Suction	0÷5V, 4÷20mA, NTC	0÷5V, 4÷20mA, NTC	0÷5V, 4÷20mA, NTC	0÷5V, 4÷20mA, NTC
Suction 2				
Condensing	0÷5V, 4÷20mA, NTC	0÷5V, 4÷20mA, NTC	0÷5V, 4÷20mA, NTC	0÷5V, 4÷20mA, NTC
Configurable		NTC	NTC	NTC
<b>Digital inputs</b>				
Low pressure switch		1	1	1
High pressure switch		1	1	1
Alarm	5	4	4	5
Configurables	1	2	1	2
<b>Relay outputs</b>				
Loads	5 x 5A	4 x 5A	4 x 5A	4 x 5A
<b>Other outputs</b>				
Digital™ compressor			TRIAC	TRIAC
Inverter-compressor		4÷20mA/0÷10V opt		4÷20mA/0÷10V opt
Inverter-fans		4÷20mA/0÷10V opt		4÷20mA/0÷10V opt
Load			4÷20mA/0÷10V opt	4÷20mA/0÷10V opt
Hot Key/Prog Tool Kit	pres	pres	12V/40mA	pres
Serial	TTL	RS485	TTL	RS485
<b>Other</b>				
Remote keyboard		VC660		VC660
Alarms	last 10	last 10	last 10	last 10
Buzzer	opt	pres	opt	pres
Connection kit			CWC15-KIT, CWC30-KIT, CAB/CJ15, CAB/CJ30	

### XC450CX

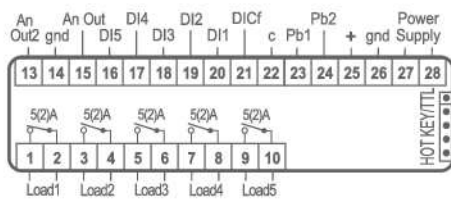

### XC645CX

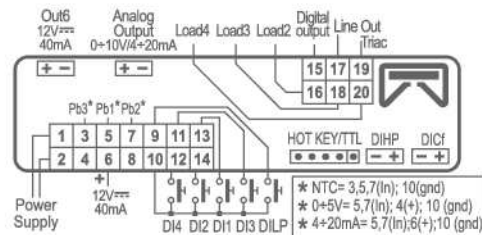

### XC640D

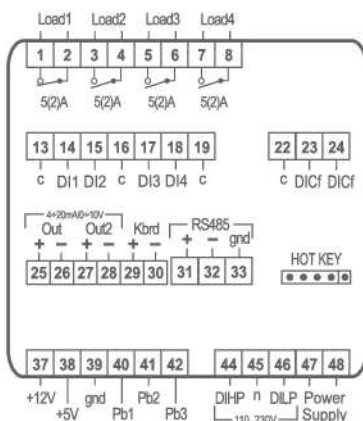

### XC645D

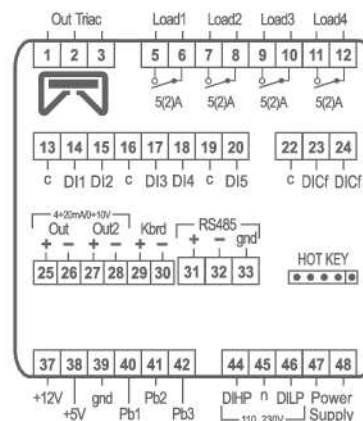

# Up to 6 COMPRESSOR/FAN COMPRESSOR RACK CONTROLLERS and KEYBOARD also with INVERTER MANAGEMENT

# XC600

<b>XC650CX</b>	Digital controller for simultaneous management of up to 5 compressors and fans
<b>XC652CX</b>	Compressor rack digital controller with 2 suction
<b>XC660D</b>	Digital controller for simultaneous management of up to 6 compressors and fans
<b>VC660</b>	Keyboard for XC660D controllers



CX: 32x74mm    D: 4 DIN Rail    100x64mm

FEATURES	XC650CX	XC652CX	XC660D	VC660
<b>First display: n° digits</b>	± 4 d.p.	± 4 d.p.	± 4 d.p.	± 4 d.p.
<b>Second display: n° digits</b>	± 4 d.p.	± 4 d.p.	± 4 d.p.	± 4 d.p.
<b>Power supply</b>	12, 24Vac/dc	12, 24Vac/dc	110, 230Vac	from controller
<b>Probe inputs</b>				
Suction	0÷5V, 4÷20mA, NTC	0÷5V, 4÷20mA, NTC	0÷5V, 4÷20mA, NTC	
Suction 2		0÷5V, 4÷20mA, NTC		
Condensing	0÷5V, 4÷20mA, NTC	NTC	0÷5V, 4÷20mA, NTC	
Configurable	NTC		0÷5V, 4÷20mA, NTC	
<b>Digital inputs</b>				
Low pressure switch	1	1	1	
High pressure switch	1	1	1	
Alarm	4	4	6	
Configurables	1	1	2	
<b>Relay outputs</b>				
Loads	5 x 5A	5 x 5A	6 x 5A	
<b>Other outputs</b>				
Digital™ compressor				
Inverter-compressor	4÷20mA/0÷10V opt	4÷20mA/0÷10V opt	4÷20mA/0÷10V opt	
Inverter-fans	4÷20mA/0÷10V opt	4÷20mA/0÷10V opt	4÷20mA/0÷10V opt	
Load	12V/40mA	12V/40mA		
Hot Key/Prog Tool Kit	pres	pres	pres	
Serial	TTL	TTL	RS485	
<b>Other</b>				
Remote keyboard			VC660	
Alarms	last 10	last 10	last 10	
Buzzer	opt	opt	pres	opt
Connection kit	CW15-KIT, CW25-KIT, CAB/CJ15, CAB/CJ30	CW15-KIT, CW25-KIT, CAB/CJ15, CAB/CJ30		

## XC650CX - XC652CX

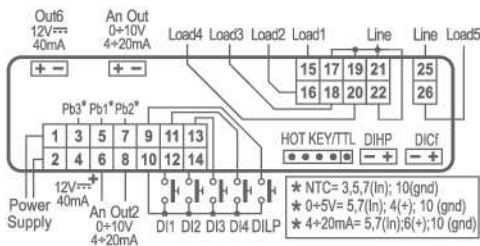

## XC660D

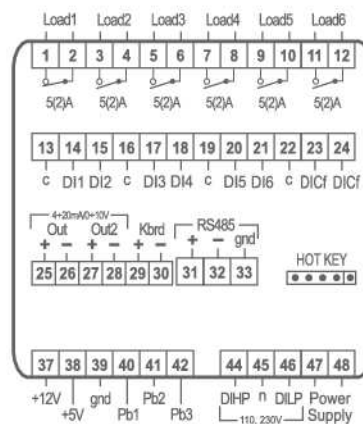



## XC1000 SERIES: up to 15 COMPRESSOR/FAN OUTPUT APPLICATIONS

- Electronic controllers for compressors and condensing fans management of medium-large compressor racks
- Scroll, semi-hermetic, multi stages, with different power and screw compressor management
- Concise information about the variables of the compressor rack through the VISOGRAPH display
- 2 analogue outputs for frequency compressors
- 2 analogue outputs for inverter for fans
- Hourly run time signals for maintenance
- Sub-cooling management
- Subcritical CO<sub>2</sub> regulation
- Compressor unloading in case of high condensing pressure alarm
- Suction superheat calculation with alarm management and possible stop of compressors
- Liquid injection valve activation to increase superheat
- Alarm management with absolute and relative pressure
- Hot Key or Prog Tool Kit connector for quick and easy programming
- Serial connection to monitoring systems
- 12VA max power absorption

### HOW to ORDER

XC1000D    X C 1 0    D - 1 B 0 D E

B	D	E
Measurement unit	4÷20mA/0÷10V	Inputs
C = °C	0 = No	C = NTC
F = °F	1 = Yes	D = PTC
B = Bar		E = 4÷20mA
P = PSI		F = Suction PP11; Condensing PP30
K = KPA		G = Ratiometric

VGC810    V G C 8 1 0 - A B 0 0 0

A	B
Buzzer	Kind of mounting
0 = No	P = Panel
1 = Yes	W = Wall

## KINDS OF CIRCUIT

The XC1000D series is able to manage in the best possible way the majority of applications for refrigeration circuits.

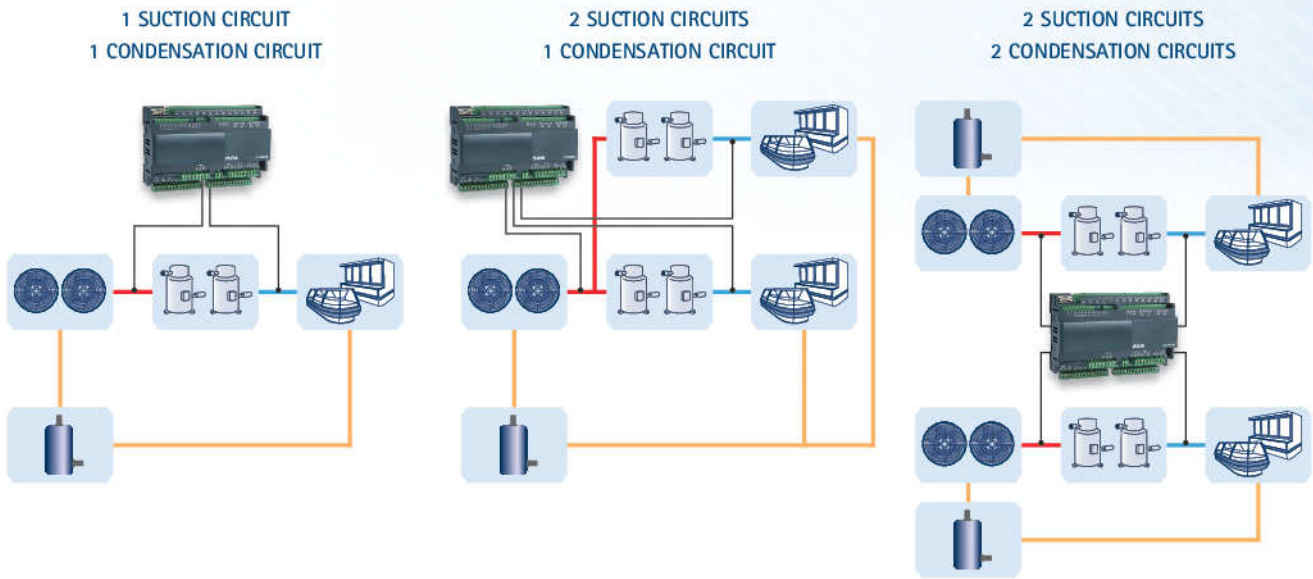

## CO<sub>2</sub> REGULATION

CO<sub>2</sub> use is increasing thanks to the advantages it offers in cooling plants. For this reason there is also a greater demand for accessories. Thanks to special algorithms, the XC1000D series can manage and monitor CO<sub>2</sub> plants that work in cascade connection with sub-critical cycle.



## COMPATIBILITY with DIGITAL™ COMPRESSORS

Thanks to its powerful hardware platform and to the advanced algorithms, the XC1000D family is able to drive the majority of compressor racks present in the market. An interesting match is the one with Dixell XEV02D driver that allows management of compressor racks equipped with Digital™ compressors. In these applications, by using the modulating capacity, the plant receives the optimum refrigeration power thereby reducing consumption.

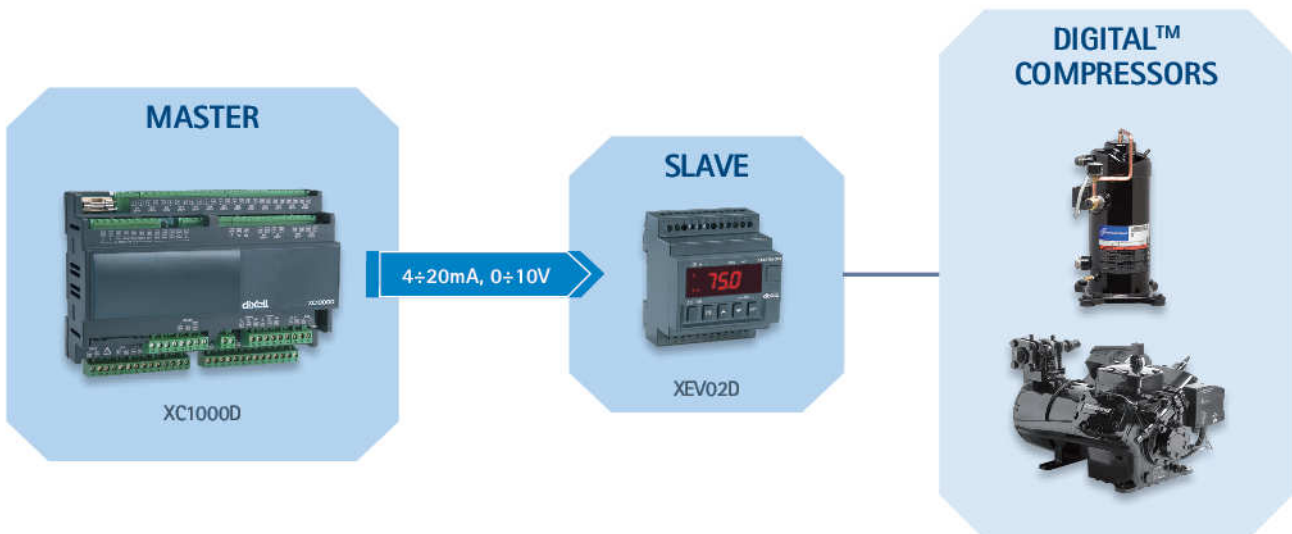

## ENERGY SAVING MANAGEMENT

The XC1000D series gives to the user several solutions that let you to manage energy savings. The controllers have a special algorithm that lets you to optimize the efficiency of the plant, ensuring energy savings. The following are a range of the most important solutions that Dixell offers to customers to achieve energy savings.

### COMPRESSORS with INVERTER

When the plant needs more power (when the temperature gets out of the band) the inverter compressor frequency increases. If this is not enough, the other compressors (C2, C3, ...) will be activated in sequence. At the same time the controller will modulate the inverter compressor frequency in order to have a uniform increase of the plant power.

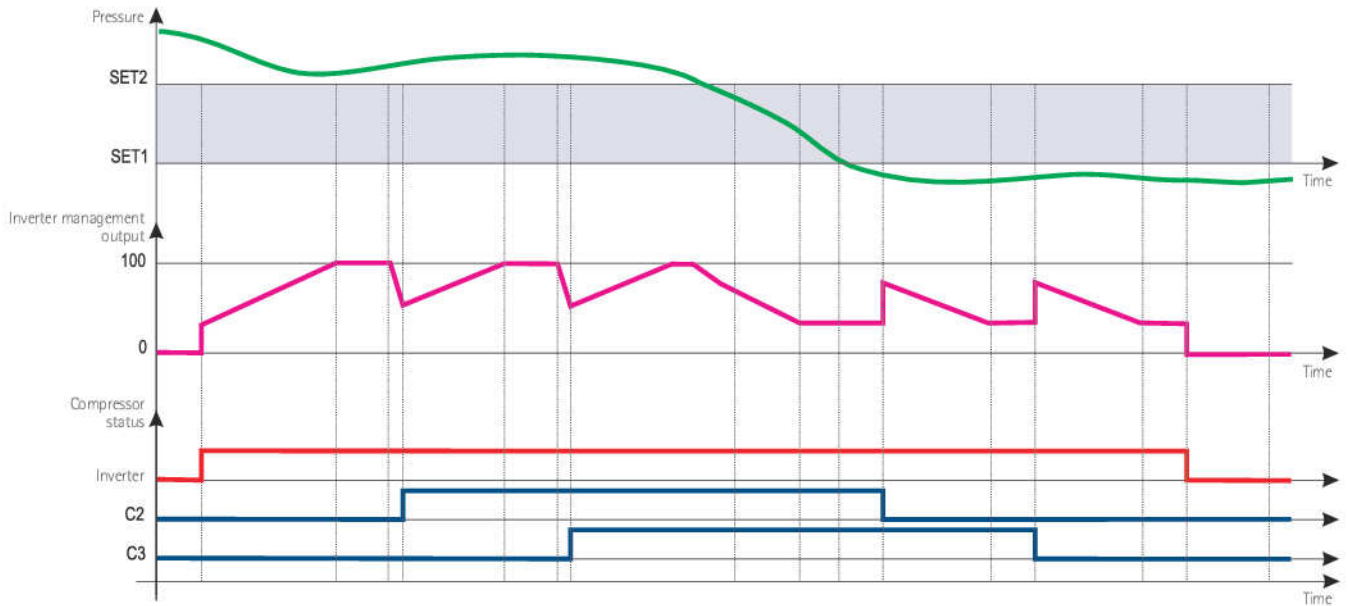

### EC FANS – INVERTER

In this case all condensing fans are driven by one inverter or are EC fans.

The inverter power is proportional to the condensing pressure value and the analog output is modulated proportionally to the condensing pressure/temperature over the set (SET1÷SET2). Under SET1 the output will be switched off, over the SET2 the output is at 100%.

The relay set as inverter will be activated if the condensing pressure/temperature is higher than the SET1 and switched off when the condensing pressure is lower than the SET1. It can be used to allow the inverter regulation.

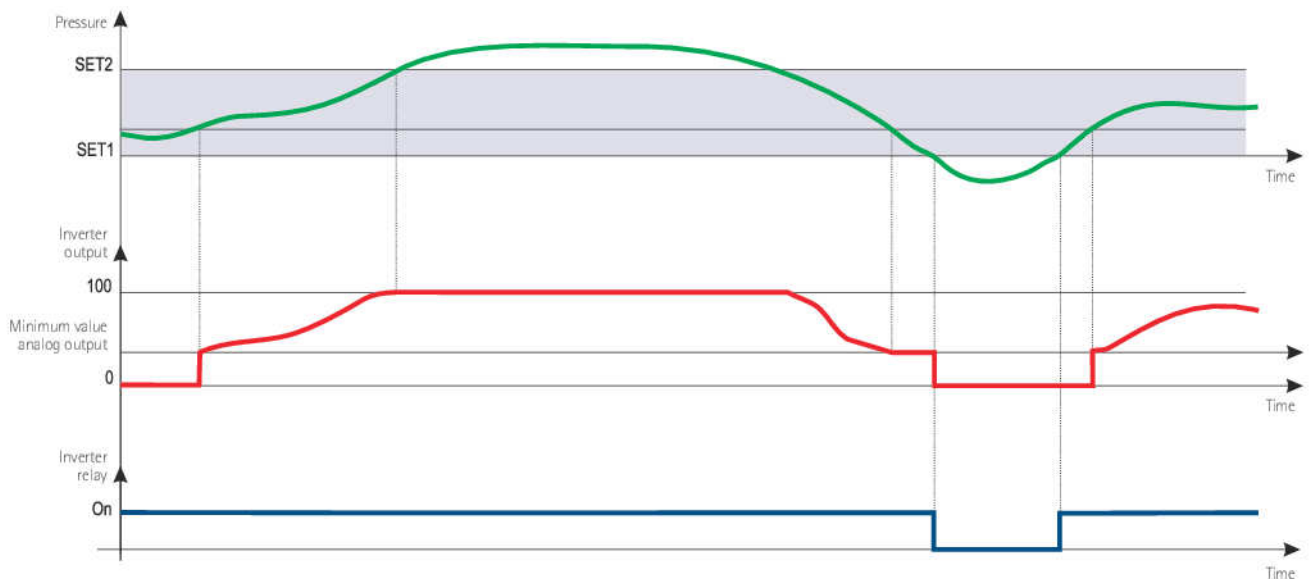

### SUCTION DYNAMIC SET POINT

Suction temperature/pressure optimization can depend on retail space temperature.

The dynamic set point guarantees excellent plant efficiency, considering the real operational conditions. The plant modifies the suction temperature/pressure according to the retail space temperature so the refrigeration power changes depending on the real thermodynamic exchange.

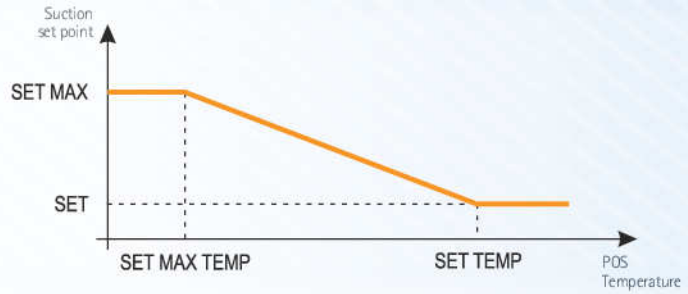

### CONDENSER DYNAMIC SET POINT

Condenser temperature/pressure optimization can depend on the external temperature.

The condenser temperature/pressure is modified according to the external temperature. The condensing set point is automatically adjusted according to the external temperature, to get an optimum condensing temperature.

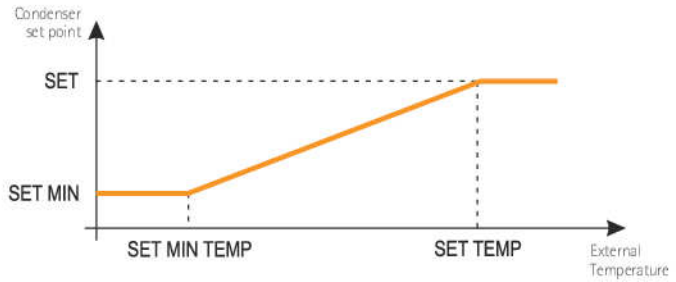

### REDUCED SET POINT

An internal 7 day clock can automatically change the adjustment's set point, depending on a particular system's individual requirements, to enter an energy saving cycle during nights and weekends, when less power is required. This energy saving cycle can also be initiated from an external source via a digital input.

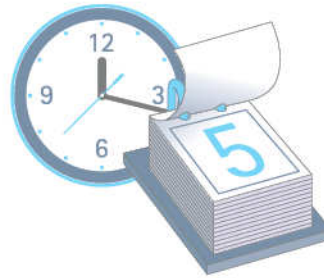

### SUPERVISION SET

The connection to the modern supervising systems (of Dixell) allows, thanks to the CRO (Compressor Rack Optimization), to manage in the best way the compressor rack set point depending on the devices connected, with the result of having an optimize energy saving on the plant. The system, equipped with the CRO function, analyzes the information from the controller in the application to determine if a controller needs more refrigeration power and the quantity. The set point will be re-calculated in order to satisfy the worse instance and sent from the supervising system to the XC1000D; this will be the working set point (fig. 1). If the supervising system can't manage the XC1000D, is the controller that "decided" to replace the set point (coming from the system) and will then define the set point in the program phase.

fig. 1



The 2 graphs (fig. 2) emphasize that when the CRO algorithm is active, in a real installation, the set point becomes on average higher, and consequently the energy consumption decreases. The dotted line represents the average weekly value.

fig. 2

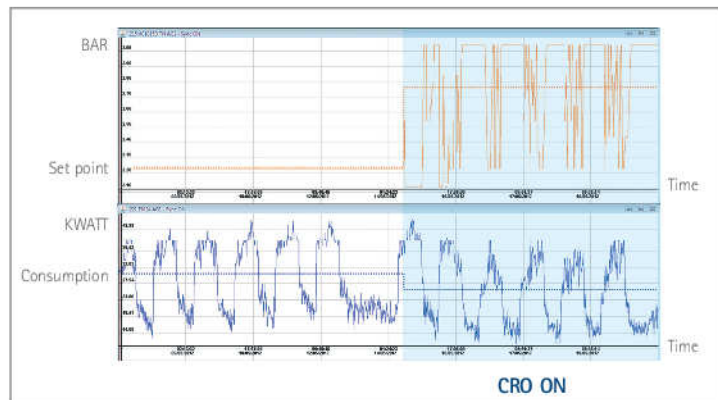

# XC1000

## Up to 11 COMPRESSOR and FAN COMPRESSOR RACK CONTROLLERS



D: 10 DIN Rail

- XC1008D** | Digital controller for simultaneous management of up to 8 compressors and fans
- XC1011D** | Digital controller for simultaneous management of up to 11 compressors and fans

FEATURES	XC1008D	XC1011D
<b>Display</b>	LCD on VGC810	LCD on VGC810
<b>Power supply</b>	24Vac/dc (from TF10D)	24Vac/dc (from TF20D)
<b>Probe inputs</b>		
Suction	NTC, PTC, 4÷20mA, 0÷5V	NTC, PTC, 4÷20mA, 0÷5V
Suction 2		NTC, PTC, 4÷20mA, 0÷5V
Condensing	NTC, PTC, 4÷20mA, 0÷5V	NTC, PTC, 4÷20mA, 0÷5V
Condensing 2		NTC, PTC, 4÷20mA, 0÷5V
Auxiliary	NTC, PTC	NTC, PTC
Auxiliary 2	NTC, PTC	NTC, PTC
Auxiliary 3		NTC, PTC
Auxiliary 4		NTC, PTC
<b>Digital inputs</b>		
Low pressure switch	1	1
Low pressure switch 2		1
High pressure switch	1	1
High pressure switch 2		1
Safety loads	8	11
Configurable	4	4
<b>Relay outputs</b>		
Loads	8 x 7A config	11 x 7A config
Alarms	2 x 8A	2 x 8A
<b>Other outputs</b>		
Inverter compressors	4÷20mA/0÷10V opt	2 x 4÷20mA/0÷10V opt
Inverter fans	4÷20mA/0÷10V opt	2 x 4÷20mA/0÷10V opt
Hot Key/Prog Tool Kit	pres	pres
Visokey		
Serial	RS485	RS485
<b>Other</b>		
Remote display	VGC810	VGC810
Alarms	last 100	last 100
Buzzer	on keyboard	on keyboard

### XC1008D - XC1011D

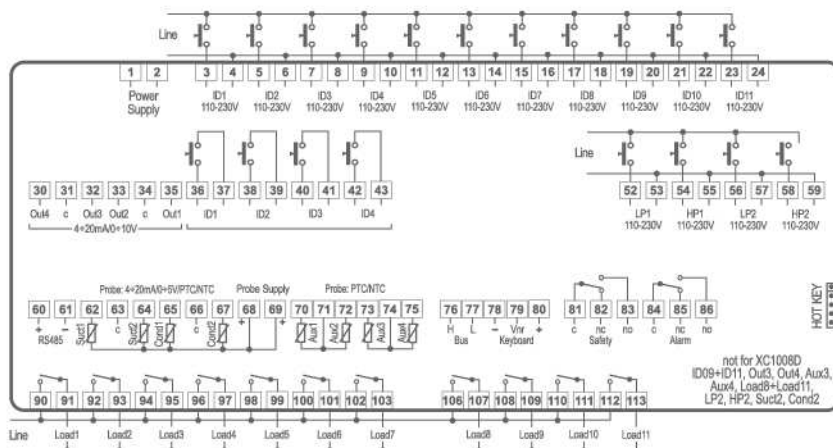



# CONTROLLER and GRAPHIC DISPLAY for COMPRESSOR RACKS with up to 15 COMPRESSORS and FANS

# XC1000

- XC1015D** | Digital controller for simultaneous management of up to 15 compressors and fans
- VGC810** | Remote keyboard with LCD graphic display and interface dedicated to the management of compressor racks by means of XC1000D controllers (IP65 front protection)



D: 10 DIN Rail



VG: 82x156mm

FEATURES	XC1015D	VGC810
<b>Display</b>	LCD on VGC810	LCD - 240x96pixels
<b>Power supply</b>	24Vac/dc (from TF20D)	from controller
<b>Probe inputs</b>		
Suction	NTC, PTC, 4÷20mA, 0÷5V	
Suction 2	NTC, PTC, 4÷20mA, 0÷5V	
Condensing	NTC, PTC, 4÷20mA, 0÷5V	
Condensing 2	NTC, PTC, 4÷20mA, 0÷5V	
Auxiliary	NTC, PTC	
Auxiliary 2	NTC, PTC	
Auxiliary 3	NTC, PTC	
Auxiliary 4	NTC, PTC	
<b>Digital inputs</b>		
Low pressure switch	1	
Low pressure switch 2	1	
High pressure switch	1	
High pressure switch 2	1	
Safety loads	15	
Configurable	4	
<b>Relay outputs</b>		
Loads	15 x 7A config	
Alarms	2 x 8A	
<b>Other outputs</b>		
Inverter compressors	2 x 4÷20mA/0÷10V opt	
Inverter fans	2 x 4÷20mA/0÷10V opt	
Hot Key/Prog Tool Kit	pres	
Visokey		pres
Serial	RS485	
<b>Other</b>		
Remote display	VGC810	
Alarms	last 100	
Buzzer	on keyboard	opt

## XC1015D

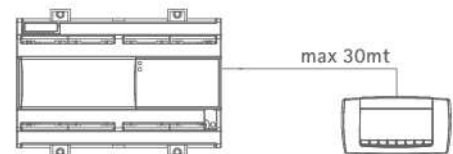
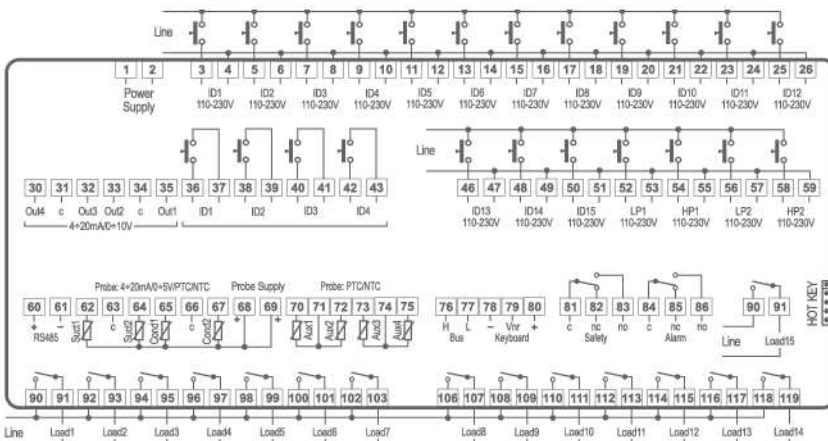



## iProRACK SERIES: up to 2 CIRCUIT and 6 COMPRESSOR per CIRCUIT APPLICATIONS

- Electronic controllers for compressor racks studied to manage even the most complex installations
- Management of scroll, semi-hermetic, multi-stages, different capacity and screw compressors
- Management of 2 circuits with 2 inverters
- Transcritical CO<sub>2</sub> regulation
- Special algorithms for energy saving
- Suction and condensing dynamic set point optimization
- Sub-cooling management
- Copeland Stream CoreSense™ diagnostics control module integration
- Concise information about the variables of the compressor rack through the VISOGRAPH
- Powerful platform with LINUX operating system on CPU ARM9 (200MHz/32bit)
- Ethernet for the connection to an intranet-internet network
- USB output for configuration update
- RS485 slave serial outputs for the connection to XWEB supervising and controlling systems
- Type of refrigerants: R22, R134A, R404A, R507, R717, R407, R407C, R407F

### HOW to ORDER

IPR208D	I	P	R	2	0	8	D	-	1	0	C	2	0
IPR215D	I	P	R	2	1	5	D	-	1	0	C	0	0

**C**

#### Ethernet, protocols

0 = No  
1 = Yes

VGIPG	V	G	I	P	G	-	A	B	0	D	0
-------	---	---	---	---	---	---	---	---	---	---	---

**A**

**B**

**D**

Buzzer	Kind of mounting	Coding
0 = No	P = Panel	0 = Ascii
1 = Yes	W = Wall	1 = Unicode

## INTERNAL WEB SERVER

The iProRACK controllers have an integrated web site that can be easily reached through a standard browser. This instrument is very useful to configure the controller and to display and change the machine variables.

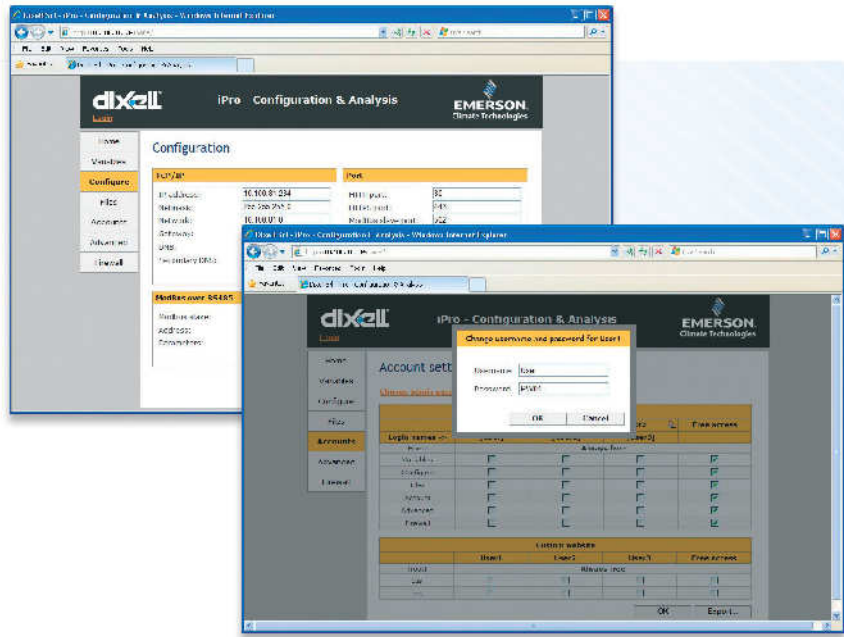

## MAIN FEATURES

- CPU: 200MHz
- Processor: 32bit
- RAM memory: 32MB (4 DIN Rail), 64MB (10 DIN Rail)
- Data storage on Flash memory: 32MB (4 DIN Rail), 128MB (10 DIN Rail)
- Power absorption: 40VA max (4 DIN Rail), 20VA max (10 DIN Rail)

## CONNECTIVITY

The powerful platform that marks the iProRACK controllers and allows the compressor rack to be easily and quickly reached both locally and remotely. In addition to the connection via Ethernet, there is also one via RS485 that allows the connection to XWEB systems, ensuring complete plant monitoring and controlling.

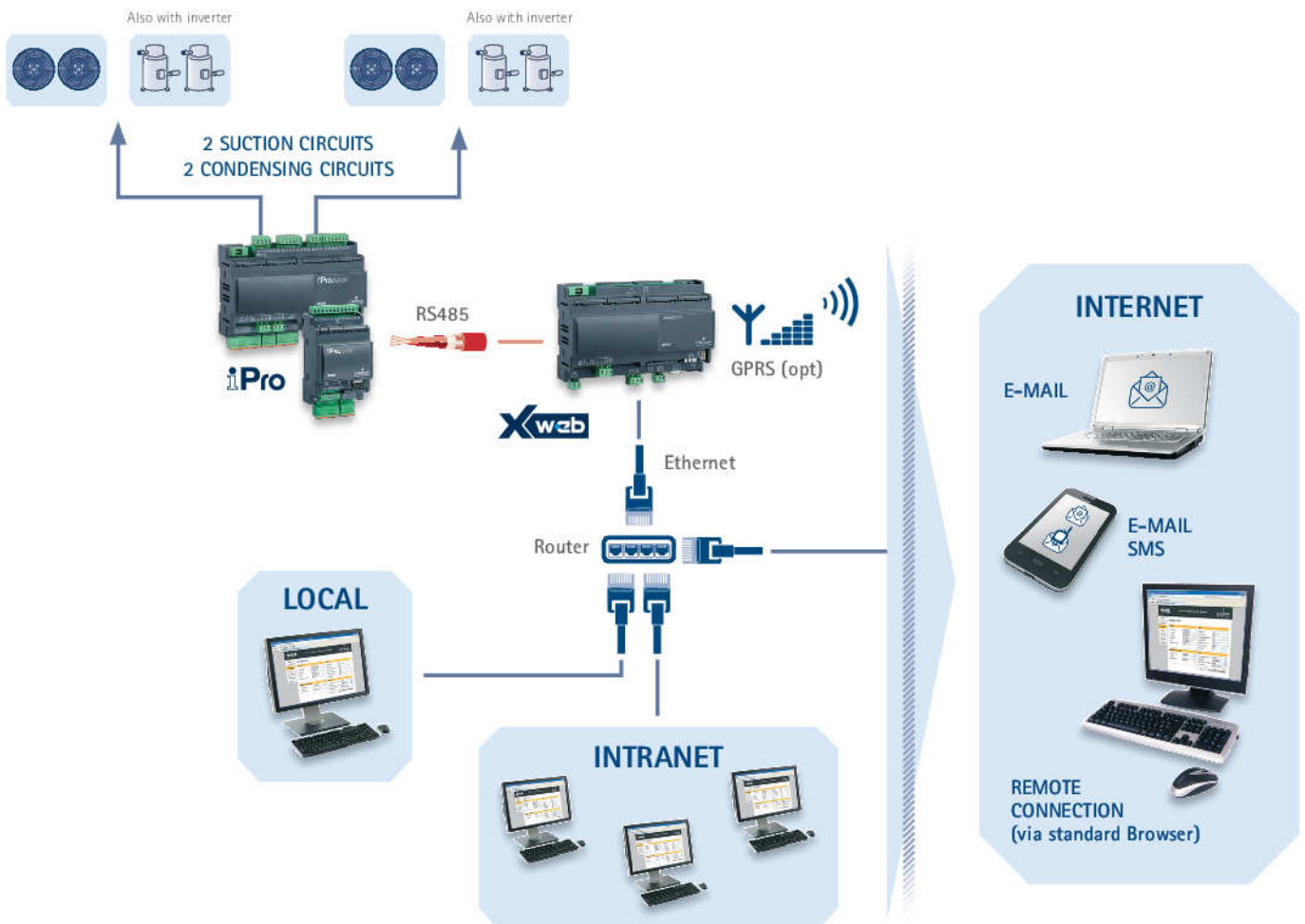



D: 10 DIN Rail    D: 4 DIN Rail    VG: 82x156mm

<b>IPR208D</b>	Digital controller in 4 DIN Rail format with bayonet + screw connectors for compressor rack management
<b>IPR215D</b>	Digital controller in 10 DIN Rail format with bayonet + screw connectors for compressor rack management
<b>VGIPG</b>	Remote keyboard with LCD graphic display and interface dedicated to the management of compressor racks by means of iProRACK controllers (IP65 front protection)

FEATURES	IPR208D	IPR215D	VGIPG
<b>Display</b>	LCD on VGIPG	LCD on VGIPG	LCD - 240x96pixels
<b>Power supply</b>	24Vac/dc from TF40D	24Vac/dc from TF20D	from controller
<b>Probe inputs</b>			
0÷1V, 0÷5V, 0÷10V, 0÷20mA, 4÷20mA, NTC, PTC, DI	6 x config	10 x config	
<b>Digital inputs</b>			
Opto-insulated	11 x config	20 x config	
<b>Relay outputs</b>			
Configurable	8 x 5A	15 x 5A	
<b>Other outputs</b>			
0÷10V/4÷20mA	4 x config	2 x config	
0÷10V		4	
RS485	master + slave	master + slave	
USB	pres	pres	
CANBus	pres	pres	
Ethernet	via USB-ETH-CONV	opt	
Visokey			pres
<b>Other</b>			
Remote display	1 x VGIPG	2 x VGIPG	
Real time clock	pres	pres	
Flash memory	32MB	128MB	
Connections	bayonet + screw	bayonet + screw	
Connection kit	IP-FC208	IP-FC215CP	
BACnet protocol	opt	opt	
Buzzer			opt

### IPR208D

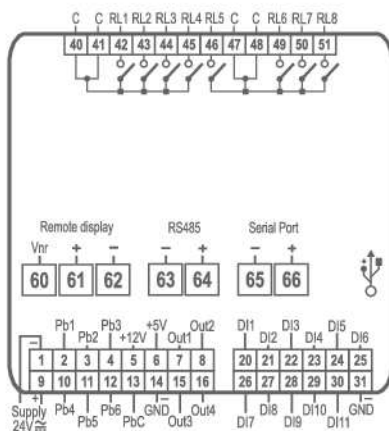

### IPR215D

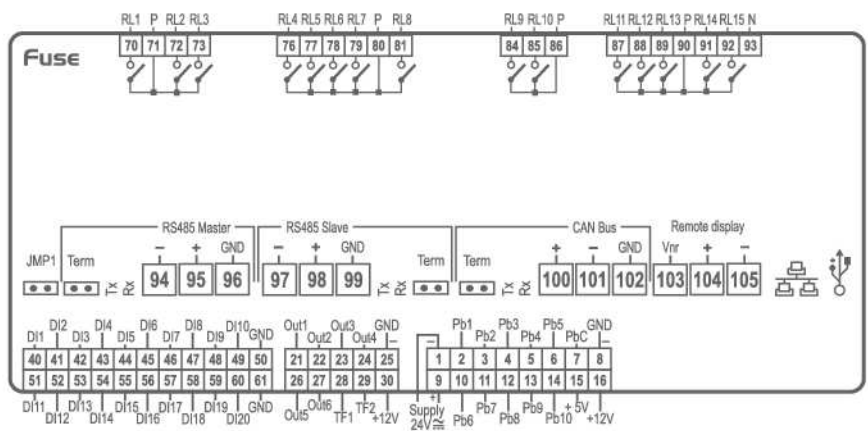



# FAN SPEED CONTROLLERS

## SECTION INDEX

FUNCTIONS	MODELS	
<b>XV300 – three-phase fan speed control</b>		<b>94</b>
Three-phase speed controllers	XV308K – XV310K – XV312K XV320K – XV328K – XV340K	95
<b>XV05/10/22/100 – single-phase fan speed control</b>		<b>96</b>
Single-phase speed controllers	XV05PD – XV05PK – XV10PK XV22PK – XV105D – XV110K XV150K	97
Accessory	XV-ACK	98



## XV300 SERIES: THREE-PHASE FAN SPEED CONTROL

- Chopped phase regulators designed for 3-phase fans with adjustable voltage motors
- Designed for adjustable voltage motors from 8 to 40A
- Oversized heat sinks for better heat disposal
- Integrated heat protection
- Oversized power stages
- Optimized radiofrequency filters
- Available with ABS self-extinguishing cover (IP55) or in aluminum (IP20)
- Less time spent for wiring operations thanks to the screwless connectors with useful cable protectors
- On board 0÷10V output to be used for testing operation
- Compatible with Dixell controllers equipped with PWM, 4÷20mA, 0÷10V outputs like the iPro, XC600, XM600, ... series

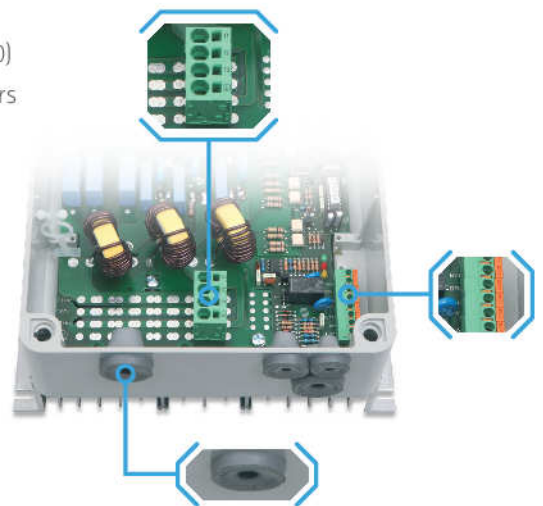

### HOW to ORDER

XV308/312/328/340K

X	V	3			K	-	7	0	1	0	0
---	---	---	--	--	---	---	---	---	---	---	---

XV310K

X	V	3	1	0	K	-	7	0	0	0	0
---	---	---	---	---	---	---	---	---	---	---	---

XV320K

X	V	3	2	0	K	-	7	0	C	0	0
---	---	---	---	---	---	---	---	---	---	---	---

C

#### Protection grade

0 = IP20

1 = IP55

# THREE-PHASE SPEED CONTROLLERS

# XV300

<b>XV308K</b>	Speed controller designed for three-phase A.C. motors up to 5,5kVA, 8A, with input for PWM, 4÷20mA or 0÷10V, dimension 165x230mm, weight 2,5Kg, power dissipation 30W
<b>XV310K</b>	Speed controller designed for three-phase A.C. motors up to 6,5VA, 10A, with input for PWM, 4÷20mA or 0÷10V, dimension 165x230mm, weight 3Kg, power dissipation 40W
<b>XV312K</b>	Speed controller designed for three-phase A.C. motors up to 8kVA, 12A, with input for PWM, 4÷20mA or 0÷10V, dimension 230x265mm, weight 4Kg, power dissipation 60W
<b>XV320K</b>	Speed controller designed for three-phase A.C. motors up to 13kVA, 20A, with input for PWM, 4÷20mA or 0÷10V, dimension 230x265mm, weight 4,8Kg, power dissipation 80W
<b>XV328K</b>	Speed controller designed for three-phase A.C. motors up to 19kVA, 28A, with input for PWM, 4÷20mA or 0÷10V, dimension 270x340mm, weight 7Kg, power dissipation 120W
<b>XV340K</b>	Speed controller designed for three-phase A.C. motors up to 26kVA, 40A, with input PWM, 4÷20mA or 0÷10V, dimension 270x340mm, weight 9Kg, power dissipation 155W



K: 165x230mm



K: 230x265mm



K: 270x340mm

FEATURES	XV308K	XV310K	XV312K	XV320K	XV328K	XV340K
Power supply	400Vac	400Vac	400Vac	400Vac	400Vac	400Vac
Protection grade	IP55	IP20	IP55	IP55, IP20	IP55	IP55
Maximum load	8A	10A	12A	20A	28A	40A
Control input	PWM 4÷20mA 0÷10V	PWM 4÷20mA 0÷10V	PWM 4÷20mA 0÷10V	PWM 4÷20mA 0÷10V	PWM 4÷20mA 0÷10V	PWM 4÷20mA 0÷10V
Alarm relay			1A, 250Vac 3A, 30Vdc	1A, 250Vac 3A, 30Vdc	1A, 250Vac 3A, 30Vdc	1A, 250Vac 3A, 30Vdc
Auxiliary output	10Vdc	10Vdc	10Vdc	10Vdc	10Vdc	10Vdc
Supply LED	pres	pres	pres	pres	pres	pres
Alarm LED	pres	pres	pres	pres	pres	pres
Relay ON LED			pres	pres	pres	pres

XV308K - XV310K

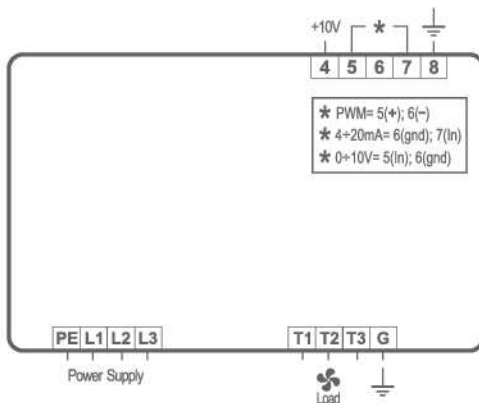

XV312K - XV320K - XV328K - XV340K

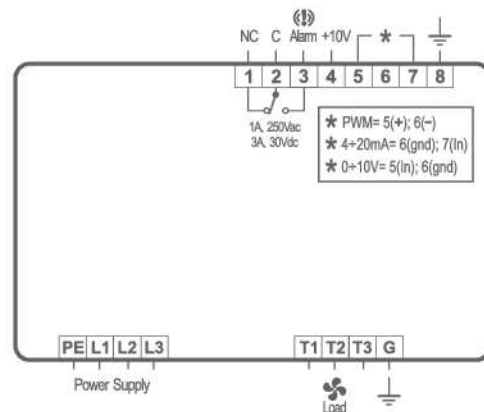



K: 175x200mm



K: 139x158mm



PK: 80x70mm



D: 4 DIN Rail

## XV05/10/22/100 SERIES: SINGLE-PHASE FAN SPEED CONTROL

- Chopped phase speed controllers to control pressure and temperature in refrigerating systems including cooling fans
- Inputs for regulation by temperature and pressure
- Direct or inverse action for condenser or evaporator fans
- Cut off, minimum speed and max speed at start up functions
- Trigger output for managing another module
- Slave models managed by the input signal (for XV100)
- Compatible with Dixell controllers equipped with PWM, 4÷20mA, 0÷1V/0÷10V outputs like the iPro, XC600, XM600, ... series
- 1VA max power absorption
- Measurement range: 0÷100%

### HOW to ORDER

XV05PD

X	V	0	5	P	D	-	5	0	0	0	0
---	---	---	---	---	---	---	---	---	---	---	---

XV05/10/22PK

X	V			P	K	-	5	0	0	0	0
---	---	--	--	---	---	---	---	---	---	---	---

XV100

X	V	1				-	5	B	C	D	0
---	---	---	--	--	--	---	---	---	---	---	---

B	C	D
<b>Format</b>	<b>Type of action</b>	<b>Regulation input</b>
0 = DIN	D = Direct + Cut Off	N = NTC probe
5 = Enclosure IP55	R = Inverse + Cut Off	A = Current (4÷20mA)
	N = Slave (not for regulation input = N)	V = 0÷1V/0÷10V



<b>XV05PD</b> <b>XV05PK</b>	Speed controllers designed for single-phase A.C. motors up to 500W, 2A, PWM input
<b>XV10PK</b>	Speed controller designed for single-phase A.C. motors up to 1000W, 4A, PWM input
<b>XV22PK</b>	Speed controller designed for single-phase A.C. motors up to 2200W, 9,5A, PWM input



PD: 4 DIN Rail



PK: 80x70mm

FEATURES	XV05PD	XV05PK	XV10PK	XV22PK
Power supply	230Vac	230Vac	230Vac	230Vac
Control input	PWM	PWM	PWM	PWM
Direct-inverse function				
Full speed input at start up				
Trigger signal	pres	pres	pres	pres
Minimum speed function				
Cut off function				

**XV05PD**

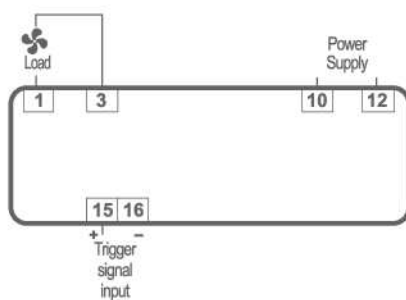

**XV05PK - XV10PK - XV22PK**

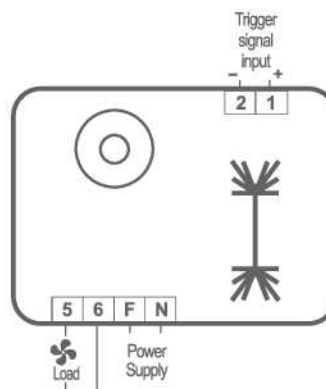

# XV100

## SINGLE-PHASE SPEED ADVANCED CONTROLLERS



D: 4 DIN Rail



K: 139x158mm



K: 175x200mm

<b>XV105D</b>	Speed controller designed for single-phase A.C. motors up to 500W, with input for NTC, 4±20mA, 0÷1V or 0÷10V
<b>XV110K</b>	Speed controller designed for single-phase A.C. motors up to 1kW, with input for NTC, 4±20mA, 0÷1V or 0÷10V
<b>XV150K</b>	Speed controller designed for single-phase A.C. motors up to 5kW, with input for NTC, 4±20mA, 0÷1V or 0÷10V

FEATURES	XV105D	XV110K	XV150K
Power supply	230Vac	230Vac	230Vac
Control input	NTC 4±20mA 0÷1V/0÷10V	NTC 4±20mA 0÷1V/0÷10V	NTC 4±20mA 0÷1V/0÷10V
Direct-inverse function	pres	pres	pres
Full speed input at start up	pres	pres	pres
Trigger signal	pres	pres	pres
Minimum speed function	pres	pres	pres
Cut off function	pres	pres	pres

### XV105D

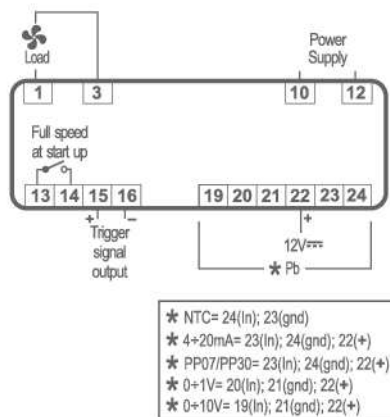

### XV110K - XV150K

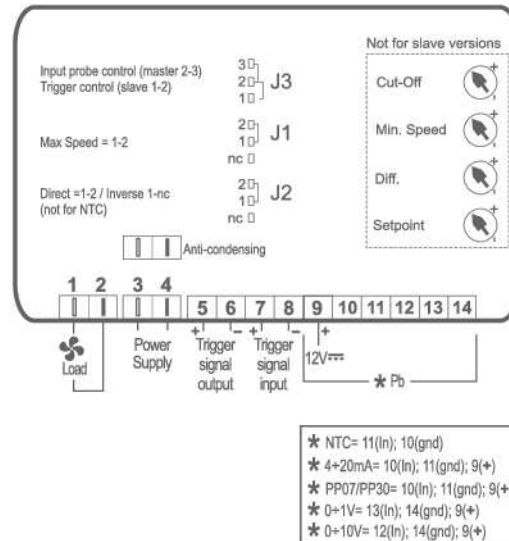

## ACCESSORY

### XV-ACK

Anti-condensing kit for XV110K and XV150K models

- Resistance at 25°C (77°F): 100±6000hm
- Rated operating voltage: 120Vac or 220Vac
- Max operating voltage: 260Vac
- Steady state current at 25°C (77°F): 12A±30% (120Vac) 9A±30% (220Vac)





# TEMPERATURE/HUMIDITY/PRESSURE CONTROLLERS

## SECTION INDEX

FUNCTIONS	MODELS	
<b>XT100 – NTC, PTC, Pt100, TcJ, TcK, TcS, 4÷20mA, 0÷1V, 0÷10V multi-probe input</b>		<b>100</b>
1 stage digital controllers	XT110C – XT110D XT111C – XT111D	101
2 stage digital controllers	XT120C – XT120D XT121C – XT121D	102
Neutral zone digital controllers	XT130C – XT130D XT131C – XT131D	103
2 stage digital controllers (1 PID)	XT141C – XT141D	104
3 stage digital controller	XT151D	104
4 stage digital controller	XT160D	104



C: 32x74mm



D: 4 DIN Rail



## XT100 SERIES: NTC, PTC, Pt100, TcJ, TcK, TcS, 4÷20mA, 0÷1V, 0÷10V MULTI-PROBE INPUT

- Universal controllers to manage temperature, humidity and pressure in both the industrial and commercial applications
- Stock optimization: thanks to the multi-probe inputs
- 1 or 2 stage ON/OFF or PID with direct or reverse action
- Temperature inputs: PTC, NTC, Pt100; thermocouple J, K or S by selecting the parameters
- Pressure or humidity inputs: 4÷20mA, 0÷1V or 0÷10V by selecting the parameters
- Direct line power supply 230 (110)Vac. No external transformer required
- Display with integrated measurement unit (°C/°F/%RH/Bar/PSI)
- Hot Key or Prog Tool Kit connector for quick and easy programming
- Serial connection to monitoring systems
- 3VA max power absorption
- Display with red LED (10,5 mm high) and 5 icons

### HOW to ORDER

XT100 

X	T	1				-	A	B	C	D	U
---	---	---	--	--	--	---	---	---	---	---	---

-17.8 For blue display please contact Dixell

A	B	C	D
<b>Power supply</b>	<b>Measurement unit</b>	<b>Buzzer</b>	<b>Analog output</b>
0 = 12Vac/dc	C = °C	0 = No	No
1 = 24Vac/dc	F = °F	1 = Yes	No
2 = 24Vac	B = Bar	2* = No	4÷20mA
4 = 110Vac	P = PSI	3* = Yes	4÷20mA
5 = 230Vac	H = %RH	4* = No	0÷10V
	N = No measurement unit	5* = Yes	0÷10V
		* Only for D format	
		<b>Input</b>	
		P = PTC (NTC)	
		T = PTC (NTC, Pt100, TcJ, TcK, TcS)	
		A = 4÷20mA, 0÷1V, 0÷10V	
		B = PP07 (-0.5÷7bar)	
		C = PP30 (0÷30bar)	
		D = PP11 (-0.5÷11bar)	
		H = XH10/20P	

# 1 STAGE CONTROLLERS

# XT100

**XT110C**  
**XT110D**

ON/OFF configurable digital 1 stage controllers

**XT111C**  
**XT111D**

ON/OFF configurable digital 1 stage controllers with alarm relay



C: 32x74mm

D: 4 DIN Rail

FEATURES	XT110C	XT110D	XT111C	XT111D
Display: n° digits	± 3½ d.p.	± 3½ d.p.	± 3½ d.p.	± 3½ d.p.
Power supply	12, 24Vac/dc 110, 230Vac	24Vac/dc 24, 110, 230Vac	12, 24Vac/dc 110, 230Vac	24Vac/dc 24, 110, 230Vac
Probe inputs				
NTC, PTC, Pt100, TcJ, TcK, TcS, 4÷20mA, 0÷1V, 0÷10V	config	config	config	config
Relay outputs				
Stage 1	8A	no 8A/nc 5A	8A	no 8A/nc 5A
Stage 2				
Stage 3				
Stage 4				
Alarm			8A	no 8A/nc 5A
Other				
Digital input	pres	pres	pres	pres
Hot Key/Prog Tool Kit output	pres*	pres	pres*	pres
Serial output	TTL*	TTL	TTL*	TTL
Analog output		4÷20mA, 0÷10V		4÷20mA, 0÷10V
Buzzer	opt	opt	opt	opt

\* Prog Tool Kit output and serial output only for models with 12/24Vac/dc probe supply

## XT110C

- \* 4÷20mA, 0+1V, 0+10V= 9(In); 11(gnd); 10(+)
- \* Pt100= 9 - 11(10) \* NTC, PTC= 9(In); 10(gnd)
- \* TcK, TcJ, TcS= 9(+)- 11(-)

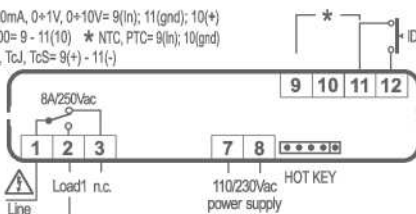

- \* 4÷20mA, 0+1V, 0+10V= 7(In); 9(gnd); 8(+)
- \* Pt100= 7 - 9(8) \* NTC, PTC= 7(In); 8(gnd)
- \* TcK, TcJ, TcS= 7(+)- 9(-)

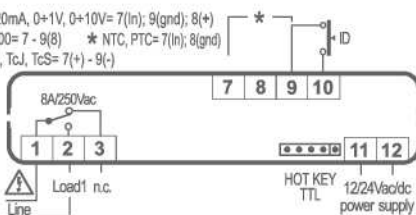

## XT111C

- \* 4÷20mA, 0+1V, 0+10V= 9(In); 11(gnd); 10(+)
- \* Pt100= 9 - 11(10) \* NTC, PTC= 9(In); 10(gnd)
- \* TcK, TcJ, TcS= 9(+)- 11(-)

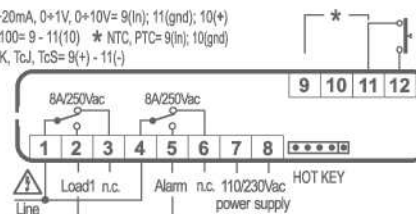

- \* 4÷20mA, 0+1V, 0+10V= 7(In); 9(gnd); 8(+)
- \* Pt100= 7 - 9(8) \* NTC, PTC= 7(In); 8(gnd)
- \* TcK, TcJ, TcS= 7(+)- 9(-)

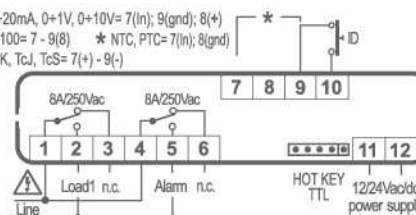

## XT110D

- \* 4÷20mA, 0+1V, 0+10V= 11(In); 10(gnd); 12(+)
- \* Pt100= 11 - 10(12) \* NTC, PTC= 11(In); 12(gnd)
- \* TcK, TcJ, TcS= 11(+)- 10(-)

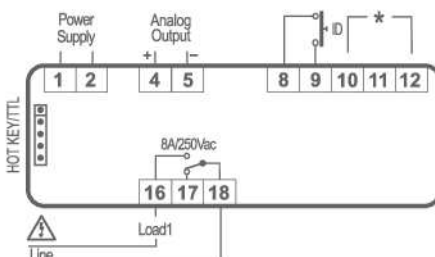

## XT111D

- \* 4÷20mA, 0+1V, 0+10V= 11(In); 10(gnd); 12(+)
- \* Pt100= 11 - 10(12) \* NTC, PTC= 11(In); 12(gnd)
- \* TcK, TcJ, TcS= 11(+)- 10(-)

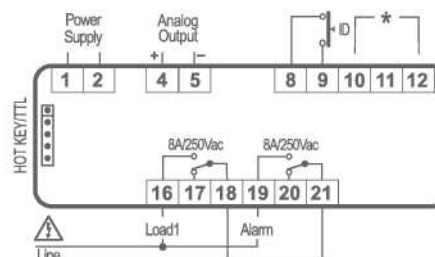

# XT100

## 2 STAGE CONTROLLERS



**XT120C  
XT120D**

ON/OFF configurable digital 2 stage controllers

**XT121C  
XT121D**

ON/OFF configurable digital 2 stage controllers with alarm relay

C: 32x74mm

D: 4 DIN Rail

FEATURES	XT120C	XT120D	XT121C	XT121D
<b>Display:</b> n° digits	± 3½ d.p.	± 3½ d.p.	± 3½ d.p.	± 3½ d.p.
<b>Power supply</b>	12, 24Vac/dc 110, 230Vac	24Vac/dc 24, 110, 230Vac	12, 24Vac/dc 110, 230Vac	24Vac/dc 24, 110, 230Vac
<b>Probe inputs</b>				
NTC, PTC, Pt100, TcJ, TcK, TcS, 4÷20mA, 0÷1V, 0÷10V	config	config	config	config
<b>Relay outputs</b>				
Stage 1	8A	no 8A/nc 5A	8A	no 8A/nc 5A
Stage 2	8A	no 8A/nc 5A	8A	no 8A/nc 5A
Stage 3				
Stage 4				
Alarm			8A	no 8A/nc 5A
<b>Other</b>				
Digital input	pres	pres	pres	pres
Hot Key/Prog Tool Kit output	pres*	pres	pres*	pres
Serial output	TTL*	TTL	TTL*	TTL
Analog output		4÷20mA, 0÷10V		4÷20mA, 0÷10V
Buzzer	opt	opt	opt	opt

\* Prog Tool Kit output and serial output only for models with 12/24Vac/dc probe supply

### XT120C

- \* 4÷20mA, 0÷1V, 0÷10V= 9(ln); 11(gnd); 10(+)
- \* Pt100= 9 - 11(10) \* NTC, PTC= 9(ln); 10(gnd)
- \* TcK, TcJ, TcS= 9(+)- 11(-)

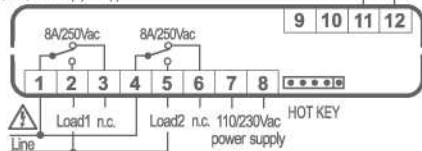

- \* 4÷20mA, 0÷1V, 0÷10V= 7(ln); 9(gnd); 8(+)
- \* Pt100= 7 - 9(8) \* NTC, PTC= 7(ln); 8(gnd)
- \* TcK, TcJ, TcS= 7(+)- 9(-)

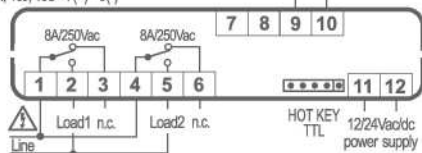

### XT121C

- \* 4÷20mA, 0÷1V, 0÷10V= 9(ln); 11(gnd); 10(+)
- \* Pt100= 9 - 11(10) \* NTC, PTC= 9(ln); 10(gnd)
- \* TcK, TcJ, TcS= 9(+)- 11(-)

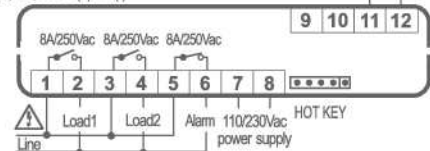

- \* 4÷20mA, 0÷1V, 0÷10V= 7(ln); 9(gnd); 8(+)
- \* Pt100= 7 - 9(8) \* NTC, PTC= 7(ln); 8(gnd)
- \* TcK, TcJ, TcS= 7(+)- 9(-)

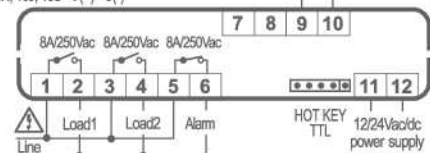

### XT120D

- \* 4÷20mA, 0÷1V, 0÷10V= 11(ln); 10(gnd); 12(+)
- \* Pt100= 11 - 10(12) \* NTC, PTC= 11(ln); 12(gnd)
- \* TcK, TcJ, TcS= 11(+)- 10(-)

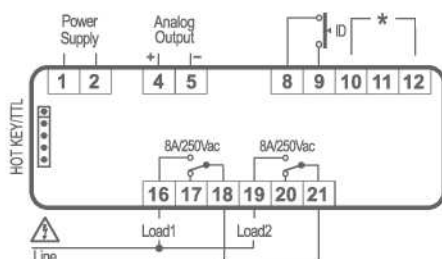

### XT121D

- \* 4÷20mA, 0÷1V, 0÷10V= 11(ln); 10(gnd); 12(+)
- \* Pt100= 11 - 10(12) \* NTC, PTC= 11(ln); 12(gnd)
- \* TcK, TcJ, TcS= 11(+)- 10(-)

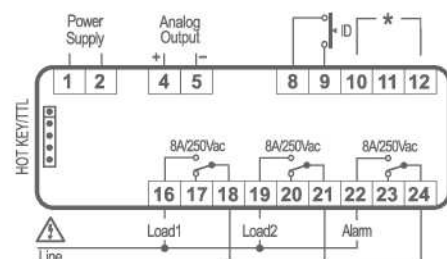

**XT130C**  
**XT130D** ON/OFF configurable digital neutral zone controllers

**XT131C**  
**XT131D** ON/OFF configurable digital neutral zone controllers with alarm relay



C: 32x74mm

D: 4 DIN Rail

FEATURES	XT130C	XT130D	XT131C	XT131D
Display: n° digits	± 3½ d.p.	± 3½ d.p.	± 3½ d.p.	± 3½ d.p.
Power supply	12, 24Vac/dc 110, 230Vac	24Vac/dc 24, 110, 230Vac	12, 24Vac/dc 110, 230Vac	24Vac/dc 24, 110, 230Vac
Probe inputs				
NTC, PTC, Pt100, TcJ, TcK, TcS, 4÷20mA, 0÷1V, 0÷10V	config	config	config	config
Relay outputs				
Stage 1	8A	no 8A/nc 5A	8A	no 8A/nc 5A
Stage 2	8A	no 8A/nc 5A	8A	no 8A/nc 5A
Stage 3				
Stage 4				
Alarm			8A	no 8A/nc 5A
Other				
Digital input	pres	pres	pres	pres
Hot Key/Prog Tool Kit output	pres*	pres	pres*	pres
Serial output	TTL*	TTL	TTL*	TTL
Analog output		4÷20mA, 0÷10V		4÷20mA, 0÷10V
Buzzer	opt	opt	opt	opt

\* Prog Tool Kit output and serial output only for models with 12/24Vac/dc probe supply

## XT130C

\* 4÷20mA, 0÷1V, 0÷10V= 9(In); 11(gnd); 10(+)  
\* Pt100= 9 - 11(10) \* NTC, PTC= 9(In); 10(gnd)  
\* TcK, TcJ, TcS= 9(+)- 11(-)

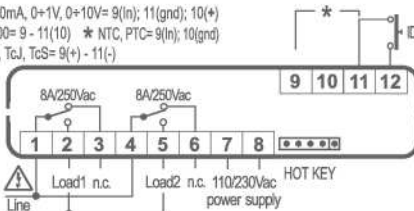

\* 4÷20mA, 0÷1V, 0÷10V= 7(In); 9(gnd); 8(+)  
\* Pt100= 7 - 9(8) \* NTC, PTC= 7(In); 8(gnd)  
\* TcK, TcJ, TcS= 7(+)- 9(-)

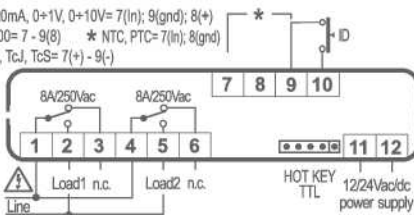

## XT131C

\* 4÷20mA, 0÷1V, 0÷10V= 9(In); 11(gnd); 10(+)  
\* Pt100= 9 - 11(10) \* NTC, PTC= 9(In); 10(gnd)  
\* TcK, TcJ, TcS= 9(+)- 11(-)

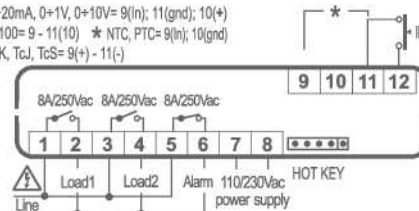

\* 4÷20mA, 0÷1V, 0÷10V= 7(In); 9(gnd); 8(+)  
\* Pt100= 7 - 9(8) \* NTC, PTC= 7(In); 8(gnd)  
\* TcK, TcJ, TcS= 7(+)- 9(-)

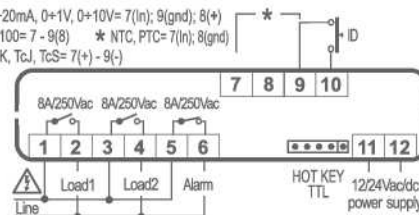

## XT130D

\* 4÷20mA, 0÷1V, 0÷10V= 11(In); 10(gnd); 12(+)  
\* Pt100= 11 - 10(12) \* NTC, PTC= 11(In); 12(gnd)  
\* TcK, TcJ, TcS= 11(+)- 10(-)

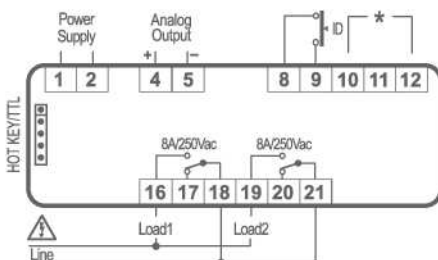

## XT131D

\* 4÷20mA, 0÷1V, 0÷10V= 11(In); 10(gnd); 12(+)  
\* Pt100= 11 - 10(12) \* NTC, PTC= 11(In); 12(gnd)  
\* TcK, TcJ, TcS= 11(+)- 10(-)

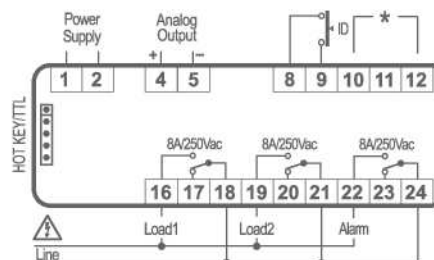

# XT100

## 2 (1 PID), 3 and 4 STAGE CONTROLLERS



C: 32x74mm



D: 4 DIN Rail

**XT141C**  
**XT141D**

Configurable digital 2 stage controllers (1 PID) with alarm relay

**XT151D**

ON/OFF configurable digital 3 stage controllers with alarm relay

**XT160D**

ON/OFF configurable digital 4 stage controllers

FEATURES	XT141C	XT141D	XT151D	XT160D
<b>Display:</b> n° digits	± 3½ d.p.	± 3½ d.p.	± 3½ d.p.	± 3½ d.p.
<b>Power supply</b>	12, 24Vac/dc 110, 230Vac	24Vac/dc 24, 110, 230Vac	24Vac/dc 24, 110, 230Vac	24Vac/dc 24, 110, 230Vac
<b>Probe inputs</b>				
NTC, PTC, Pt100, TcJ, TcK, TcS, 4÷20mA, 0÷1V, 0÷10V	config	config	config	config
<b>Relay outputs</b>				
Stage 1	8A	no 8A/nc 5A	no 8A/nc 5A	no 8A/nc 5A
Stage 2	8A	no 8A/nc 5A	no 8A/nc 5A	no 8A/nc 5A
Stage 3			no 8A/nc 5A	no 8A/nc 5A
Stage 4				no 8A/nc 5A
Alarm	8A	no 8A/nc 5A	8A	8A
<b>Other</b>				
Digital input	pres	pres	pres	pres
Hot Key/Prog Tool Kit output	pres*	pres	pres	pres
Serial output	TTL*	TTL	TTL	TTL
Analog output		4÷20mA, 0÷10V	4÷20mA, 0÷10V	4÷20mA, 0÷10V
Buzzer	opt	opt	opt	opt

\* Prog Tool Kit output and serial output only for models with 12/24Vac/dc probe supply

### XT141C

- \* 4÷20mA, 0+1V, 0+10V= 9(in); 11(gnd); 10(+)
- \* Pt100= 9 - 11(10) \* NTC, PTC= 9(in); 10(gnd)
- \* TcK, TcJ, TcS= 9(+)-11(-)

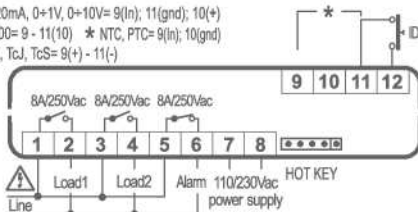

- \* 4÷20mA, 0+1V, 0+10V= 7(in); 9(gnd); 8(+)
- \* Pt100= 7 - 9(8) \* NTC, PTC= 7(in); 8(gnd)
- \* TcK, TcJ, TcS= 7(+)-9(-)

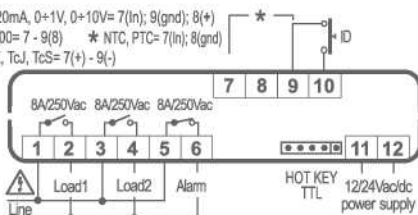

### XT141D

- \* 4÷20mA, 0+1V, 0+10V= 11(in); 10(gnd); 12(+)
- \* Pt100= 11 - 10(12) \* NTC, PTC= 11(in); 12(gnd)
- \* TcK, TcJ, TcS= 11(+)-10(-)

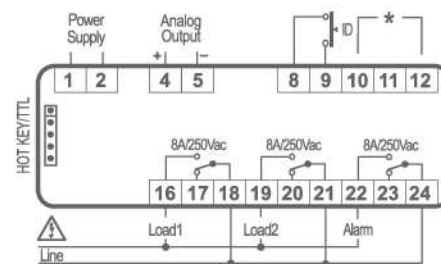

### XT151D

- \* 4÷20mA, 0+1V, 0+10V= 11(in); 10(gnd); 12(+)
- \* Pt100= 11 - 10(12) \* NTC, PTC= 11(in); 12(gnd)
- \* TcK, TcJ, TcS= 11(+)-10(-)

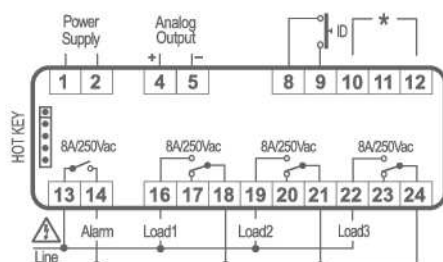

### XT160D

- \* 4÷20mA, 0+1V, 0+10V= 11(in); 10(gnd); 12(+)
- \* Pt100= 11 - 10(12) \* NTC, PTC= 11(in); 12(gnd)
- \* TcK, TcJ, TcS= 11(+)-10(-)

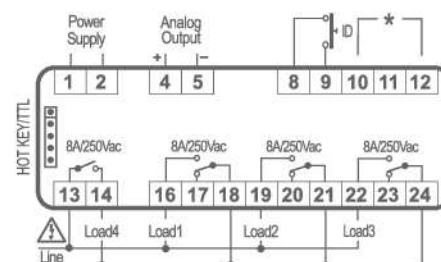





# GENERAL PURPOSE PROGRAMMABLE CONTROLLERS

## SECTION INDEX

FUNCTIONS	MODELS	
<b>XEV20 – stepper electronic expansion valve management</b>		<b>106</b>
Driver for EEV management compatible with iPro controllers	XEV20D	107
<b>iProGENIUS – general applications – high connectivity</b>		<b>108</b>
Development tool	iPro-TOOL	111
Programmable controllers with disconnectable connectors	IPG108D – IPG108E – IPG115D	112
Programmable controllers with bayonet connectors	IPG208D – IPG208E IPG215D – IPG215F	113
Expansion modules with disconnectable connectors	IPX106D – IPX115D IPX125D – IPX306D	114
Expansion modules with bayonet connectors	IPX206D – IPX215D – IPX225D	114
Connectivity module	IPL500D	115
LCD graphic display	VGIPG	116
Accessory	VISOKEY	116



D: 4 DIN Rail

## XEV20: STEPPER ELECTRONIC EXPANSION VALVE MANAGEMENT

- Driver for iPro controllers for the stepper electronic expansion valve management
- Optimization of superheat regulation inside the unit
- Increased energy savings
- Single or dual circuit
- Support for motorized valves unipolar/bipolar
- Temperature analog inputs (NTC, PTC, Pt1000)
- Pressure analog inputs (0÷5V, 4÷20mA)
- 4-position DIP Switch to set the address
- LAN output for the connection to iPro series controllers in 4 DIN format
- CANBus output for the connection to iPro series controllers in 10 DIN format
- Type of refrigerant gas: R22, R134A, R404A, R407, R410, R507

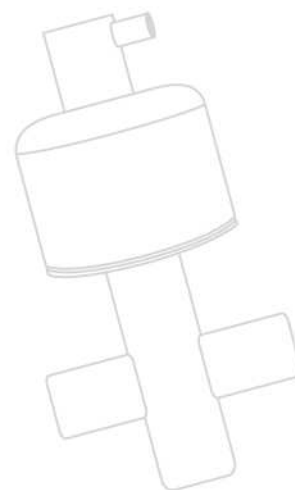

### HOW to ORDER

XEV X E V 2 0 D - 1 1 C 0 0

C

N° of valves

0 = 1 valve

1 = 2 valves

# DRIVER for EEV MANAGEMENT COMPATIBLE with iPro CONTROLLERS

# XEV20

## XEV20D

Driver for 1 or 2 unipolar and bipolar stepper electronic expansion valves to use with iPro programmable controllers



D: 4 DIN Rail

FEATURES	XEV20D
Power supply	24Vac/dc (from TF20D for 1 valve or from TF40D for 2 valves)
Probe inputs	
N°4 (Pb1, Pb2, Pb3, Pb4)	0÷5V/4÷20mA/NTC/PTC/Pt1000 config
Other	
LAN output	pres
CANBus output	pres
DIP switch for address selection	pres
Connection kit	DWXEV30

### XEV20D - 1 circuit

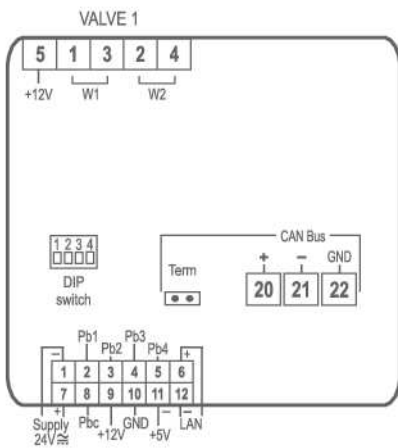

### XEV20D - 2 circuits

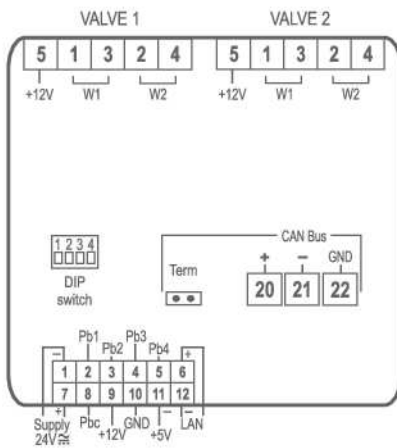



## iProGENIUS SERIES: GENERAL APPLICATIONS HIGH CONNECTIVITY

**iProGENIUS** is the Dixell family of programmable controllers that offers optimal solutions for all HVAC/R needs. They are suited for all applications in the PLC world including shopping centers, hospitals, airports, boatyards, energy management plants, and more. These controllers provide a high level of technology for ease of external connectivity and programmability providing simple answers for the user's needs, while offering local or remote monitoring control (accomplished with the powerful **iProLINK** connectivity module). An intuitive and useful HMI is also offered through the **VISOGRAPH** graphic display and the touch screen **TGIPG** display, while the expandability provided by the **IPX** modules allows use of these controllers with the most complex machinery.

- Powerful platform based on LINUX operative system on ARM9 (200MHz/32bit) microprocessor
- Internal Web Server with standard and customized Web Site
- Ethernet for connection to an intranet-internet network and to other controllers for a distributed application management
- USB output that allows the download of parameters, data/alarm log and the applications and parameters upload
- RS485 serial outputs for the connection to XWEB supervising and controlling systems or to applications developed by third Party Systems
- BACnet® communications allows the system to have easy and immediate integration with different manufactures ensuring complete interoperability
- Connection to the expansion modules to increase system capacity
- Connection to the driver for the management and control of electronic expansion valves

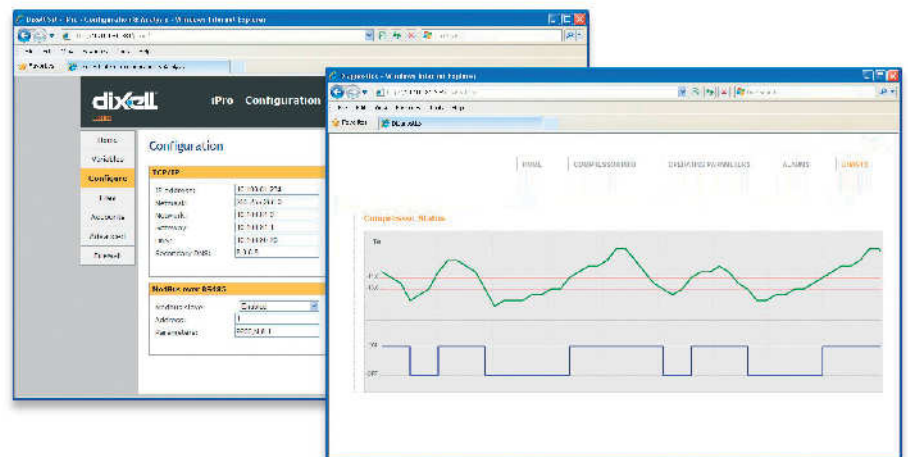

## MAIN FEATURES

- CPU: 200MHz
- Processor 32bit
- RAM memory: 32MB (4 DIN Rail)  
64MB (10 DIN Rail)
- Data storing on Flash memory: 32MB (4 DIN Rail)  
128MB (10 DIN Rail, IPL500D)
- Power absorption: 40VA max (IPG on 4 DIN Rail)  
20VA max (IPG and IPX on 10 DIN Rail, IPL500D)  
10VA max (IPX on 4 DIN Rail)

## HOW to ORDER

IPRO-TOOL 

I	P	R	O	-	T	O	O	L	-	O	O	O	O	E
---	---	---	---	---	---	---	---	---	---	---	---	---	---	---

**E**

### Visoprogram

- 0 = No  
1 = 2 licences

IPG108D/E – IPG208D/E 

I	P	G		0	8	-	1	0	C	D	0
---	---	---	--	---	---	---	---	---	---	---	---

IPG115D – IPG215D/F 

I	P	G		1	5	-	A	B	C	0	0
---	---	---	--	---	---	---	---	---	---	---	---

**A**

**B**

**C**

**D**

Power supply	Modem	Ethernet, protocols	Serial port
1 = 24Vac/dc <b>UL versions</b> 2 = 24Vac 3 = 24Vdc (for IPG215)	0 = No 1 = Internal modem (not for UL) 2 = External modem 3 = External + internal modem (not for UL)	0 = No 1 = Yes (for IPG115D, IPG215D and IPG215F) 2 = BACnet	1 = LAN 2 = RS485 master

IPX106D 

I	P	X	1	0	6	D	-	1	0	0	0	0
---	---	---	---	---	---	---	---	---	---	---	---	---

IPX206D – IPX306D 

I	P	X		0	6	D	-	1	0	0	0	E
---	---	---	--	---	---	---	---	---	---	---	---	---

IPX115D – IPX215D 

I	P	X		1	5	D	-	1	0	0	0	0
---	---	---	--	---	---	---	---	---	---	---	---	---

IPX125D – IPX225D 

I	P	X		2	5	D	-	1	0	0	0	2
---	---	---	--	---	---	---	---	---	---	---	---	---

**E**

### N° of SSR relay

- 0 = 0  
2 = 1

IPL500D 

I	P	L	5	0	0	D	-	1	B	C	D	0
---	---	---	---	---	---	---	---	---	---	---	---	---

**B**

**C**

**D**

Modem	Ethernet, protocols	Serial port
0 = No 1 = Internal modem GPRS	1 = Yes 2 = BACnet	1 = LAN 2 = RS485 master

VGIPG 

V	G	I	P	G	-	A	B	0	D	0
---	---	---	---	---	---	---	---	---	---	---

**A**

**B**

**D**

Buzzer	Kind of mounting	Coding
0 = No 1 = Yes	P = Panel W = Wall	0 = Ascii 1 = Unicode

## CONNECTIVITY

The high degree of connectivity that marks iProGENIUS controllers, ensures a complete local and remote unit/plant management.

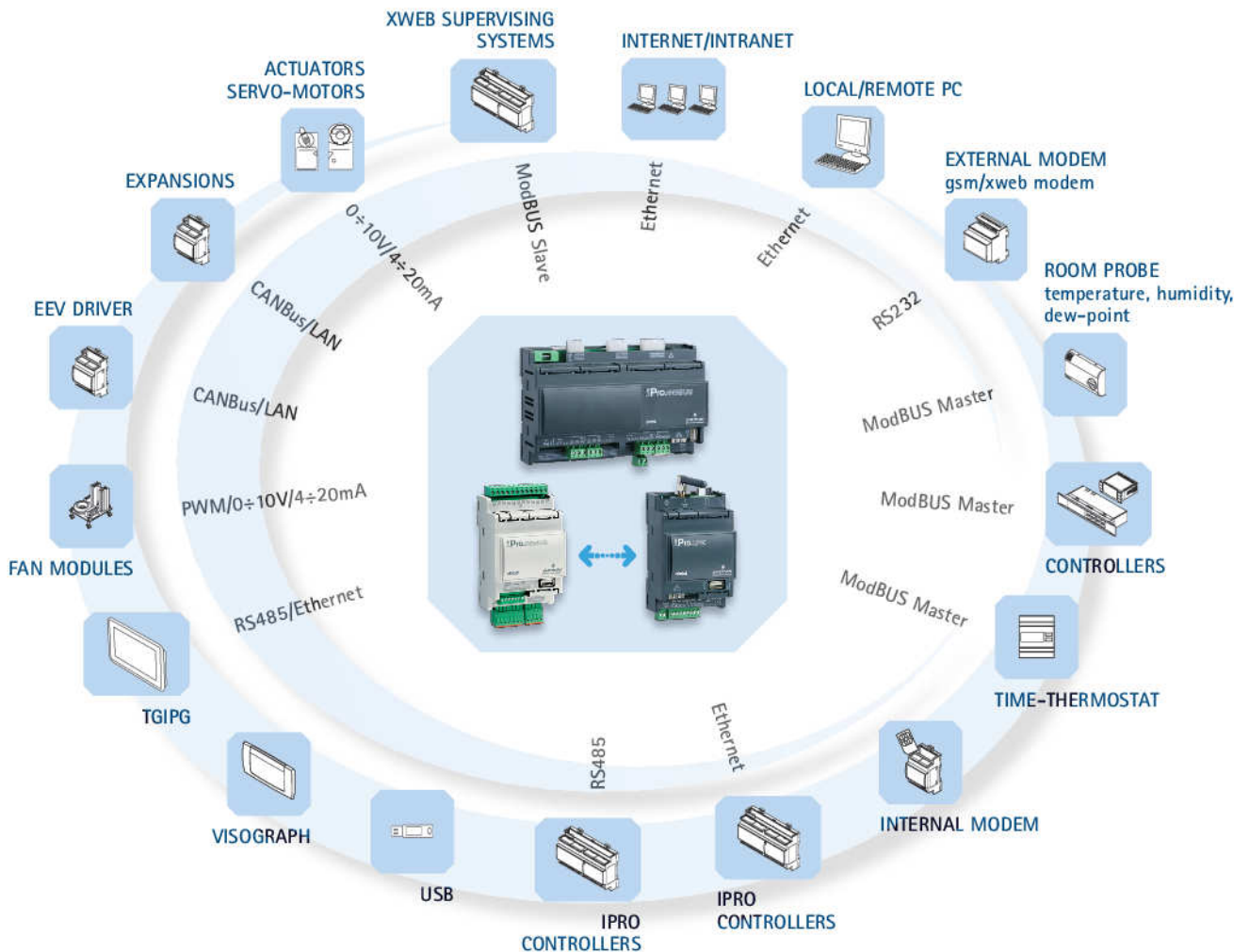
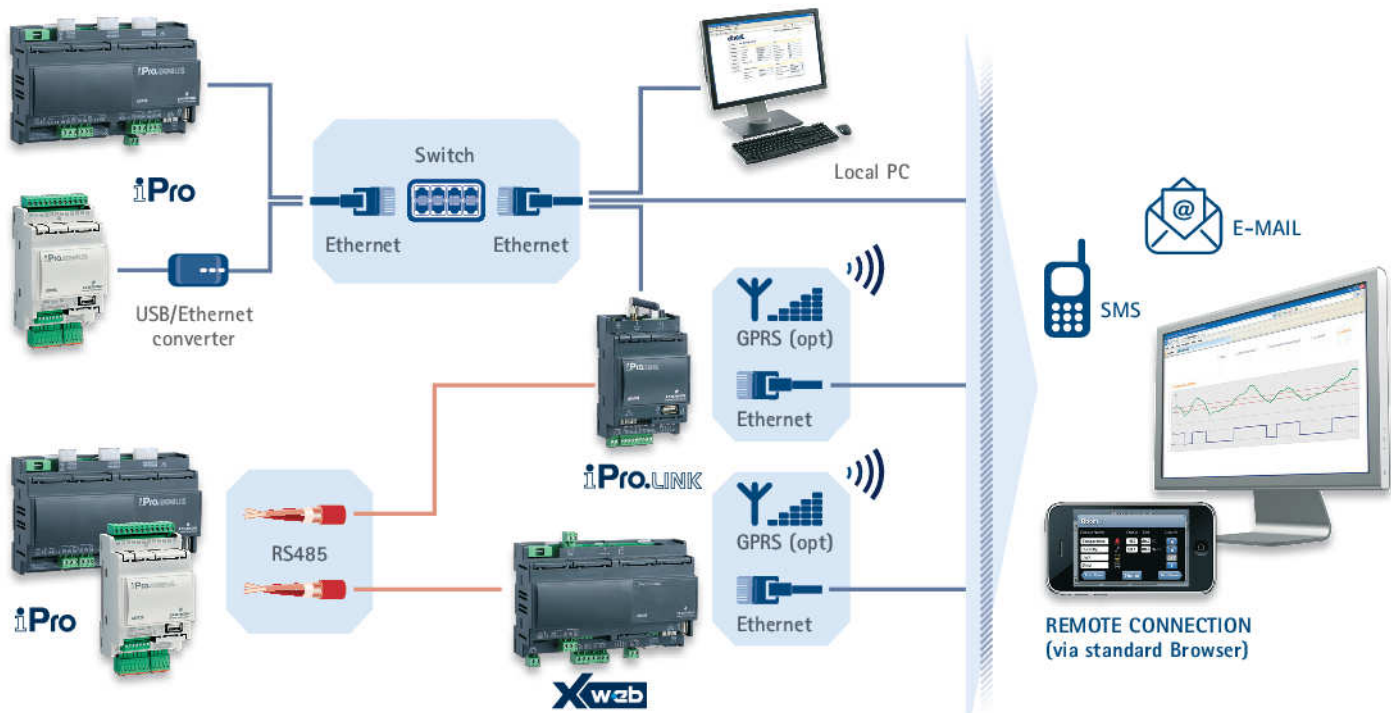

- 1 ISaGRAF® + WIZMATE
- 2 ISaGRAF® + WIZMATE + VISOPROG

iPro-TOOL is a complete and easy to use tool that allows the user to work independently to create programs for iPro controllers, taking advantage of all the programmable series potential. The package includes manuals and the **ISaGRAF®**, **WIZMATE** and **VISOPROG** (optional) software.

The user can choose among 2 options listed above.

Note: Wizmate can be used with iProRACK applications.

## ISaGRAF®

ISaGRAF® is the standard, international and complete development environment selected by Dixell to create programs that will be uploaded into the iPro series. Also ideal for small applications, it can manage several I/O points, allows users to create control systems, and is supported all over the world. ISaGRAF® offers a combination of a highly portable, robust management engines (Virtual Machine) and an intuitive application development environment (Workbench). ISaGRAF® integrates the best system for simulation and remote debugging, supports the Flow Chart (FC: Flow Chart) and 5 different programming languages coded according to IEC61131 (SFC: Sequential Function Chart; ST: Structured Text; FBD: Function Block Diagram; IL: Instruction List; LD: Ladder Diagram).

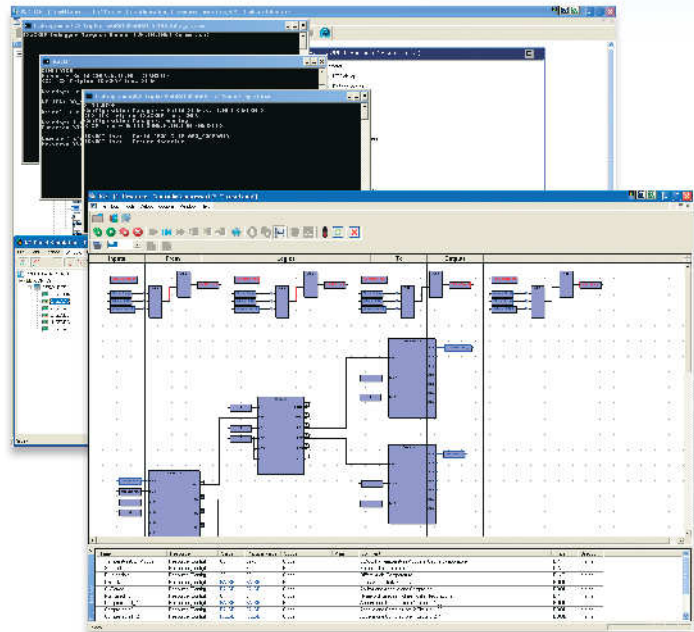

## WIZMATE

WIZMATE is versatile software that has a fast and easy programming mode for iPro controllers (ideal for versions with the application included like the iProRACK).

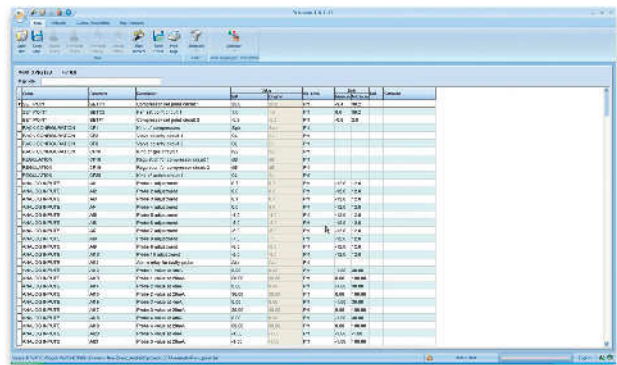

## VISOPROG

The VISOPROG is a tool that allows users to create the VISOGRAPH keyboard graphic interfaces. The program, installed on a PC, is connected to ISaGRAF® project and has a basic interface that users can easily customize depending on the requirements.

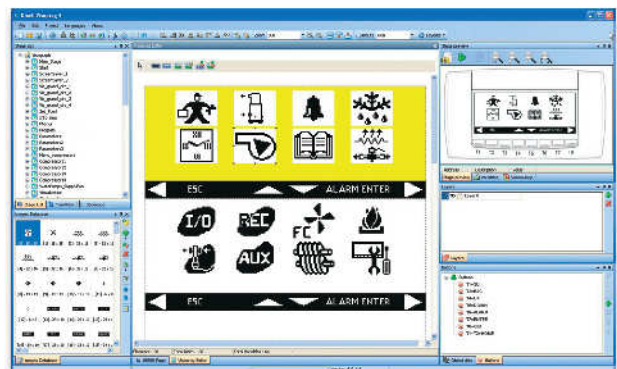



D, E: 4 DIN Rail



D: 10 DIN Rail

<b>IPG108D</b>	Programmable controller in 4 DIN Rail format with disconnectable + screw connectors
<b>IPG108E</b>	Programmable controller in 4 DIN Rail format with LED display and disconnectable + screw connectors
<b>IPG115D</b>	Programmable controller in 10 DIN Rail format with disconnectable connectors

FEATURES	IPG108D	IPG108E	IPG115D
<b>Display</b>		dual with icons	
<b>Front led</b>			
<b>Power supply</b>	24Vac/dc from TF40D	24Vac/dc from TF40D	24Vac/dc from TF20D
<b>Probe inputs</b>			
0÷1V, 0÷5V, 0÷10V, 0÷20mA, 4÷20mA, NTC, PTC, DI	6 x config	6 x config	10 x config
<b>Digital inputs</b>			
Optoinsulated	11 x config	11 x config	20 x config
<b>Relay outputs</b>			
Configurable	8 x 5A	8 x 5A	12 x 5A + 3 x 8A
<b>Other outputs</b>			
PWM	4 x config	4 x config	2 x config
0÷10V/4÷20mA			
0÷10V			
RS485	slave	slave	master + slave
USB	pres	pres	pres
External modem			GSM, analogue
LAN/RS485 master	pres	pres	
CANBus			
Ethernet	via USB-ETH-CONV	via USB-ETH-COM	pres opt
<b>Other</b>			
Remote keyboard	1 x VGIPG	1 x GIPG	2 x VGIPG
Internal modem			analogue opt
Real time clock	pres	pres	pres
Flash memory	32MB	32MB	128MB
Connections	disconnectable + screw	disconnectable + screw	disconnectable
Connection kit	DWS30-KIT, IP-FC108	DWS30-KIT, IP-FC108	DWB30-KIT
Expansion modules	IPX115D, IPX125D, IPX306D	IPX115D, IPX125D, IPX306D	IPX106D, IPX115D, IPX125D
BACnet protocol	opt	opt	opt

### IPG108D - IPG108E

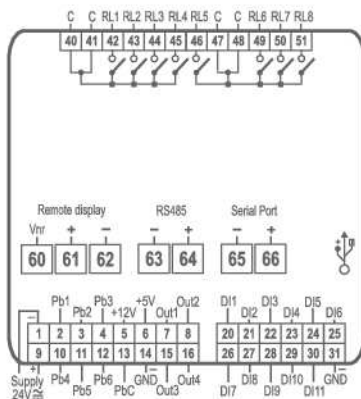

### IPG115D

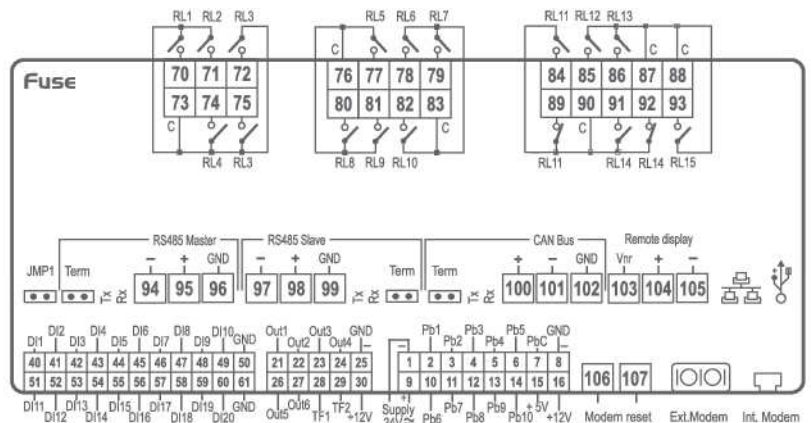



# PROGRAMMABLE CONTROLLERS with BAYONET CONNECTORS

# iProGENIUS

<b>IPG208D</b>	Programmable controller in 4 DIN Rail format with bayonet + screw connectors, ideal for the civil field
<b>IPG208E</b>	Programmable controller in 4 DIN Rail format with LED display and bayonet + screw connectors, ideal for the civil field
<b>IPG215D</b>	Programmable controller in 10 DIN Rail format with bayonet + screw connectors, ideal for the civil field
<b>IPG215F</b>	Programmable controller in 10 DIN Rail format with front LED and bayonet + screw connectors, ideal for the civil field



D, E: 4 DIN Rail

D, F: 10 DIN Rail

FEATURES	IPG208D	IPG208E	IPG215D	IPG215F
<b>Display</b>		dual with icons		n° 5
<b>Front led</b>				
<b>Power supply</b>	24Vac/dc from TF40D	24Vac/dc from TF40D	24Vac/dc from TF20D	24Vac/dc from TF20D
<b>Probe inputs</b>				
0÷1V, 0÷5V, 0÷10V, 0÷20mA, 4÷20mA, NTC, PTC, DI	6 x config	6 x config	10 x config	10 x config
<b>Digital inputs</b>				
Optoinsulated	11 x config	11 x config	20 x config	20 x config
<b>Relay outputs</b>				
Configurable	8 x 5A	8 x 5A	15 x 5A	15 x 5A
<b>Other outputs</b>				
PWM				
0÷10V/4÷20mA	4 x config	4 x config	2 x config	2 x config
0÷10V			4	4
RS485	slave	slave	master + slave	master + slave
USB	pres	pres	pres	pres
External modem			GSM, analogue	GSM, analogue
LAN/RS485 master	pres	pres		
CANBus			pres	pres
Ethernet	via USB-ETH-CONV	via USB-ETH-CONV	pres opt	pres opt
<b>Other</b>				
Remote keyboard	1 x VGIPG	1 x VGIPG	2 x VGIPG	2 x VGIPG
Internal modem			analogue opt	analogue opt
Real time clock	pres	pres	pres	pres
Flash memory	32MB	32MB	128MB	128MB
Connections	bayonet + screw	bayonet + screw	bayonet + screw	bayonet + screw
Connection kit	IP-FC208	IP-FC208	IP-FC215CP	IP-FC215CP
Expansion modules	IPX206D, IPX215D, IPX225D	IPX206D, IPX215D, IPX225D	IPX206D, IPX215D, IPX225D	IPX206D, IPX215D, IPX225D
BACnet protocol	opt	opt	opt	opt

## IPG208D - IPG208E

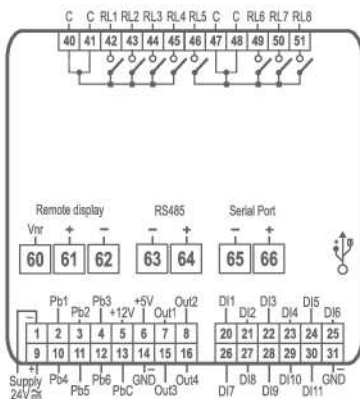

## IPG215D - IPG215F

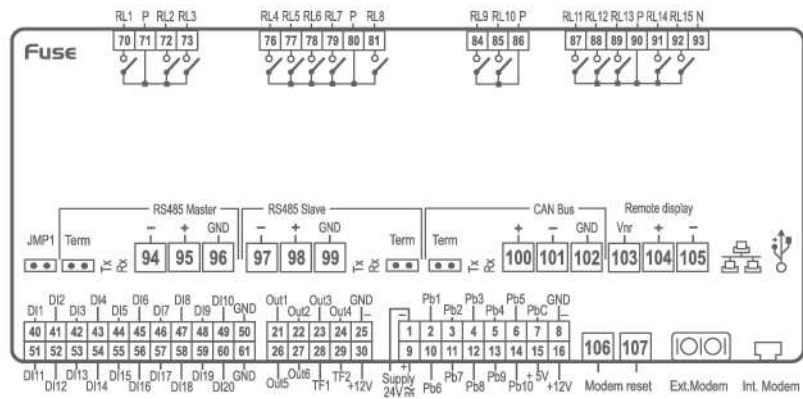



D: 4 DIN Rail    D: 4 DIN Rail    D: 4 DIN Rail



D: 10 DIN Rail    D: 10 DIN Rail

<b>IPX106D</b>	Expansion module in 4 DIN Rail format with disconnectable connectors and 6 relay outputs
<b>IPX115D</b>	Expansion module in 10 DIN Rail format with disconnectable connectors and 15 relay outputs
<b>IPX125D</b>	Expansion module in 10 DIN Rail format with disconnectable connectors and 25 relay outputs
<b>IPX206D</b>	Expansion module in 4 DIN Rail format with bayonet + screw connectors and 6 relay outputs
<b>IPX215D</b>	Expansion module in 10 DIN Rail format with bayonet + screw connectors and 15 relay outputs
<b>IPX225D</b>	Expansion module in 10 DIN Rail format with bayonet + screw connectors and 25 relay outputs
<b>IPX306D</b>	Expansion module in 4 DIN Rail format with disconnectable + screw connectors and 6 relay outputs

FEATURES	IPX106D	IPX115D	IPX125D	IPX206D	IPX215D	IPX225D	IPX306D
<b>Power supply</b>	24Vac/dc from TF10D	24Vac/dc from TF20D	24Vac/dc from TF20D	24Vac/dc from TF10D	24Vac/dc from TF20D	24Vac/dc from TF20D	24Vac/dc from TF10D
<b>Probe inputs</b>							
0÷1V, 0÷5V, 0÷10V, 0÷20mA, 4÷20mA, NTC, PTC, DI	7 x config	10 x config	10 x config	7 x config	10 x config	10 x config	7 x config
<b>Digital inputs</b>							
Optoinsulated	3 x config	20 x config	20 x config	3 x config	20 x config	20 x config	3 x config
<b>Relay outputs</b>							
Configurable	6 x 5A	12 x 5A + 3 x 8A	18 x 5A + 3 x 8A + 4 x SSR	5 x 5A + 1 x 8A or 4 x 5A + 1 x 8A + 1 x SSR	15 x 5A	21 x 5A + 4 x SSR	5 x 5A + 1 x 8A or 4 x 5A + 1 x 8A + 1 x SSR
<b>Other outputs</b>							
0÷10V/4÷20mA		2 x config	2 x config		2 x config	2 x config	
0÷10V	3	4	4	3	4	4	3
LAN	pres	pres	pres	pres	pres	pres	pres
CANBus							
<b>Other</b>							
Dip switch for address set	pres	pres	pres	pres	pres	pres	pres
Connections	disconnectable	disconnectable	disconnectable	bayonet + screw	bayonet + screw	bayonet + screw	disconnectable + screw
Connection kit	DWEX60-30KIT	DWX115-30KIT	DWEX70-30KIT	IP-FCEX60	IP-FCX215	IP-FCEX70	DWEX306-30KIT

### IPX106D - IPX206D - IPX306D

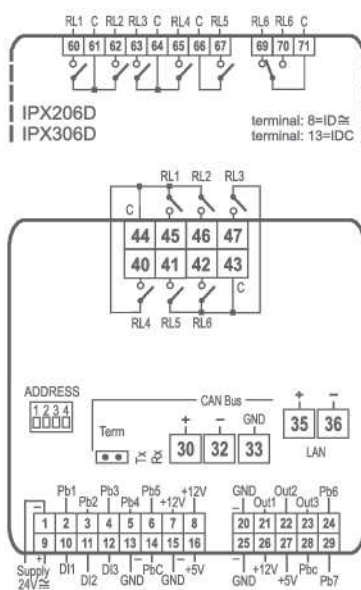

### IPX115D - IPX125D - IPX215D - IPX225D

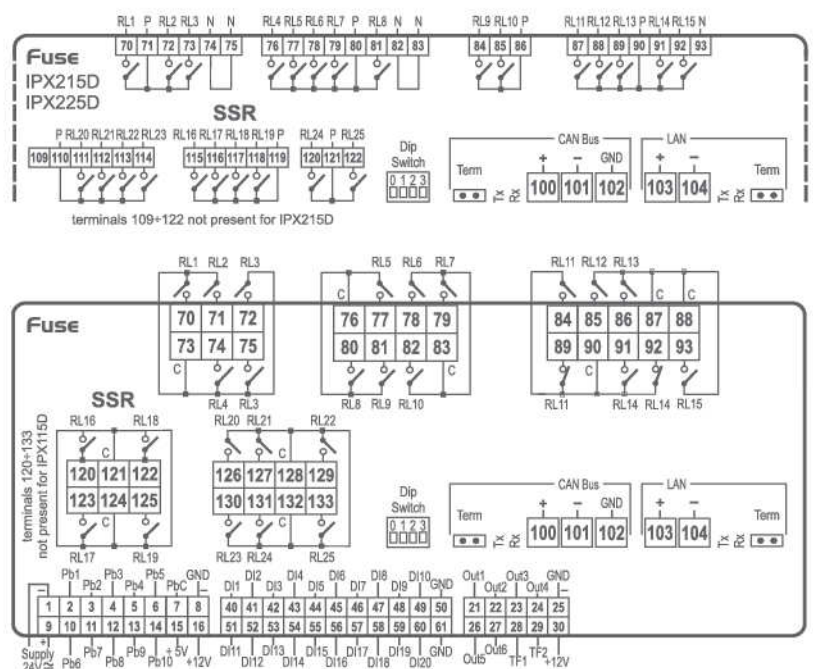

## IPL500D

Programmable connectivity module designed to collect, store, process, and manage data. It is compatible with the iPro controllers and allows downloading of applications for data processing or management of other integrated devices



D: 4 DIN Rail

FEATURES	IPL500D
<b>Power supply</b>	24Vac/dc from TF20D
<b>Outputs</b>	
RS485	slave
USB	pres
LAN/RS485 master	pres
CANBus	pres
Ethernet	pres
<b>Other</b>	
Remote keyboard	VGIPG
Internal modem	GPRS opt
Real time clock	pres
Flash memory	128MB
Connections	screw
Connection kit	IP-FC500
BACnet protocol	opt

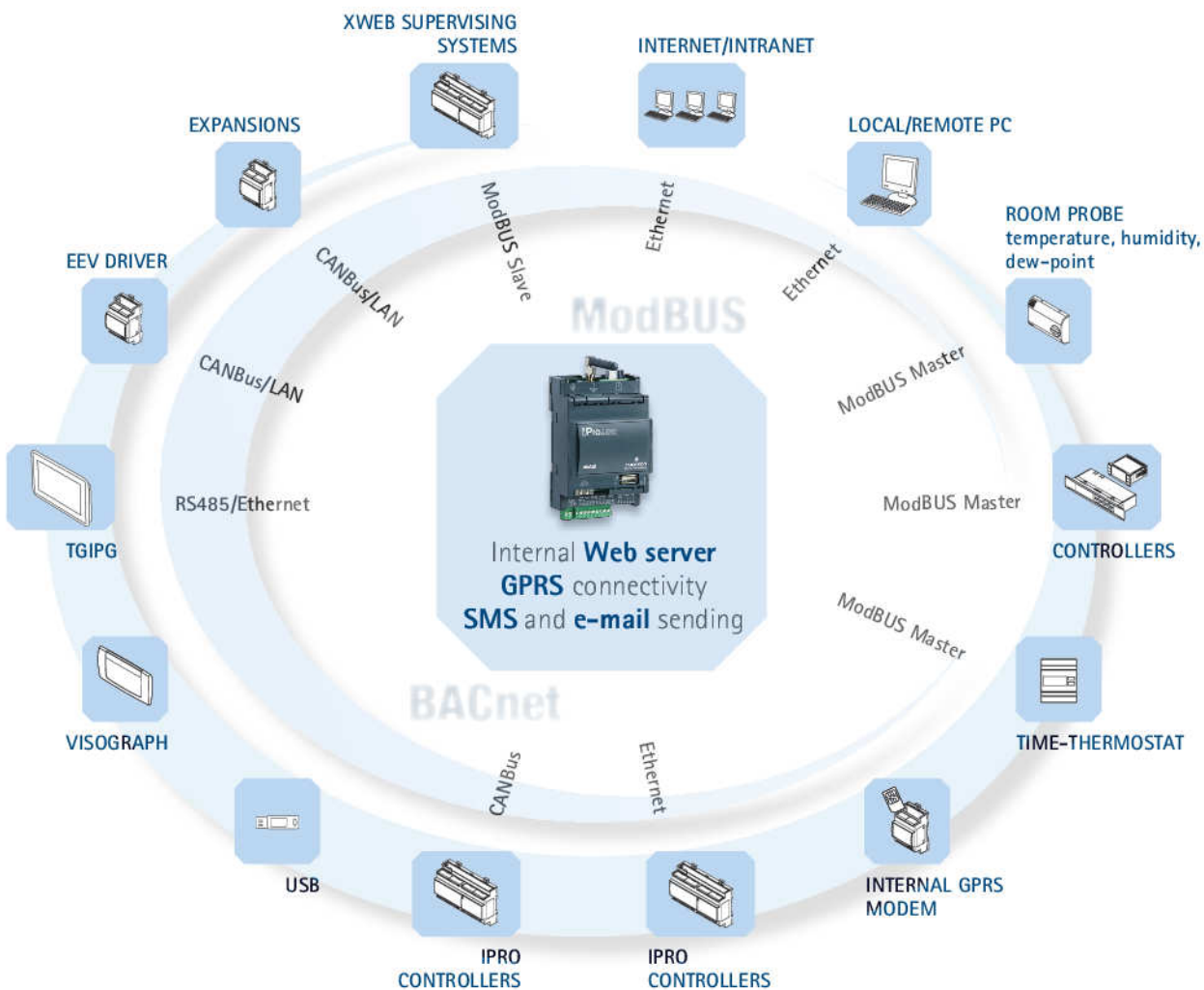
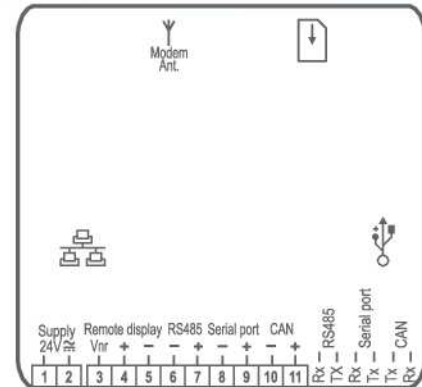

# VISOGRAPH

## LCD GRAPHIC DISPLAY



VG: 82x156mm

### VGIPG

Graphic display fully programmable (via VISOPROG or through USB from the iPro) for iProGENIUS controllers with LCD graphic display with 240x96pixels

FEATURES	VGIPG
Power supply	from controller
Visokey output	pres
Buzzer	opt

- Great versatility and extensive customization opportunities
- Complete integration with ISaGRAF® projects
- UNICODE character compatible
- Quick panel or wall mounting
- Up to 2 keyboards connectable with iPro controllers
- Maximum distance from the controller: 150m

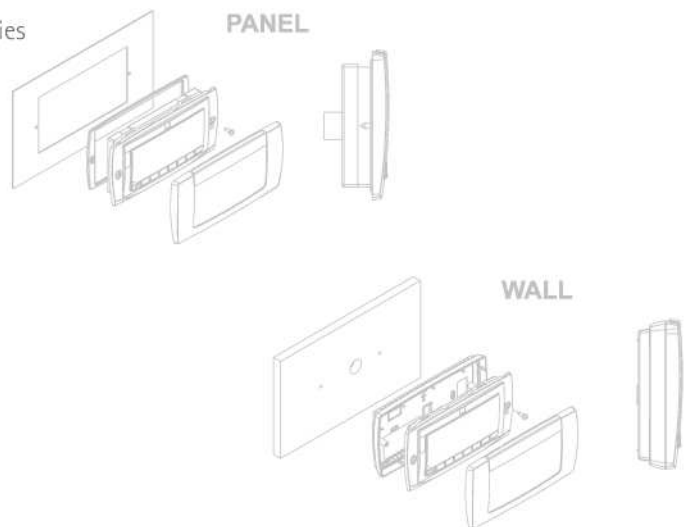

### VISOPROG

VISOPROG allows the creation of graphic interfaces for VISOGRAPH keyboards, VGIPG model. The program installed on a PC is connected to the ISaGRAF® project with a basic interface that can be easily customized based on the user's needs. VISOPROG allows a direct transfer of the user interface from PC to a keyboard. The image on the right shows an operative VISOPROG screen with the relative VISOGRAPH final interface

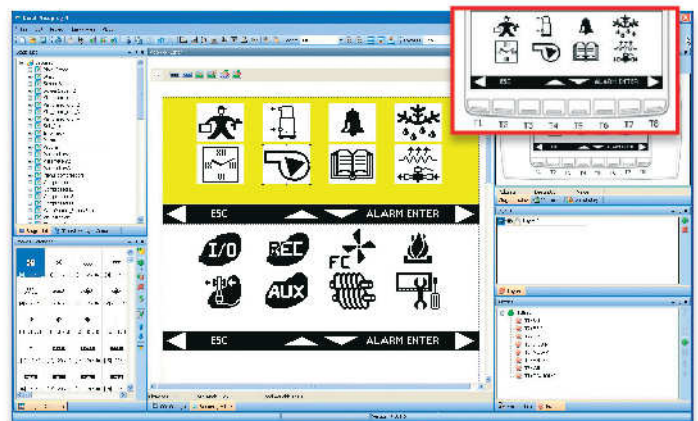

### ACCESSORY

#### VISOKEY

Programming kit for Visograph keyboards





# GENERAL PURPOSE TOUCH SCREEN DISPLAYS

## SECTION INDEX

FUNCTIONS	MODELS	
<b>TGIPG – high programmability</b>		<b>118</b>
Programmable touch screen displays	TGIPG	120
Accessories	TF-TGIPG – CAB/485-TGIPG CAB/WEB/PC	120



TGIPG: 228x280mm

10,4"

TGIPG: 143x204mm

7"

TGIPG: 104x145mm

4,3"

## TGIPG SERIES: HIGH PROGRAMMABILITY

To make easier, more intuitive and complete communication with their controllers, Dixell introduces the innovative family (TGIPG) of TFT touch screen displays, characterized by its aesthetic value and fast Ethernet/Internet connectivity.

The versatile and compact line, exceptional hardware performances, advanced functionalities, and a large number of symbols and templates makes the TGIPG family the perfect solution for HVAC/R needs. The easy programming mode and the use of a graphic editor make the creation of a user interface quick and easy.

- Powerful platform based on ARM9 (400MHz) microprocessor, RAM memory 64MB (DDR2), data storing on FLASH memory 128MB SSD and on external card SD
- Connection with Dixell controllers via RS485 or Ethernet
- Remote connection (via Internet)
- USB for mouse, printer and application update
- TFT-LCD display - 16.7 million colors (true color), LED backlight
- Solid and elegant silver housing
- IP65 front protection
- Advanced graphic (vector) features
- Ability to create a fast, custom synoptic overview of the unit
- Complete alarm management
- Built in data logger
- Runtime graphics
- Multilanguage management with automatic translation via Internet
- Simulation mode to check applications on PC
- 1A max power absorption

### HOW to ORDER

TGIPG    T   G   I   P   G   -   A   0   0   0   0

A

#### Version

- 0 = 4,3"
- 2 = 7"
- 3 = 10,4"

## CONNECTIVITY

Touch screen displays of the TGIPG line with multiple ports, are characterized by high connectivity both local and remote to satisfy every application need.

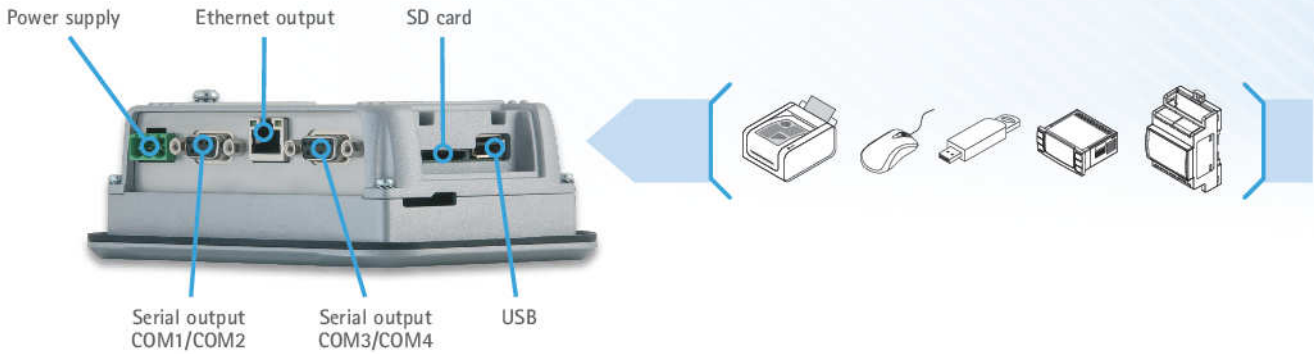

### LOCAL

### REMOTE



## SOFTWARE

The TGIPG family is characterized by quick and easy graphic editor that allows for faster creation of applications. The integrated guideline functions, with its large number of symbols and templates, combined with the ability to manage high resolution images allows complex interfaces to be easily created while at the same time being complete, intuitive, and appealing. Effective language management through a dedicated menu and automatic translation via the Internet are among the many strengths of the touch screen line. Below is an example of a "final screen" and an example of a "variables configuration window".

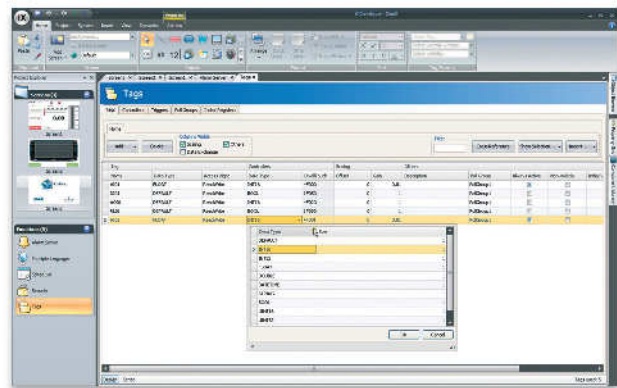
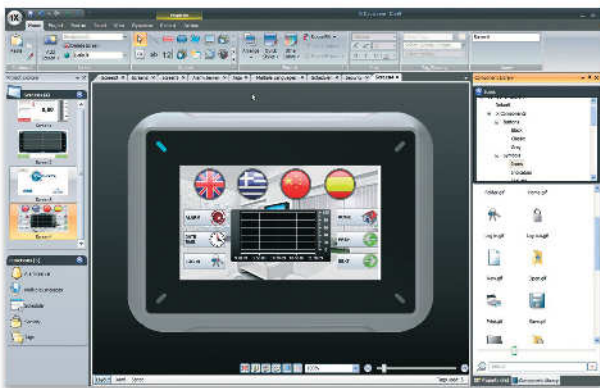



TGIPG: 228x280mm



TGIPG: 143x204mm



TGIPG: 104x145mm

**TGIPG** | Programmable TFT touch screen displays

FEATURES	TGIPG v. 4,3"	TGIPG v. 7"	TGIPG v. 10,4"
Power supply	24Vdc	24Vdc	24Vdc
Format	16:9	16:9	4:3
Display	480x272pixels	800x480pixels	640x480pixels
Ethernet output	pres	pres	pres
Serial output	2 x RS485/232/422	2 x RS485/232/422	2 x RS485/232/422
USB output	pres	pres	pres
Buzzer (beeps when pressed)	pres	pres	pres
Real time clock	pres	pres	pres

### ACCESSORIES

#### TF-TGIPG

Power supply 24Vdc/1A for TGIPG



#### CAB/485-TGIPG

Cable for RS485 connection with connector for TGIPG



#### CAB/WEB/PC

Ethernet patch cross over cable, 1m







# SYSTEMS

## SECTION INDEX

FUNCTIONS	MODELS	
<b>GLOBAL RETAIL SOLUTION</b>		<b>122</b>
<b>XWEB300D - alarm management and controlling</b>		<b>124</b>
Alarm and controlling web server	XWEB300D	124
<b>XWEB500 - XWEB500D - monitoring and controlling</b>		<b>126</b>
Monitoring and controlling web server	XWEB500 - XWEB500D	126
<b>XWEB3000 - industrial monitoring and controlling</b>		<b>128</b>
Industrial monitoring and controlling web server	XWEB3000	128
<b>XWEB5000 - monitoring, controlling and supervising</b>		<b>130</b>
Monitoring, controlling and supervising web server	XWEB5000	130
<b>XWEB FUNCTIONS</b>		<b>132</b>
<b>XWEB CONNECTIONS</b>		<b>134</b>
<b>XWEB SYSTEM GUIDE</b>		<b>136</b>
<b>iCOOLL - wireless solution</b>		<b>137</b>
TX/RX modules for wireless network	XJ200	137
Accessory	PW200J	137
<b>XJM - I/O management</b>		<b>138</b>
Multifunction module for inputs and outputs	XJM60D	139
Keyboard for XJM controller	VJM60	139
<b>XJA-XJP-XJR - relay and acquisition management</b>		<b>140</b>
Alarm/status acquisition modules	XJA50D - XJA50SL	141
Probe and alarm data acquisition modules	XJP30D - XJP40D - XJP60D	141
Relay module	XJR40D	141
Keyboard for XJA-XJP-XJR controllers	KB1 PRG	141
Accessory	CAB/KB11	141
<b>XCENTER - centralized management</b>		<b>142</b>
Centralized management software for Call Center	XCENTER	142

# GLOBAL RETAIL SOLUTION

Research, great experience, regulation and design innovation: these are the elements that allow Dixell to offer controllers and supervising systems that are in the forefront for all refrigeration applications, cooking and air conditioning fields. A series of specific solutions and a comprehensive range that extends from Thermometers to Multifunction Controllers, from Supervising Systems to the Call Centers, for a completely centralized plant.

In particular, Dixell's systems are a range designed to satisfy all quality, user friendliness and efficiency requirements for every kind of application.

Dixell, with its systems, integrates and coordinates all components of system regulation in order to optimize the efficiency and to increase energy savings.

## APPLICATIONS

PETROL STATIONS  
STORAGE CENTRES



SUPERMARKETS  
HYPERMARKETS



PRODUCTION PLANTS  
INDUSTRIES



### ENERGY SAVING



ModBUS



iCOOLL XJ200



Some of Dixell's instruments that allow this are:

- the innovative suction pressure management of compressor rack's through CRO
- the dew point check and the modular management of anti-sweat heaters
- the load supervising and the electric consumption peak management

In addition the typical functions of a monitoring system:

- the temperature recording according to HACCP regulations
- the transmission and management of regulation and plant alarms

Results prove that Dixell systems are in synergy with all regulation components ensuring:

- better performance
- greater efficiency
- a complete local and remote monitoring
- maximum environmental preservation

XCENTER, the centralized management software ideally suited for a modern and organized Call Center, completes the range of products. A powerful and affordable instrument that allows a remote plant monitoring.

## SYSTEMS



XWEB5000



XWEB3000



XWEB500 - XWEB500D



XWEB300D



## CALL CENTER



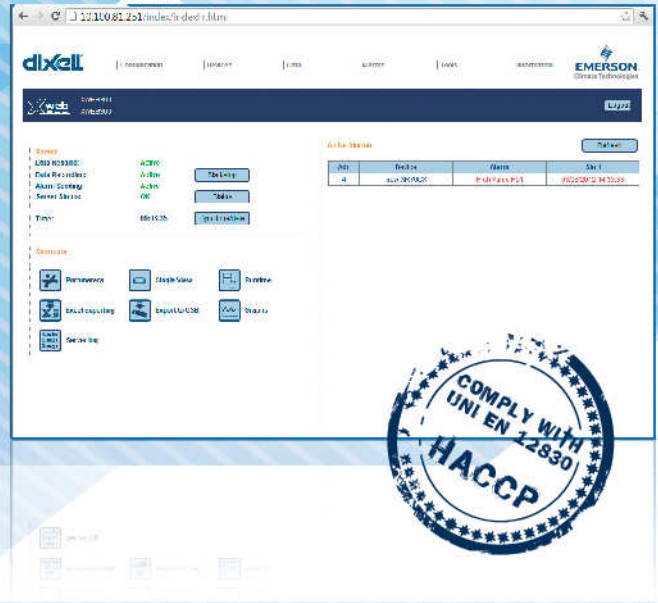

## XWEB300D: ALARM MANAGEMENT and CONTROLLING

It is extremely well suited for 6 or 18 device installations such as petrol stations, mini-market, small storage centres. A simple DIN Rail mounting (4 DIN) and the absence of local user interface make the XWEB300 the ideal solution for the remote assistance (via modem) to the plant. Local or remote connection from PC is made without the need for special software, only standard web browser (Microsoft Internet Explorer® or Firefox®) software is needed; the information is displayed as Web pages. The competitive price lets you to use this Web Server in applications with a only a single regulator such as compressor rack and medical close control.

- Data capture and alarm monitoring WEB server connectable to Dixell's controllers with serial output or to others ModBUS-RTU compatible devices
- XWEB is a 10DIN Rail module for easy DIN Rail mounting (DIN) directly inside the machine board or wall mounting with brackets
- Quick and easy connection to Web pages with dedicated interface for PDA/Smartphone
- Possibility to see and modify the parameters of the connected devices remotely
- Complete and simplified analysis of the unit functioning thanks to a powerful tool that allows viewing data in graphical format (Excel®)
- One year of stored data inside the XWEB memory (one year of stored data with 15min sampling time for 6 or 18 controllers)
- XWEB is always accessible even with isolated installations using the built-in GPRS connectivity (optional)
- Access to customized functions
- Data export on USB pendrive
- Alarm sending via FAX, SMS or e-mail
- 15VA max power absorption

### HOW to ORDER

XWEB300D    X   W   E   B   3   0   0   D   -   A   B   0   0   E

A	B	E
<b>Power supply</b>	<b>N° of instruments</b>	<b>Internal modem</b>
2 = 24Vac	B = 6	0 = No
8 = 110÷230Vac	F = 18	1 = Analogue
		2 = GSM/GPRS

XWEB300D checks the unit and, in case of malfunction alarm, it notifies the assistance center through FAX, SMS or e-mail. It allows OEM's via direct control to decide to engage a local service call out only if necessary. XWEB300D can also record all data relevant to the function of the controlled unit and insert them into a table. In this way the OEM has important information for new models for improvement of the unit itself.

Thanks to LAN port, the connection (also via internet) to the XWEB300D is easy and safe and no special software is required. It is possible to see all the variables of a controller and to manage of all parameters and alarms. With Java Applet it is possible to generate comprehensive visual graphs.



## FEATURES

## XWEB300D

Power supply	24, 110÷230Vac
LAN output	pres
USB output	pres
RS485 output	pres
Relay output	1 config
Sampling time	from 1 to 60 minutes
External modem	analogue or GSM
Internal modem	analogue or GSM/GPRS opt

## HARDWARE

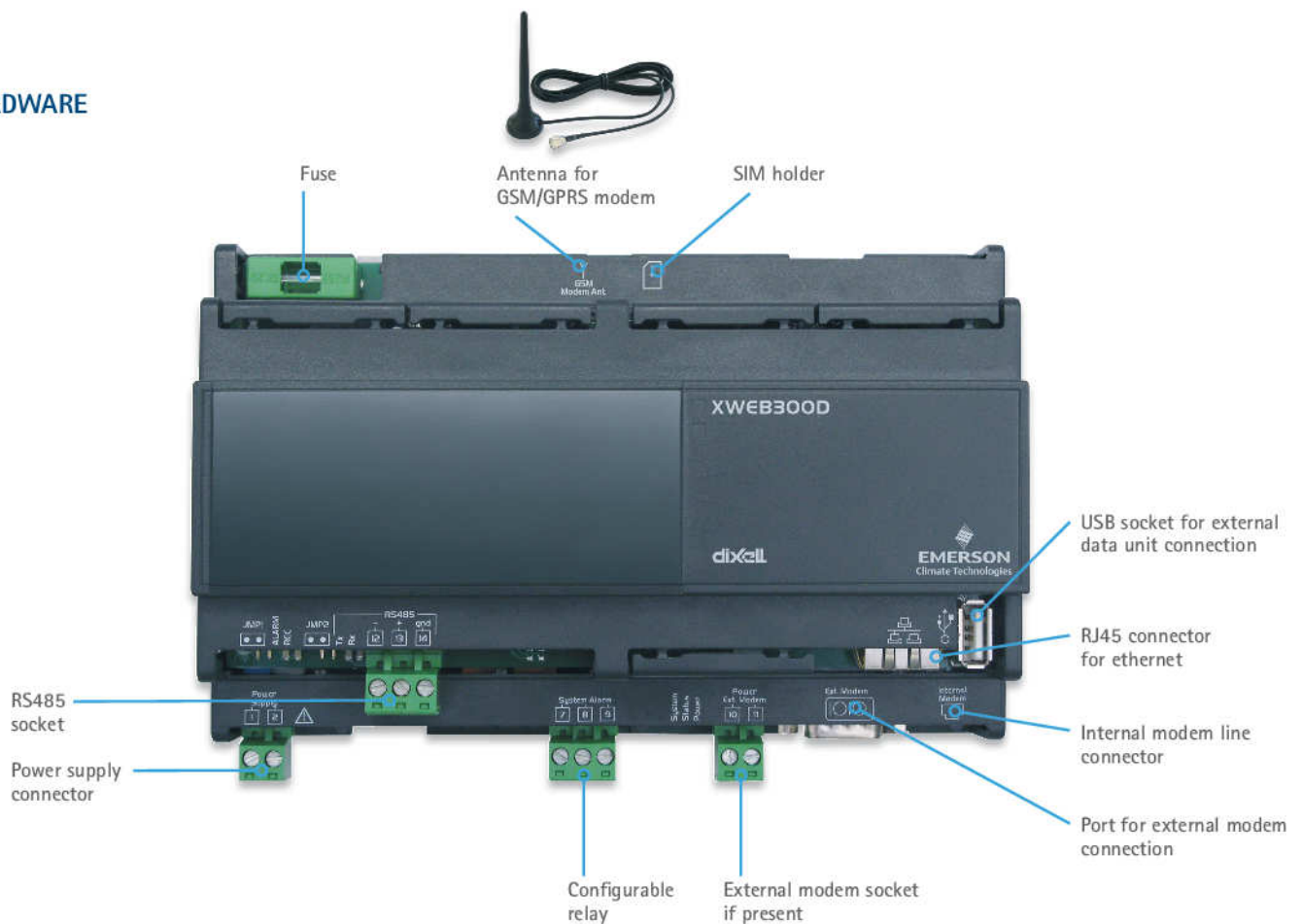



## XWEB500–XWEB500D: MONITORING and CONTROLLING

It is extremely well suited for medium installations up to 36 or 100 devices, such as petrol stations, supermarkets or storage centers. Its innovative and useful features make the instrument suitable for medium-large applications such as production and storage goods centers. Thanks to its two available formats, it can be installed whether on DIN Rail or wall or panel mounting, but can also be used as desk instrument. Local or remote connection from a PC is made without the need of special software, only a standard web browser (Microsoft Internet Explorer® or Firefox®) software is needed; the information is displayed as Web pages.

- Data capture and alarm monitoring WEB server connectable to Dixell's controllers with serial output or to others ModBUS-RTU compatible devices
- Ability to operate in stand alone mode thanks to the local display and keyboard (XWEB500)
- Easy DIN Rail mounting (DIN) directly inside the machine board or wall mounting with brackets (XWEB500D)
- Quick and easy connection to Web pages with dedicated interface for PDA/Smartphone
- Possibility to see and modify the parameters of the connected devices remotely
- Complete and simplified analysis of the unit functioning thanks to a powerful tool that allows to view data in graphical format (Excel®)
- One year of stored data inside the XWEB memory (one year of stored data with 15min sampling time for 36 or 100 controllers)
- XWEB500D is always accessible even with isolated installations using the built-in GPRS connectivity (optional)
- Layout for netsurfing of web site in graphic format
- Data export on USB pendrive
- Performance Meter for cooling demand control
- Alarm sending via FAX, SMS or e-mail
- 15VA max power absorption for XWEB500D and 20VA max for XWEB500

### HOW to ORDER

XWEB500    X W E B 5 0 0 - A B 0 0 E  
 XWEB500D    X W E B 5 0 0 D - A B 0 0 E

A	B	E
<b>Power supply</b>	<b>N° of instruments/CRO</b>	<b>Internal modem</b>
2 = 24Vac (for XWEB500D)	H = 36/no	0 = No
4 = 110Vac (for XWEB500)	N = 50/CRO (1 engine)	1 = Analogue
5 = 230Vac (for XWEB500)	T = 100/no	2 = GSM/GPRS (for XWEB500D)
8 = 110±230Vac (for XWEB500D)		

FEATURES	XWEB500	XWEB500D
Power supply	110, 230Vac	24, 110÷230Vac
LAN output	pres	pres
USB output	2	1
RS485 output	pres	pres
Relay output	3	3
Digital input	pres	pres
Sampling time	from 1 to 60 minutes	from 1 to 60 minutes
External modem	analogue or GSM	analogue or GSM
Internal modem	analogue opt	analogue or GSM/GPRS opt

## HARDWARE

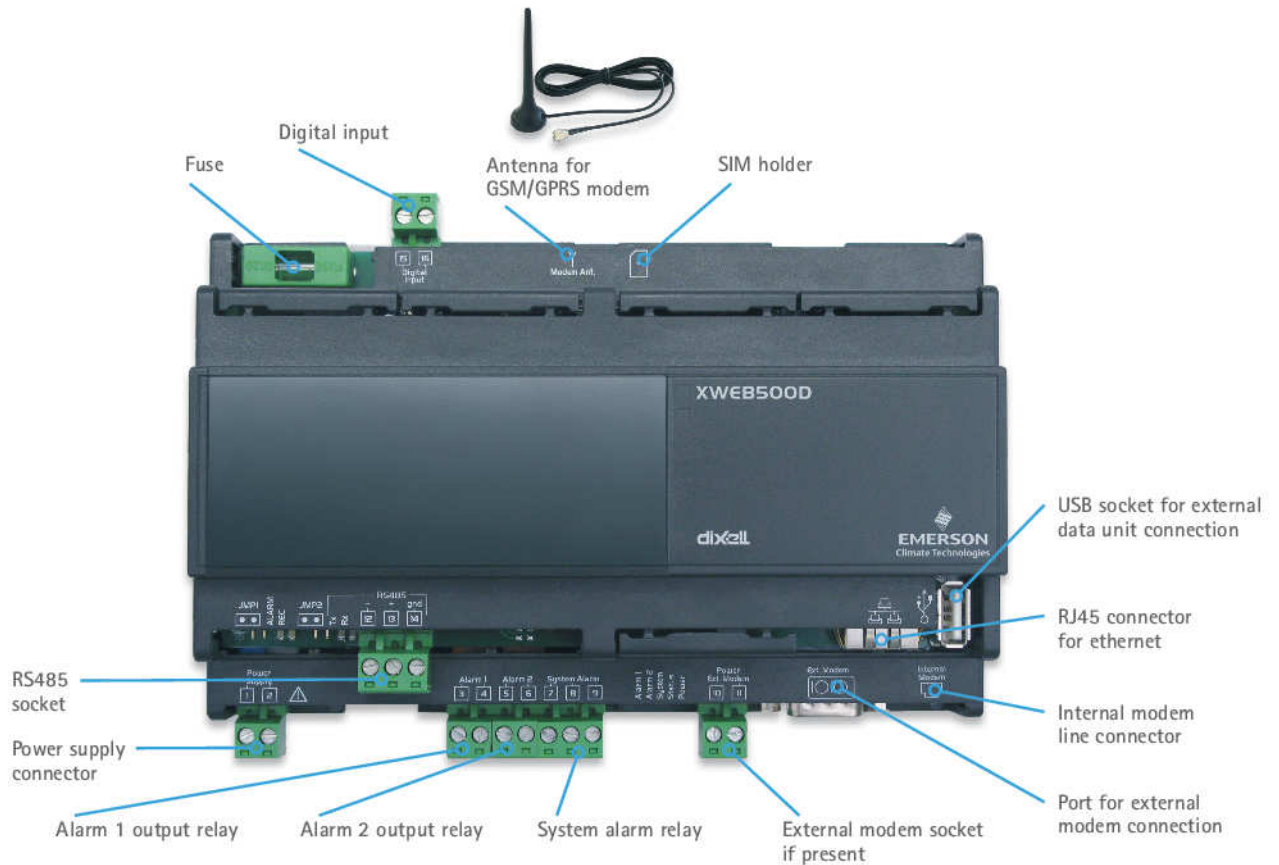
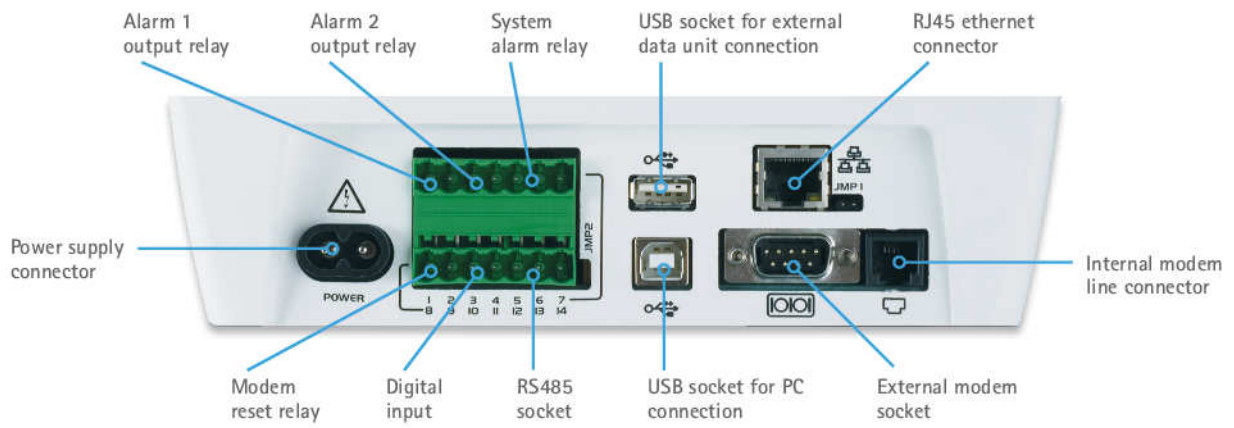

More information about functions and connections at pages 132÷136



370x238mm

## XWEB3000: INDUSTRIAL MONITORING and CONTROLLING

It is extremely well suited for larger installations with up to 247 devices such as supermarkets, hypermarkets or large storage and distribution centers as well as production and storage goods processing such as fast-food, restaurants, catering up to medical and pharmaceutical applications. XWEB3000 is the ideal solution for service needs (modem, ethernet and internet connection); it can operate, as a stand-alone server without using a PC but it's also simple to connect a monitor, keyboard and mouse. Local or remote connection from a PC is made without the need of special software; only a standard web browser (Microsoft Internet Explorer® and Firefox®) software is needed.

- Data capture and alarm monitoring WEB server connectable to Dixell's controllers with serial output or to others ModBUS-RTU compatible devices
- 19" RACK or desk mounting
- Quick and easy connection to Web pages with dedicated interface for PDA/Smartphone
- All controller values can be shown using a special "Single View" window or using "Run Time" window where many controllers can be viewed at the same time. It is even possible to use a "Layout" view of the plant with pictures and schematics drawings
- Complete and simplified analysis of the unit functioning thanks to a powerful tool that allows to view data in graphical format (Excel®)
- One year of stored data inside the XWEB memory (one year of stored data with 15min sampling time)
- Easy plant management by means of the "Scheduler" to send commands according to a custom calendar
- Calendar function and internal RTC both for alarm transmission to the "in charge" service and command sending to the controllers
- Possibility to divide the controllers set in different categories of products with their own sampling time
- Ability to select particular data on which to perform the monitoring with reduced sampling time
- Alarm sending via FAX, SMS or e-mail
- Commands sending activation through digital input
- Standard communication protocol ModBUS-RTU
- 50VA max power absorption

### HOW to ORDER

XWEB3000 X W E B 3 0 0 0 - 6 0 0 0 E

E

Internal modem

0 = No

1 = Yes



Easy configuration, efficient management of all controller values and a display of controllers also using pictures and schematic drawings: these are some of the XWEB3000's strengths. It is an intuitive, powerful and at the same time, very versatile device. This web server allows parameter and alarm management with different levels and typologies, providing the user with the possibility to divide the controllers into different categories, each with their own sampling periods. Powerful tools include: the scheduler which is a graphic instrument created to manage commands sent to the controllers, data export used to save data in a Microsoft Excel file, and the back-up function to have data-safe protection even in the worst environmental usage, also to save all the unit setup.

The alarm signalling for service is very flexible and can be done through FAX, e-mail, SMS and also via relay outputs.



FEATURES	XWEB3000
Power supply	110÷230Vac
LAN output	pres
USB output	2
RS485 output	pres
Relay output	3
Digital input	pres
Printer output	25 pin
Keyboard/mouse output	pres
Video output	pres
Sampling time	from 1 to 255 minutes
External modem	analogue
Internal modem	analogue opt

## HARDWARE

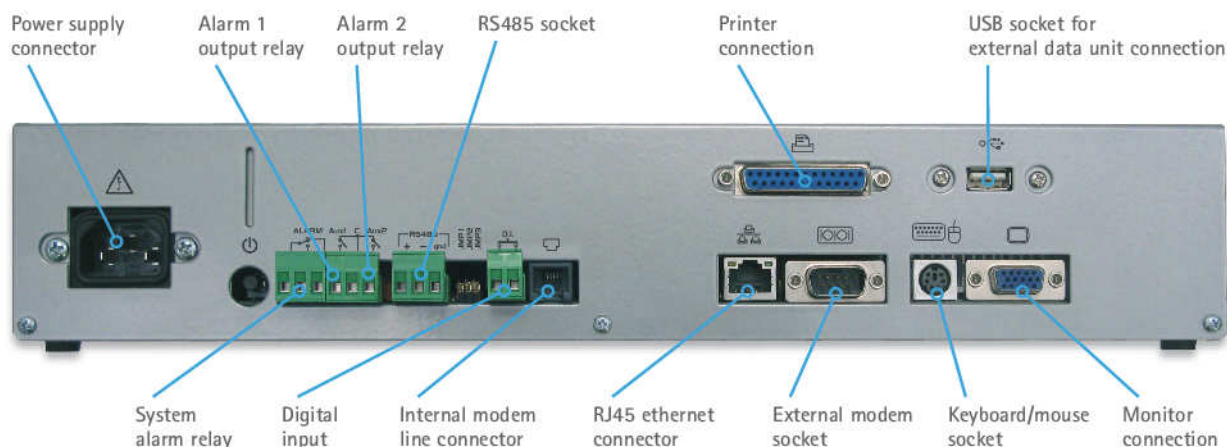

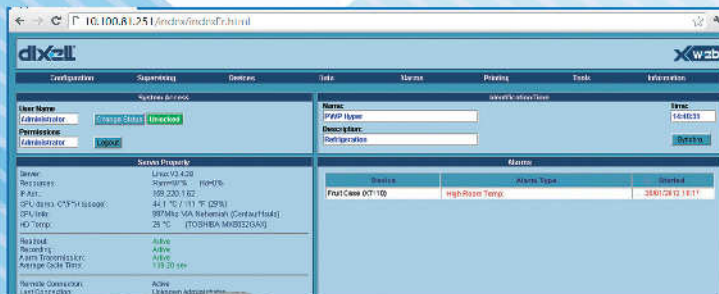

370x238mm



## XWEB5000: MONITORING, CONTROLLING and SUPERVISING

It is provided with a powerful supervision engine suited for larger installations (with up to 247 devices) in the refrigeration, conditioning and building automation field, where it is necessary to program several different interactive actions that the controller has to perform. It is extremely well suited to hypermarkets, large storage and distribution centres, as well as production and storage goods processing and is ideal for the large service center (modem, ethernet and internet connection). The system manages the alarm transmission to the "in charge" service (via FAX, e-mail, SMS and also through relay outputs) and it can also work without a PC using direct connection of a monitor, keyboard and mouse. Local or remote connection PC is made using Microsoft Internet Explorer® and Firefox® browser.

- Monitoring, controlling and supervising web server connection to Dixell's controllers with serial output and to other ModBUS-RTU compatible devices
- 19" RACK or desk mounting
- Built-in editor with local and field simulator
- Quick and easy connection to Web pages with dedicated interface for PDA/Smartphone
- All controller values can be displayed using a special "Single View" window or a "Run Time" window with many controllers viewed at the same time. The ability to use a "Layout" view of the plant with pictures and schematic drawings is also an option
- Complete and simplified analysis of the unit functioning thanks to a powerful tool that allows to view data in graphical format (Excel®)
- One year of stored data inside the XWEB memory (one year of stored data with 15min sampling time)
- Easy plant management by means of the "Scheduler" to send commands according to a custom calendar
- Calendar function and internal RTC both for alarm transmission to the "in charge" service and command sending to the controllers
- Possibility to divide the controllers set in different categories of products with their own sampling time
- Ability to select particular data on which to perform the monitoring with reduced sampling time
- Alarm sending via FAX, SMS or e-mail
- Commands sending activation through digital input
- Standard communication protocol ModBUS-RTU
- 50VA max power absorption
- DPC (Dew Point Control) for anti-sweat heater management

### HOW to ORDER

XWEB5000 X W E B 5 0 0 0 - 6 0 0 0 E

E

Internal modem

0 = No

1 = Yes

## SUPERVISING

With XWEB5000 it is possible to intercept sending commands to monitored devices. The installer can create a supervision "Project" (or several "Projects") by programming links between the input variables (inputs, status and outputs of a controller) and defining what actions the system must take when these conditions are met. Unlike a standard PLC, where the user is required to know a specific programming language, with the XWEB5000 the "project" can be easily created using a simple graphic user interface, but more importantly, without the need to learn a complex programming language. Specific software is not necessary: the supervising software has been written in JAVA and it runs on the client PC. The project is saved to the XWEB5000; several projects can be run simultaneously.

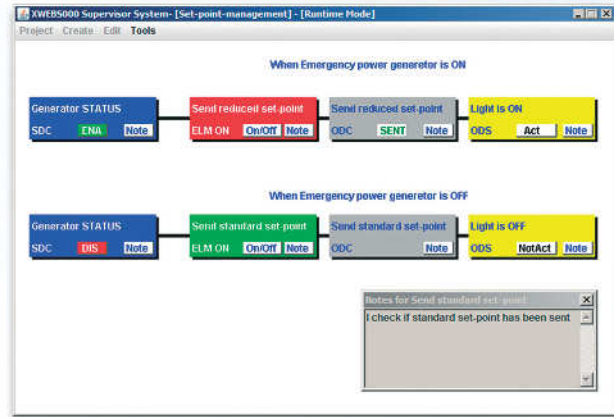

## AUTOMATION

The high versatility and programmability allow the XWEB5000 to perform automation programs. In fact it's possible, for example, to manage the use of plant lights, internal or external signs, the battery charge/discharge as fork lifts, increasing the energy saving process. In case of compressor fault or when the absorption threshold exceeds the set, etc., the monitoring unit can automatically interact with the rest of system.

## FEATURES

### XWEB5000

Power supply	110÷230Vac
LAN output	pres
USB output	2
RS485 output	pres
Relay output	3
Digital input	pres
Print output	25 pin
Keyboard/mouse output	pres
Video output	pres
Sampling time	from 1 to 255 minutes
External modem	analogue
Internal modem	analogue opt

## HARDWARE

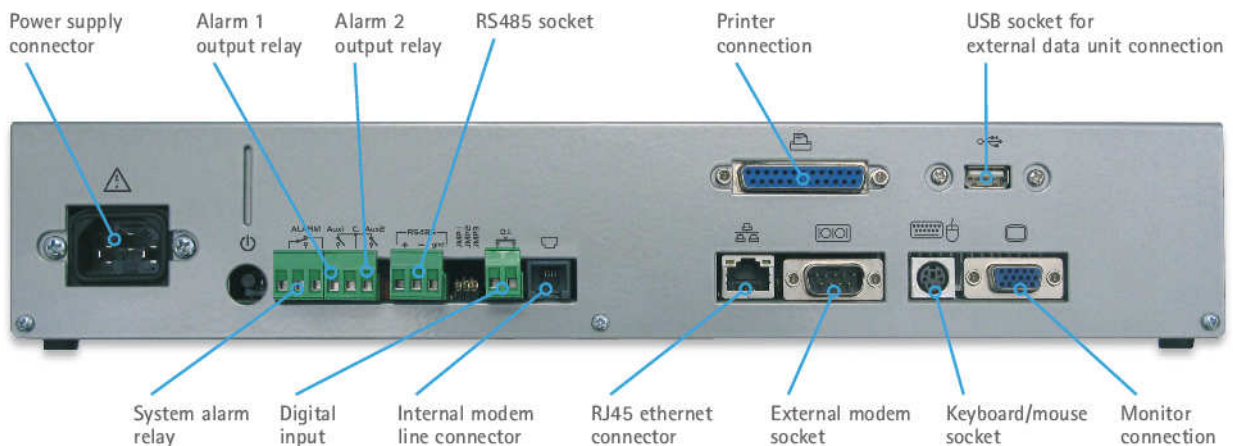

More information about functions and connections at pages 132÷136

# XWEB FUNCTIONS

An overview of some most important XWEB family functions.

RS485 monitor - Mozilla Firefox

http://192.168.1.62/Service/Reports/06.php

Address	Model	Name	TK	OK	% OK	Time	TimeOut	Exception	Total
127	XWEB3K	13 HLI	1895	0	0	0:00:03.190	0		Test
128	XWEB3K	Liquid Store CHR LBI	1895	0	0	0:00:03.190	0		Test
119	XWEB3K	Liquid Store CHR LBI	1877	0	0	0:00:03.190	0		Test
76	XWEB3K	13 HLI	22615	19686	87.00	0:33:36.667	0	15.87	Test
77	XWEB3K	13 HLI	22765	19806	87.00	0:33:36.666	0	15.86	Test
78	XWEB3K	13 HLI	22731	19771	86.56	0:33:36.666	0	15.86	Test
79	XWEB3K	13 HLI	22725	19775	86.56	0:33:36.666	0	15.86	Test
80	XWEB3K	13Set Deli	22742	19794	86.62	0:33:36.667	0	15.87	Test
85	XWEB3K	14gs Bakery	22765	19804	87.00	0:33:36.667	0	15.86	Test
86	XWEB3K	21H Fruit & Veg	22722	19751	86.55	0:33:36.667	0	15.87	Test
90	XWEB3K	Roast in Rin Fruit & Veg	22722	19729	86.87	0:33:36.666	0	15.86	Test
118	XWEB3K	10G High Meat	22734	19779	86.56	0:33:36.666	0	15.86	Test
119	XWEB3K	10G High Meat	22740	19783	86.56	0:33:36.667	0	15.87	Test
121	XWEB3K	10g Ocumat	22718	19756	86.52	0:33:36.667	0	15.86	Test
80	XWEB3K	11w Dairy	22715	19758	86.52	0:33:36.666	0.02	15.86	Test
150	ENERPO-ANAL	Energy Analyzer	10400	94015	90.62	0:38:10.338	0		Test
1	XWEB3K	15H Sa Icecream	22710	22721	99.89	0:01:01.001	0		Test
25	XWEB3K	11w Dairy	22678	22674	99.89	0:01:02.002	0		Test
28	XWEB3K	11w Dairy	22742	22723	99.84	0:01:01.016	0		Test
33	XWEB3K	10w CHR COC1	18793	18729	99.59	0:01:01.001	0		Test
34	XWEB3K	10w CHR COC2	18800	18756	99.83	0:01:01.017	0		Test
99	XWEB3K	Bakery CHR H	18803	18801	99.89	0:01:01.001	0		Test
105	XWEB3K	Dairy CHR F1	18785	18786	99.89	0:01:01.001	0		Test

## RS485 LINE-CHECK

A powerful new tool is able to check performance and statistical data for each controller by carrying out a functional test for every device connected to the RS485 network. You can then have information regarding the quality of the connection. The tool is very useful especially when there is the necessity analyze a network problem; with statistics that allow you to easily identify which instrument has a connection problem.

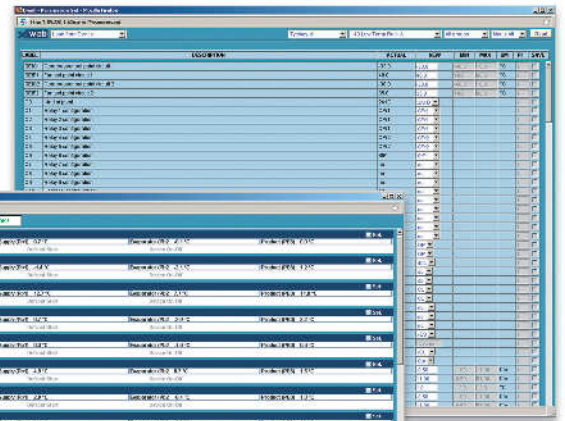

## PARAMETER PROGRAMMING and RUN TIME

Thanks to the XWEB the user has an intuitive, powerful and versatile device all in one that allows modification of various functioning parameters of the instruments. It will no longer be necessary to make manual adjustments on the controller, because by using the different windows available, and with a few simple operations, it is possible to obtain the required updating. The Run Time function displays many devices together in a unique window. This is dynamic page and the data showed is updated in real time. The status of the devices connected (also from different manufacturers) is displayed simply and clearly and it is possible to modify the various functioning parameters of the instruments.

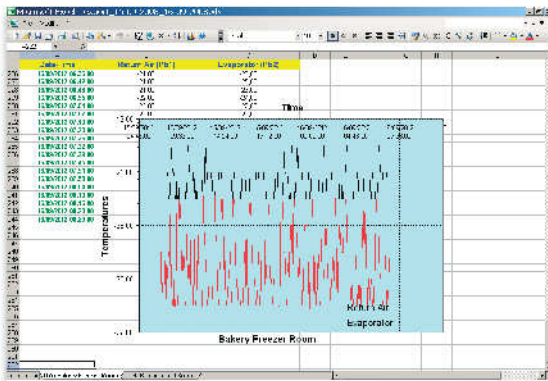
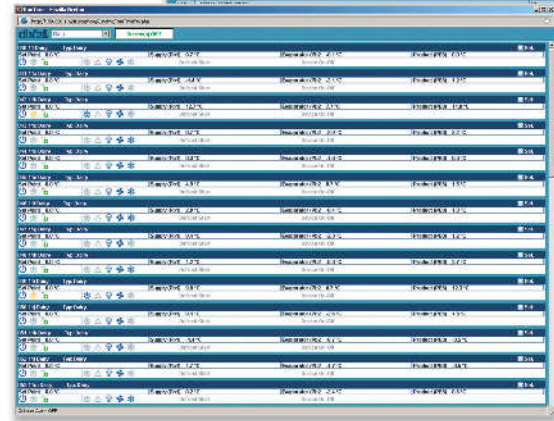

## DATA EXPORT

It is possible to export all data information in a Microsoft Excel® file. The user can later use this information to build graphs or to collect data. It is possible to select a data interval and filter between different controllers.

## LAYOUT & GLOBAL COMMANDS

(for XWEB5000, XWEB500, XWEB3000, XWEB5000)

A powerful graphic editor that doesn't require the installation of any additional software on your PC is what makes XWEB layout the ideal solution. Using this function, the user can access all the recorded data of the controllers and even send a command to a controller. Global Commands option let you send multiple commands to one or more controllers at the same time. In addition, using the digital input it is possible to automatically start the sending of commands.

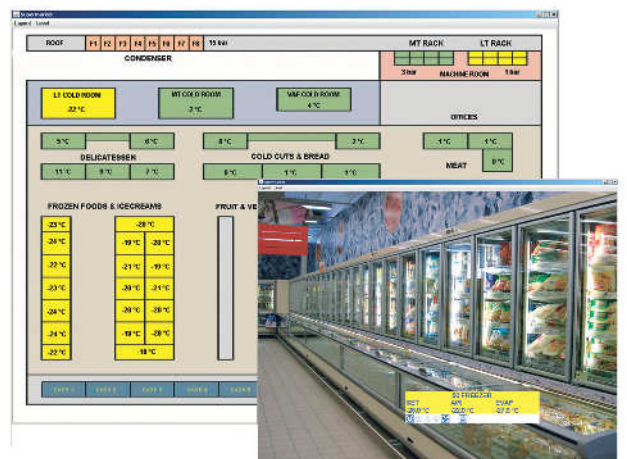

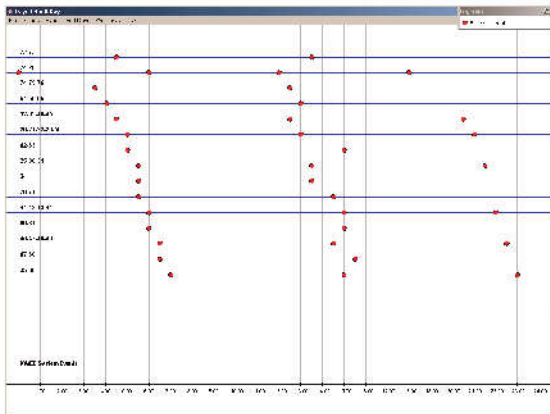

## SCHEDULER (for XWEB500D, XWEB500, XWEB3000, XWEB5000)

The scheduler is a powerful graphic tool to manage commands sent to the controllers. You can quickly see an overview of all daily activity. This means that energy saving routines and defrosts can be easily scheduled.

## PERFORMANCE METER (for XWEB500D, XWEB500, XWEB3000, XWEB5000)

This highly appreciated function allows users to verify the right temperature for single devices (wall cabinets, benches, rooms, and more). The graphical layout offers a complete view of the plant operating mode.

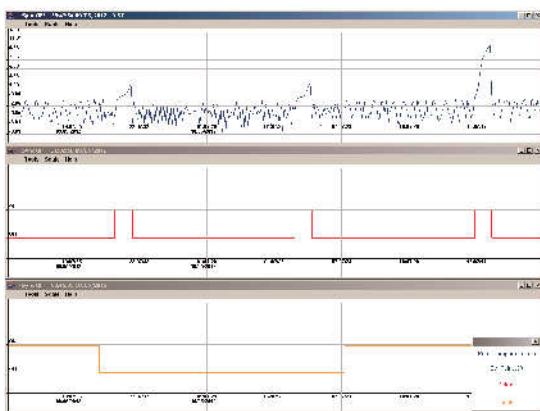
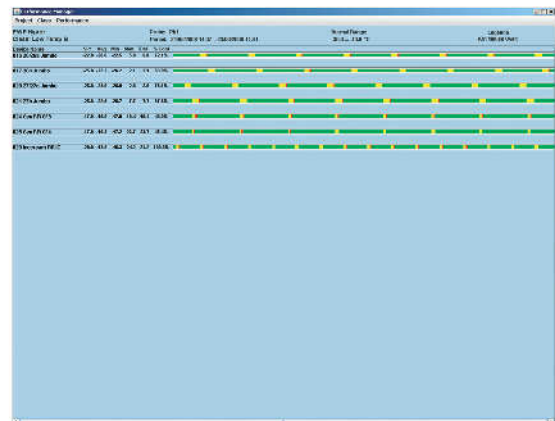

## GRAPHICS (for XWEB3000, XWEB5000, XWEB500, XWEB3000, XWEB5000) CIRCULAR GRAPHICS (for XWEB3000, XWEB5000)

The XWEB can supply powerful graphs that are able to represent multiple analog variables on the same pictorial system and the course of the status of the outputs and alarms. This allows the user to have a precise snapshot view of important variables for easy diagnosis of faults. Thanks to the high sampling rate of circular graphs, they are more detailed and appreciated by service personnel for diagnostics.

## CRO (for XWEB500D, XWEB500, XWEB5000)

Thanks to the special CRO algorithm (Compressor Rack Optimization), the connection to the modern supervising systems (of Dixell) allows the management of the compressor rack set point in the best possible way, depending on the devices connected, which can result in plant optimization and energy savings. The system, equipped with the CRO function, analyzes the information from the controller to determine if a controller needs more refrigeration power and how much. The set point will be recalculated in order to satisfy the worse instance and sent from the supervising system to the XC1000D compressor rack controller; this will be the new working set point. If the supervising system can't manage the XC1000D, it's the controller that "decides" to replace the set point (coming from the system) and will then re-define the set point in the planning phase of a refrigeration plant. The two graphs emphasize that when the CRO algorithm is active, in a real installation, the set point becomes on average higher, and consequently the energy consumption decreases. The dotted line represents the average weekly value.

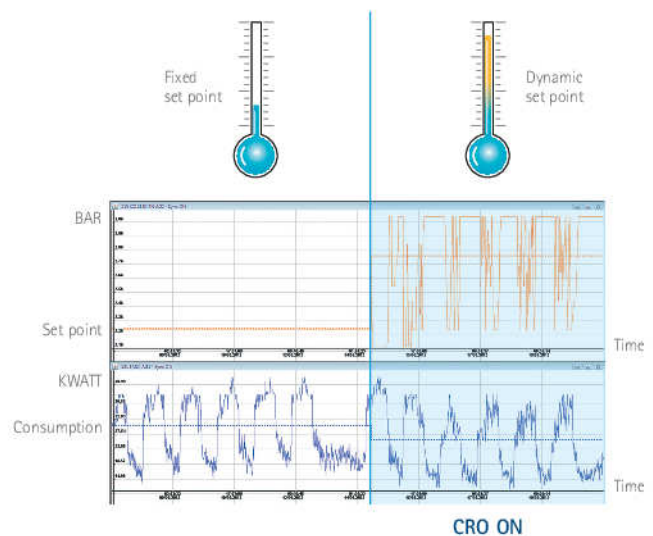

# XWEB CONNECTIONS

The high connectivity is one of the main XWEB family's strengths; see below for an overview of several methods to connect with the systems.

## CONNECTION via SMARTPHONE/PDA

When the connection is made by means of a Palmtop computer (PDA), the XWEB automatically recognizes it and makes several dedicated pages available. It is possible to display all the values of a device and send it commands on the PDA.



## LOCAL CONNECTIONS

XWEB server and associated systems can be locally linked connecting the system to a PC.



The complete and powerful hardware platform typical of XWEB3000 and XWEB5000 systems allows them to be used as the local machine by way of monitor, keyboard and mouse connection.



## REMOTE CONNECTIONS

XWEB Servers can be remotely accessed using several methods:

- by modem with point to point connection, also with GSM modem (only for devices that support it);
- by link in local Ethernet network, by means of standard net connector RJ45;
- by direct Internet connection, if provided with a public and static IP address.

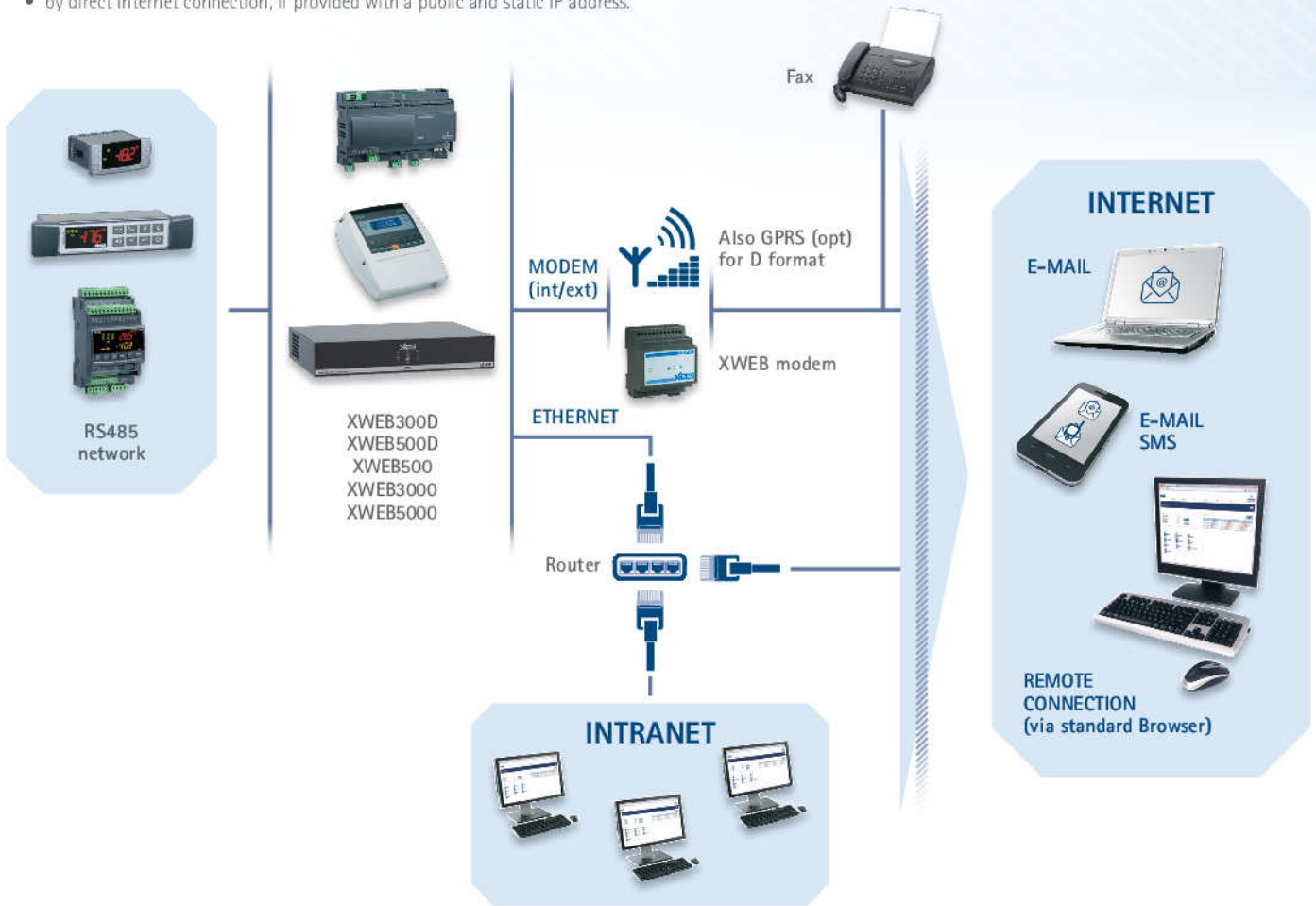

The GPRS connectivities are a popular favorite, which distinguishes it as a best-solution in case of alarm management with medium-small applications, and the ETHERNET in case of tele-assistance and control with medium-large applications.

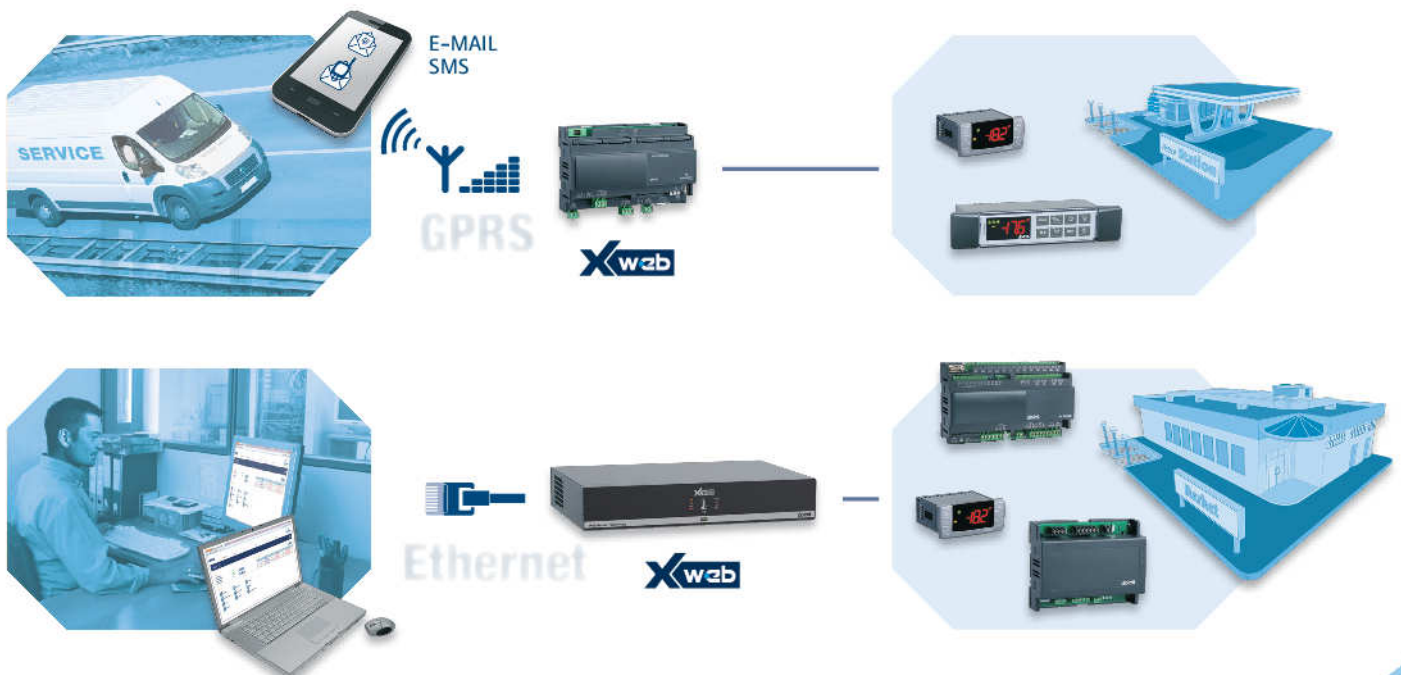

# XWEB SYSTEM GUIDE

	XWEB300D	XWEB500D	XWEB500	XWEB3000	XWEB5000
Applications	small and medium	medium and large	medium and large	large	large with supervision
Format	10 DIN Rail	10 DIN Rail	210x230x87h	350x235x47h	350x235x47h
Power supply	24Vac or 110±230Vac	24Vac or 110±230Vac	110Vac or 230Vac	110±230Vac	110±230Vac
Display			•		
N° of instruments	6 - 18	36 - 100	100	247	247
USB port for PC connection			•		
USB output for device connection	•	•	•	•	•
Relay output	1	3	3	3	3
Digital input		•	•	•	•
LAN output	•	•	•	•	•
RS485 output	•	•	•	•	•
External modem	analogue or GSM	analogue or GSM	analogue or GSM	analogue	analogue
Internal modem	analogue or GSM/GPRS opt	analogue or GSM/GPRS opt	analogue opt	analogue opt	analogue opt
Sampling time	from 1 to 60 minutes	from 1 to 60 minutes	from 1 to 60 minutes	from 1 to 255 minutes	from 1 to 255 minutes
RS485 line check	•	•	•	•	•
Parameter programming	•	•	•	•	•
Run time function	•	•	•	•	•
Data export in Excel® format	•	•	•	•	•
Graphics	•	•	•	•	•
Layout function		•	•	•	•
Scheduler function		•	•	•	•
Global commands		•	•	•	•
Performance meter		•	•	•	•
Circular graphics				•	•
Supervision module					•
CRO module		•	•		•



# SuperMarket



80x80mm

**iCOOLL**

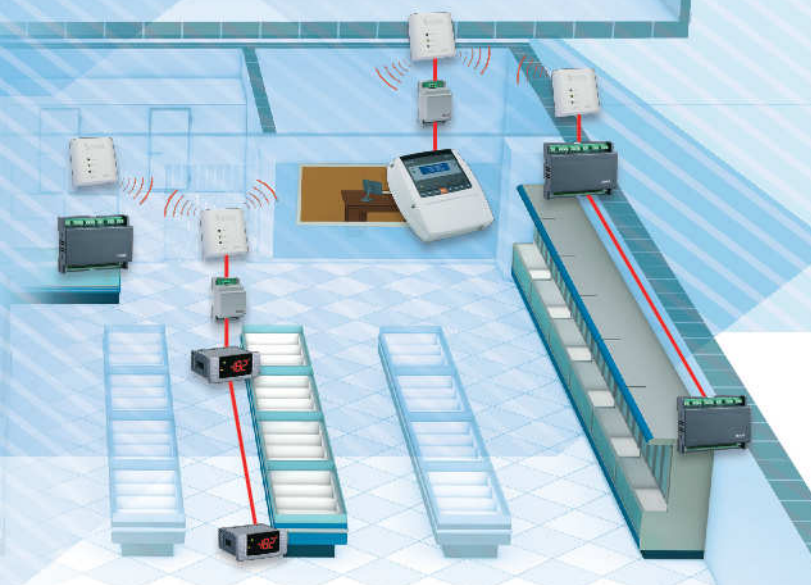

## iCOOLL SERIES: WIRELESS SOLUTION

- TX/RX modules (**XJ200**) for wireless network dedicated to data monitoring (the master module has to be connected to the XWEB, the slave modules are connected to the instruments through the ModBUS protocol)
- Self-configuring MESH system for the optimization of communication (the network is able to create and to use all possible "connections" between the master and the slave node)
- User-friendly and less installation time and costs
- Operating frequency: 868Mhz (922Mhz for US market – FCC approved)
- High range (450m no obstacles)
- Ability to connect up to 240 instruments to the same XJ200
- Ability to manage up to 20 HOP
- Ability to connect up to 40 XJ200 to the same net
- 1,5m wire (power supply/RS485) with functional bracket included (**fig. 1**)
- Standard communication protocol ModBUS-RTU
- 0,25VA max power absorption

fig. 1



### HOW to ORDER

XJ200 X J 2 0 0 - A 0 0 0 0

A

Frequency

0 = 868Mhz

1 = 922Mhz

### ACCESSORY

PW200J

Power supplier for XJ200 modules with TTL-RS485 converter





100x64mm

## XJM: I/O MANAGEMENT

- Acquisition and command module for refrigeration, air conditioning and BMS applications
- Great flexibility: all the necessary I/O types in one device
- Configurable analog inputs
- Data acquisition by means of sensors with alarm limits
- Up to 12 digital inputs for alarms, status and sensors interlock
- Pressure/temperature conversion
- Available with or without display
- Hot Key or Prog Tool Kit connector for quick and easy programming
- Serial connection to monitoring systems or BMS
- 20VA max power absorption
- Dual display with red LED (8,5mm high) and yellow LED (7,5mm high) and 17 icons

### TYPICAL APPLICATIONS

Retrofit and data acquisition for:

- Cabinets
- Cold rooms with 2 evaporators
- Compressor racks up to 4 compressors
- Pulses counters

### HOW to ORDER

XJM60D    X   J   M   6   0   D   -   A   B   C   0   0

VJM60    V   J   M   6   0   -   0   0   0   0   0

A	B	C
<b>Power supply</b>	<b>Display</b>	<b>N° of relay</b>
2 = 24Vac	0 = No	1 = 1
4 = 110Vac	1 = Yes	4 = 4
5 = 230Vac		

# MULTIFUNCTION MODULE and KEYBOARD for INPUT and OUTPUT MANAGEMENT

XJM

- XJM60D** | Multifunction module for inputs and outputs with management of up to 4 relays
- VJM60** | Keyboard for XJM60D module



D: 4 DIN Rail



100x64mm

FEATURES	XJM60D				VJM60
First display: n° digits	4 d.p.	no display	4 d.p.	no display	4 d.p.
Second display: n° digits	4 d.p.		4 d.p.		4 d.p.
Power supply	24Vac	24Vac	110, 230Vac	110, 230Vac	from controller
<b>Inputs</b>					
Probe	6 x config*	6 x config*	6 x config*	6 x config*	
Digital (free of voltage)					
Digital (power supply voltage)	6	6	2	2	
<b>Relay outputs</b>					
Configurable	1 x 5A, 4 x 5A	1 x 5A, 4 x 5A	1 x 5A	1 x 5A	
<b>Other</b>					
Hot Key/Prog Tool Kit	pres	pres	pres	pres	
Remote keyboard		VJM60		VJM60	
Analog output	4÷20mA/0÷10V	4÷20mA/0÷10V	4÷20mA/0÷10V	4÷20mA/0÷10V	
Serial output	RS485	RS485	RS485	RS485	

\* Up to 6 digital inputs or 6 x NTC/PTC/Pt1000 probe inputs or 3 x NTC/PTC/Pt1000 probe inputs + 3 x 4÷20mA/0÷5V/0÷10V/pulse probe inputs

## XJM60D

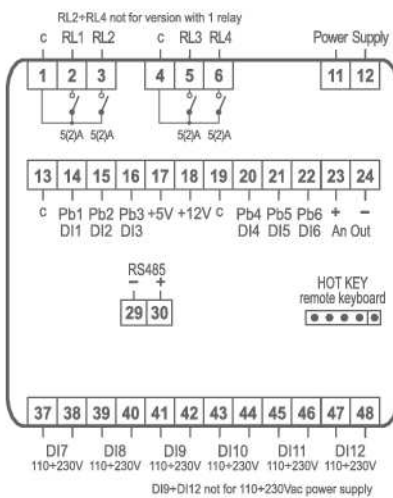



## XJA-XJP-XJR SERIES: RELAY and ACQUISITION MANAGEMENT

- Digital inputs for local enable/disable of relays (XJR)
- Data acquisition modules suitable for collecting data from any kind of installation (XJP)
- Up to 6 inputs for NTC, PTC, 4÷20mA and 0÷10V and 3 digital inputs or 4 Pt100 inputs and 4 digital inputs (XJP)
- Up to 10 line voltage inputs (XJA)
- Direct line power supply 230 (110)Vac. No external transformer required
- Remote display option
- Hot Key or Prog Tool Kit connector for quick and easy programming
- Serial connection to monitoring systems
- 6VA max power absorption

### HOW to ORDER

XJR X J R 4 0 D - A 0 C 0 0

A	C
<b>Power supply</b>	<b>Buzzer</b>
2 = 24Vac	0 = No
4 = 110Vac	1 = Yes
5 = 230Vac	

XJA-XJP30/60 X J D - A B C D E

XJP40 X J P 4 0 D - A B 0 R 4

XJA50SL X J A 5 0 S L - A 0 0 0 0

A	B	C	D	E
<b>Power supply</b>	<b>Measurement unit</b>	<b>Alarm relay</b>	<b>Probe inputs</b>	<b>Digital inputs</b>
2 = 24Vac	C = °C	0 = No	P = PTC	3 = 3 (only for XJP30/60D)
4 = 110Vac	F = °F	1 = Yes (only for XJA50D)	N = NTC	5 = 5 (only for XJA50D)
5 = 230Vac	N = No temperature		A = 4÷20mA	6 = 6 (only for XJP30D)
			W = 0÷10V	
			0 = No	

# KEYBOARD and RELAY MODULES and PROBE and ALARM ACQUISITION MODULES

# XJA-XJP-XJR

<b>XJA50D</b> <b>XJA50SL</b>	Alarms/status acquisition modules able to read up to 5 + 5 independent inputs (master + slave)
<b>XJP30D</b> <b>XJP40D</b> <b>XJP60D</b>	Probes and alarms data acquisition modules able to read up to 9 different inputs
<b>XJR40D</b>	Relay module able to manage up to 4 independent outputs
<b>KB1 PRG</b>	Programming keyboard for XJA50D - XJP30D - XJP40D - XJP60D - XJR40D modules



D: 4 DIN Rail

100x64mm

FEATURES	XJA50D	XJA50SL	XJP30D	XJP40D	XJP60D	XJR40D	KB1 PRG
Display: n° digits							± 3 d.p.
Keyboard: push buttons						4	6
Power supply	24, 110, 230Vac	from controller	24, 110, 230Vac	24, 110, 230Vac	24, 110, 230Vac	24, 110, 230Vac	from controller
<b>Inputs</b>							
Analogue			3 x NTC, PTC, 4÷20mA, 0÷10V	4 x Pt100	6* x NTC, PTC, 4÷20mA, 0÷10V		
Digital (power supply voltage)	5	5	3	4	3		
Digital (free of voltage)			3 opt		3*	4	
<b>Relay outputs</b>							
Alarm	5A opt						
Load						4 x no 8A/nc 5A	
<b>Other</b>							
Hot Key/Prog Tool Kit output	pres		pres	pres	pres	pres	
Remote display/keyboard output	X-REP/KB1 PRG		X-REP/KB1 PRG	X-REP/KB1 PRG	X-REP/KB1 PRG	KB1 PRG	
Serial output	RS485		RS485	RS485	RS485	RS485	
Serial addresses	5	5	3	4	6	1	
Buzzer						opt	

\* XJP60D has 3 analogue inputs that are configurable as free of voltage digital inputs

## XJA50D

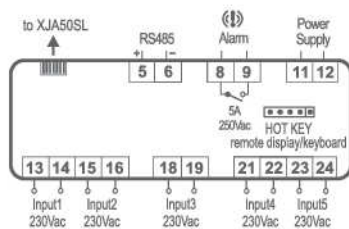

## XJA50SL

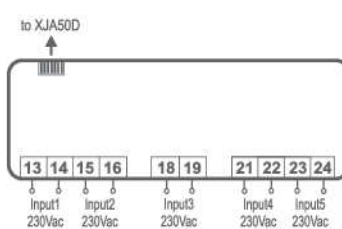

## XJP30D

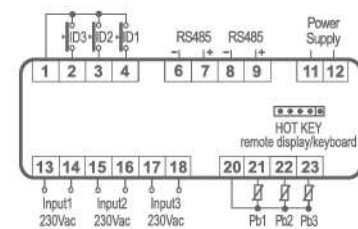

## XJP40D

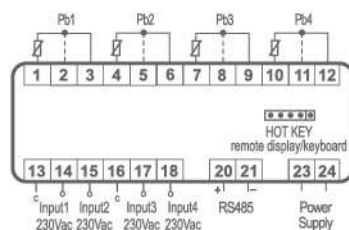

## XJP60D

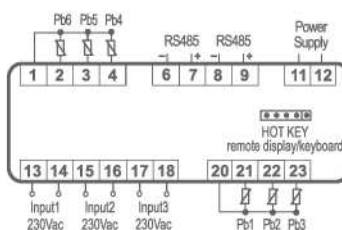

## XJR40D

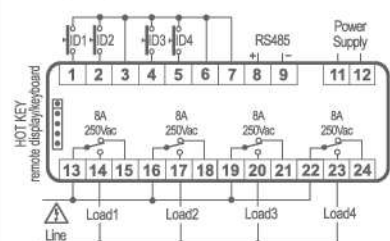

## ACCESSORY

### CAB/KB11

1m cable to connect the keyboard to the XJA-XJP-XJR modules





## XCENTER: CENTRALIZED MANAGEMENT

Designed and developed in order to monitor plants that are positioned in different zones, XCENTER is a flexible, reliable and user-friendly software package. Efficient assistance is a widespread requirement among distribution centers, small and large supermarkets, industrial plants, and more. XCENTER gives this type of support with alarm management, continuous device checks, and recipient management with functional reports. XCENTER doesn't have limits regarding the number of plants and controllers that can be checked and is suitable for every kind of requirement.

- Modular software that, when installed in a server PC, communicates with clients (XWEB systems and remote PC)
- Data and alarms files from real installations, available for all clients
- User interface is simple to understand
- Multilanguage management
- Geo-location positioning and controllers status
- Command sending to real instruments via XWEB interface
- Possibility to quickly modify controllers parameters via XWEB interface
- Alarm setup and management
- Alarm report via e-mail - SMS
- Recipient list management
- Statistical data management in graphical format
- Connection between XCENTER and the monitoring units are by means of internet or telephone line (via dial-up or an internet provider)
- Open project that allows add-on software (warehouse and accountant management,...); development on request

### HOW to ORDER

XCENTER X C E N T E R - A B O O O

A	B
N° of server	N° of client
O = 0	N = 0
A = 1	B = 2
	L = 10

## The XCENTER SOLUTION



The XCENTER software is composed of two parts.

- **XCENTER Server** is a server application that manages the Oracle® database and the communication to all connected XWEB controllers. It contains all receiving and sending notifications of alarms, user management, and control signals.
- **XCENTER Client** is the operator interface that is connected to the XCENTER Server and gives a list of alarms, statistics, and configuration tools of all plants monitored by the XWEB family and their web pages by means of the integrated browser. XWEB gives quick access to the monitored controllers with their parameters, commands, and historical data giving a prompt reply about actual conditions or environment with the ability to intervene remotely to solve possible critical situations.

## XCENTER INSTALLATION LAYOUT

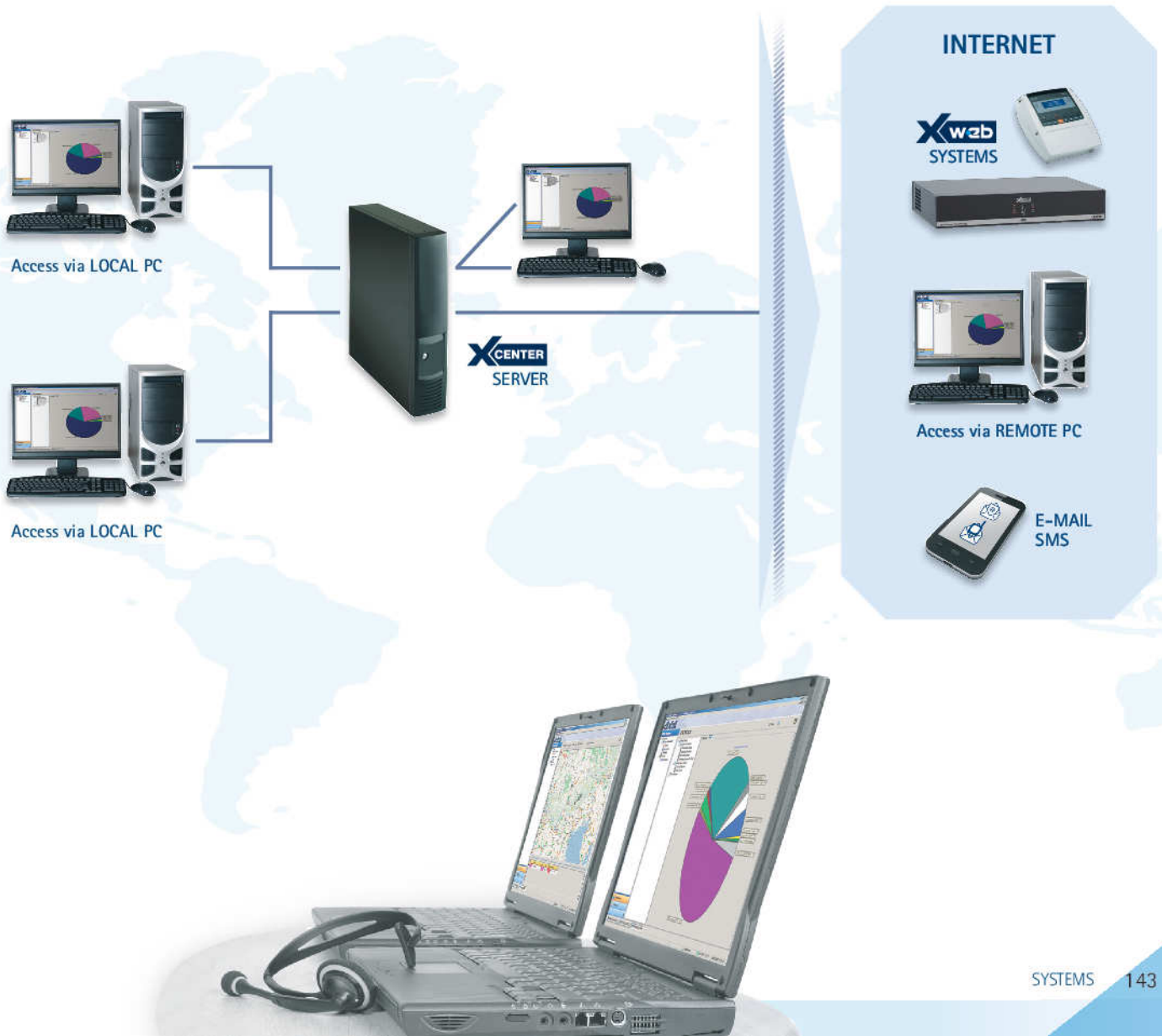

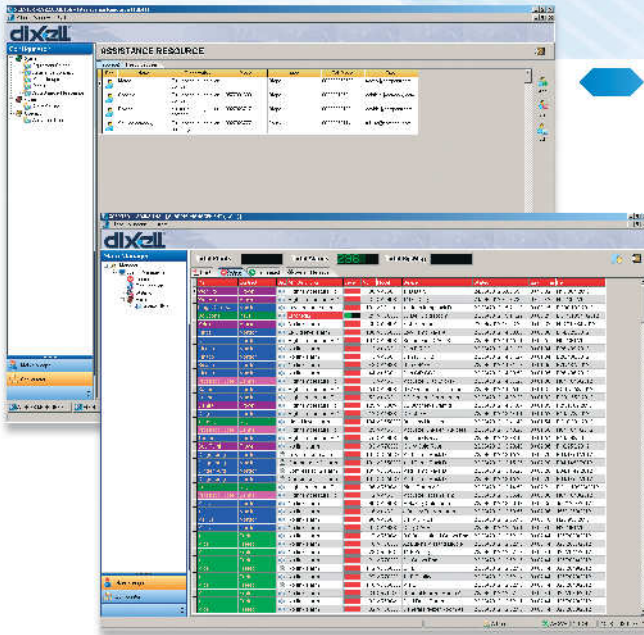

## CONTACTS

XCENTER uses a list of recipients to be contacted for local, regional and national events. Based on need, and according to the alarm severity, the right person will be alerted.

## ALARM MANAGEMENT

With XCENTER the default level of severity can be increased according to the duration, the frequency, the time of the day.

## COMMANDS and PARAMETERS

The XCENTER user is authorized to interact with the controller directly from the program or it has the possibility to be connected to the XWEB and start using it just like via the browser. For every alarm the software creates a report to describe the complete history of the alarm.

## GRAPHICS

Alarms are displayed together with the log of the past 48 hours of the controller functions. It's possible to determine and understand the kind of problem and decide how and when intervene.

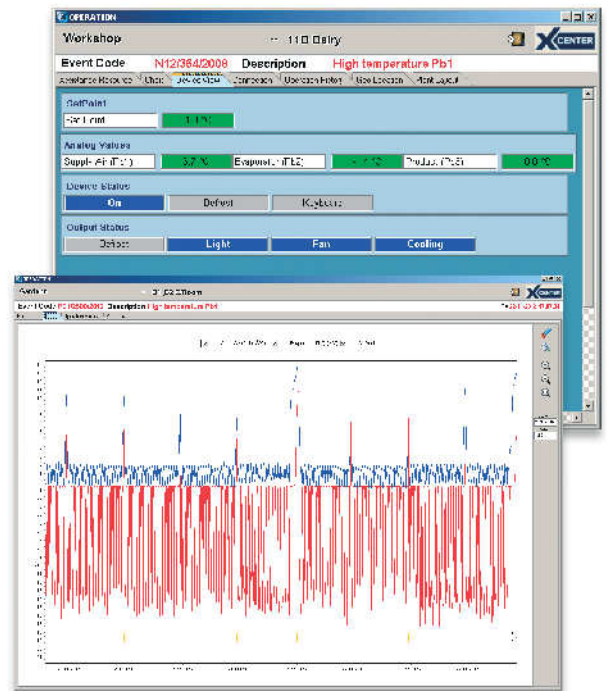

## KEEP ALIVE

The "Keep Alive" function is meant to check the hardware status of the monitored installation periodically to ensure reliability of critical devices.

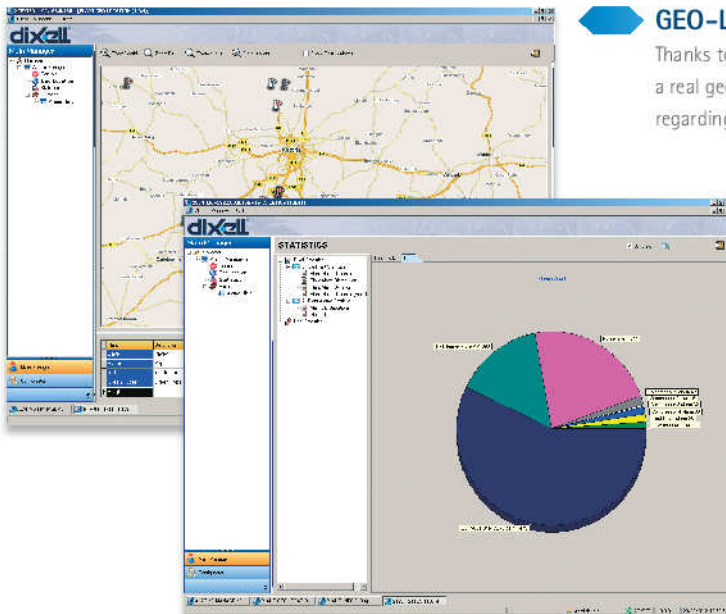

## GEO-LOCATION

Thanks to the mapping technology, it is possible to place your installations on a real geographic map. This feature allows the user to find information quickly regarding any installation that sends an alarm.

## STATISTICS

XCENTER is provided with several models that generate powerful statistical tools that are used to analyze frequent alarms, critical device installations, or sites. The statistics are useful in preventing critical product or plant situations. There is also the possibility to group alarms together by typology, time interval, installation, and more.





# PROBES

## SECTION INDEX

FUNCTIONS	MODELS	
<b>TEMPERATURE PROBE</b>		
		<b>146</b>
NTC probes	NS6 – NS6W – NS6S – NS6SJ – NS6SW – NG6 – NG6F NG6W – NG6K – NG6P – NG6PJ – NX6P – NX6PJ NY6P – NY6PJ – NP4-67 – NT6-67 – NT6 – N6F2	146
PTC probes	S6 – S6.R – S6.S – S6.SH – SA6 – ST6 – SC5.5	147
Pt1000 probes	PMG5P – PMP4-67 – PMT6-67	148
NTC/Pt1000 product probes	NGPOP – PMGPOP	148
PTC/NTC insert probes	SPC10PS – NPC10PS – SPC10IS – NPC10IS SPC10IA – NPC10IA	148
Pt100 thermoresistors	PT6 – PT6.S – PT6.F – PT310 – PT315	149
TC thermocouples	TJ6 – TK6 – TJD215 – TJD320 – TKD215 – TKD320 CMJ – CMK	149
<b>TEMPERATURE/HUMIDITY PROBES</b>		
		<b>150</b>
Temperature/humidity probes	XH50P – XH55P	150
<b>HUMIDITY PROBES</b>		
		<b>151</b>
Humidity probes	XH10P – XH20P	151
<b>PRESSURE PROBES</b>		
		<b>152</b>
Pressure transducers	PP07 – PP11 – PP30 – PP50	152
Ratiometric pressure transducers	PPR15 – PPR30 – PPR45	152



# PROBES

## TEMPERATURE PROBES

### NTC PROBES

The probes with NTC thermistor are designed for applications where high accuracy and the short response time are important. The probes pass several tests, this is why we guarantee a very high reliability.







PROBE	DESCRIPTION	CABLE	TEMP. RANGE	
NS6	General purpose, resinated, IP67, inox steel cap "dimension Ø6x30mm"	PVC 1,5m - 3,0m	-30÷80°C -22÷176°F	
NS6W	General purpose, resinated, IP67, with 6,3mm faston, inox steel cap "dimension Ø6x30mm", for WING K	PVC 1,5m - 3,0m	-30÷80°C -22÷176°F	
NS6S	General purpose, resinated, IP67, inox steel cap "dimension Ø6x30mm"	Silicone 1,5m - 3,0m	-40÷110°C -40÷230°F	
NS6SJ	General purpose, resinated, IP67, 2 pole connector, inox steel cap "dimension Ø6x30mm"	Silicone 1,5m - 3,0m	-40÷110°C -40÷230°F	
NS6SW	General purpose, resinated, IP67, with 6,3mm faston, inox steel cap "dimension Ø6x30mm", for WING K	Silicone 1,5m - 3,0m	-40÷110°C -40÷230°F	
NG6	General purpose, over-molded, IP67, thermoplastic cap "dimension Ø6x15mm"	Thermoplastic 1,5m - 3,0m	-40÷110°C -40÷230°F	
NG6F	General purpose, over-molded, IP67, with 2,8mm faston, thermoplastic cap "dimension Ø6x15mm", for XT115 12Vac and 24Vac/dc	Thermoplastic 1,5m - 3,0m	-40÷110°C -40÷230°F	
NG6W	General purpose, over-molded, IP67, with 6,3mm faston, thermoplastic cap "dimension Ø6x15mm", for WING K	Thermoplastic 1,5m - 3,0m	-40÷110°C -40÷230°F	
NG6K	General purpose, over-molded, IP68, Hot Key connector, thermoplastic cap "dimension Ø6x15mm"	Thermoplastic 1,5m - 3,0m	-40÷110°C -40÷230°F	

<b>NG6P</b>	General purpose, over-molded, IP68, cap "dimension Ø5x20mm"	Thermoplastic 1,5m - 3,0m	-40÷110°C -40÷230°F	
<b>NG6PJ</b>	General purpose, over-molded, 2 pole connector, cap "dimension Ø5x20mm"			
<b>NX6P</b>	Thermoplastic, IP68, inox steel cap "dimension Ø6x20mm"	Thermoplastic 1,5m - 3,0m	-40÷110°C -40÷230°F	
<b>NX6PJ</b>	Thermoplastic, IP68, 2 pole connector, inox steel cap "dimension Ø6x20mm"			
<b>NY6P</b>	Thermoplastic, IP68, inox steel cap "dimension Ø6x50mm"	Thermoplastic 1,5m - 3,0m	-40÷110°C -40÷230°F	
<b>NY6PJ</b>	Thermoplastic, IP68, 2 pole connector, inox steel cap "dimension Ø6x50mm"			
<b>NP4-67</b>	Pipemount fitting "Ø4÷Ø30mm in diameter", IP67, over-molded, copper sensor	Thermoplastic 1,5m - 3,0m	-40÷110°C -40÷230°F	
<b>NT6-67</b>	Pipemount fitting "Ø4÷Ø30mm in diameter", IP67, over-molded, thermoplastic sensor			
<b>NT6</b>	Pipemount fitting	PVC 1,5/2,0m	0÷80°C 32÷176°F	
<b>N6F2</b>	General purpose, resinated, IP67, with 2,8mm faston, double insulation, nylon cap "dimension Ø7x30mm", for XT11S 230Vac	PVC 1,5/2,0m	-30÷105°C -22÷221°F	

## PTC PROBES



The probes with PTC thermistor are designed for both cooling and heating applications.

The temperature range is -50÷150°C (-58÷302°F).

PROBE	DESCRIPTION	CABLE	TEMP. RANGE	
<b>S6</b>	General purpose, resinated, IP67, inox steel cap "dimension Ø6x30mm"	PVC 1,5m - 3,0m	-30÷80°C -22÷176°F	
<b>S6.R</b>	Water proof, resinated, IP67, inox steel cap "dimension Ø6x40mm"	PVC 1,5m - 3,0m	-30÷80°C -22÷176°F	
<b>S6.S</b>	Water proof, resinated, inox steel cap "dimension Ø6x40mm"	Silicone 1,5m - 3,0m	-50÷120°C -58÷248°F	
<b>S6.SH</b>	Heating applications, inox steel cap "dimension Ø6x40mm"	Silicone 1,5m - 3,0m	-50÷150°C -58÷302°F	
<b>SA6</b>	Perforated for air, inox steel cap "dimension Ø6x30mm"	PVC 1,5m - 3,0m	0÷80°C 32÷176°F	
<b>ST6</b>	Pipemount fitting	PVC 1,5m - 3,0m	0÷80°C 32÷176°F	
<b>SC5.5</b>	Probe fixed with threaded male, inox steel cap "dimension Ø6x80mm"	PVC 1,5m - 3,0m	-30÷80°C -22÷176°F	

## Pt1000 PROBES

Pt1000 probes are suitable for all applications where the temperature is between  $-50 \div 120^{\circ}\text{C}$  ( $-58 \div 248^{\circ}\text{F}$ ) and it is important to maintain precision over long distances.

PROBE	DESCRIPTION	CABLE	TEMP. RANGE	
PMG5P	Thermoplastic, resinated, IP68, cap "dimension $\varnothing 5 \times 20\text{mm}$ "	Thermoplastic 1,5m - 3,0m	$-50 \div 110^{\circ}\text{C}$ $-58 \div 230^{\circ}\text{F}$	
PMP4-67	Pipemount fitting " $\varnothing 4 \div \varnothing 30\text{mm}$ in diameter", IP67, over-molded, copper sensor	Thermoplastic 1,5m - 3,0m	$-50 \div 110^{\circ}\text{C}$ $-58 \div 230^{\circ}\text{F}$	
PMT6-67	Pipemount fitting " $\varnothing 4 \div \varnothing 30\text{mm}$ in diameter", IP67, over-molded, thermoplastic sensor	Thermoplastic 1,5m	$-50 \div 120^{\circ}\text{C}$ $-58 \div 248^{\circ}\text{F}$	



## PRODUCT PROBE NTC/Pt1000

The product probes with NTC or Pt1000 sensors allow the simulation and display of product temperature and manage alarms according to the temperature near the product and not the air around it. Thanks to the magnets, these probes are particularly suitable for use on shelves.

PROBE	DESCRIPTION	CABLE	TEMP. RANGE	
NGPOP	NTC sensor, thermoplastic, IP68, $100 \times 100\text{mm}$	Thermoplastic 5m	$-40 \div 110^{\circ}\text{C}$ $-40 \div 230^{\circ}\text{F}$	
PMGPOP	Pt1000 sensor, thermoplastic, IP68, $100 \times 100\text{mm}$	Thermoplastic 5m	$-50 \div 120^{\circ}\text{C}$ $-58 \div 248^{\circ}\text{F}$	





## PTC/NTC INSERT PROBES

The insert probes with PTC or NTC sensor are suitable for applications where it is important to know the core temperature of goods. They are generally used together with cooking oven or blast chiller controllers.

PROBE	DESCRIPTION	CABLE	TEMP. RANGE	
SPC10PS	PTC sensor, plastic handle, inox steel cap "dimension $\varnothing 3,5 \times 100\text{mm}$ "	Silicone 3m	$-38 \div 80^{\circ}\text{C}$ $-36 \div 176^{\circ}\text{F}$	
NPC10PS	NTC sensor, plastic handle, inox steel cap "dimension $\varnothing 3,5 \times 100\text{mm}$ "	Silicone 3m	$-30 \div 80^{\circ}\text{C}$ $-86 \div 176^{\circ}\text{F}$	
SPC10IS	PTC sensor, plastic handle, inox steel cap "dimension $\varnothing 3,5 \times 100\text{mm}$ "	Silicone 3m	$-50 \div 120^{\circ}\text{C}$ $-58 \div 248^{\circ}\text{F}$	
NPC10IS	NTC sensor, plastic handle, inox steel cap "dimension $\varnothing 3,5 \times 100\text{mm}$ "	Silicone 3m	$-50 \div 120^{\circ}\text{C}$ $-58 \div 248^{\circ}\text{F}$	
SPC10IA	PTC sensor, plastic handle, inox steel cap "dimension $\varnothing 3,5 \times 100\text{mm}$ "	Silicone for use with food 3m	$-50 \div 120^{\circ}\text{C}$ $-58 \div 248^{\circ}\text{F}$	
NPC10IA	NTC sensor, plastic handle, inox steel cap "dimension $\varnothing 3,5 \times 100\text{mm}$ "	Silicone for use with food 3m	$-50 \div 120^{\circ}\text{C}$ $-58 \div 248^{\circ}\text{F}$	

## Pt100 THERMORESISTORS

Thermoresistance (RTD) probes are suitable when a high precision and low response time is necessary. The operating range of the Pt100 sensor is from  $-70\div 500^{\circ}\text{C}$  ( $-94\div 932^{\circ}\text{F}$ ), the precision is according to standard IEC751.

PROBE	DESCRIPTION	CABLE	TEMP. RANGE	
PT6	General purpose, 3 wires, inox steel cap "dimension $\varnothing 6 \times 100\text{mm}$ "	PVC 2m	$-30\div 105^{\circ}\text{C}$ $-22\div 221^{\circ}\text{F}$	
PT6.S	Protected, 3 wires, inox steel cap "dimension $\varnothing 6 \times 100\text{mm}$ "	Silicone 2m	$-60\div 200^{\circ}\text{C}$ $-76\div 392^{\circ}\text{F}$	
PT6.F	Protected, 3 wires, inox steel cap "dimension $\varnothing 6 \times 100\text{mm}$ "	Vetrotex 2m	$-60\div 350^{\circ}\text{C}$ $-76\div 662^{\circ}\text{F}$	
PT310	Compact, with male connection, 2 wires, inox steel cap "dimension $\varnothing 3 \times 100\text{mm}$ "	Silicone 2m	$-70\div 500^{\circ}\text{C}$ $-94\div 932^{\circ}\text{F}$	
PT315	Compact, with male connection, 2 wires, inox steel cap "dimension $\varnothing 3 \times 150\text{mm}$ "	Silicone 2m	$-70\div 500^{\circ}\text{C}$ $-94\div 932^{\circ}\text{F}$	

## TC THERMOCOUPLES

Thermocouple (TC) probes are suitable when a short response time and high shock resistance are necessary. The operating range of the TCJ sensor is from  $0\div 600^{\circ}\text{C}$  ( $32\div 1112^{\circ}\text{F}$ ) and the range of the TCK is from  $0\div 1150^{\circ}\text{C}$  ( $32\div 2102^{\circ}\text{F}$ ), the precision is according to standard IEC584-2.

PROBE	DESCRIPTION	TEMP. RANGE	
TJ6	General purpose, protected, Fe-CO, cap "dimension $\varnothing 6 \times 100\text{mm}$ ", 2,0/3,0m vetrotex cable	$0\div 350^{\circ}\text{C}$ $32\div 662^{\circ}\text{F}$	
TK6	General purpose, protected, Cr-Al, cap "dimension $\varnothing 6 \times 100\text{mm}$ ", 2,0/3,0m vetrotex cable	$0\div 350^{\circ}\text{C}$ $32\div 662^{\circ}\text{F}$	
TJD215	DIN connector, Fe-CO, cap "dimension $\varnothing 2 \times 150\text{mm}$ "	$0\div 600^{\circ}\text{C}$ $32\div 1112^{\circ}\text{F}$	
TJD320	DIN connector, Fe-CO, cap "dimension $\varnothing 3 \times 200\text{mm}$ "	$0\div 600^{\circ}\text{C}$ $32\div 1112^{\circ}\text{F}$	
TKD215	DIN connector, Cr-Al, cap "dimension $\varnothing 2 \times 150\text{mm}$ "	$0\div 1150^{\circ}\text{C}$ $32\div 2102^{\circ}\text{F}$	
TKD320	DIN connector, Cr-Al, cap "dimension $\varnothing 3 \times 200\text{mm}$ "	$0\div 1150^{\circ}\text{C}$ $32\div 2102^{\circ}\text{F}$	
CMJ	Compensating female connector, Fe-CO, for TJD215 and TJD320	$-40\div 200^{\circ}\text{C}$ $-40\div 392^{\circ}\text{F}$	
CMK	Compensating female connector, Cr-Al, for TKD215 and TKD320	$-40\div 200^{\circ}\text{C}$ $-40\div 392^{\circ}\text{F}$	

## TEMPERATURE/HUMIDITY PROBES

Temperature/humidity probes for HVAC/R with DEW POINT calculation and RS485 output with ModBUS protocol. XH50P and XH55P are the ideal solution for anti-sweat heater control; these special probes, ideal for already existent plants, allow anti-sweat heater operation according to dew point conditions of the retail space. Through the correct calibration of Dixell algorithms, it is possible to obtain a proportional change of the operating voltage range of anti-sweat heaters, optimizing its consumption and increasing the energy saving on the average used power of the anti-sweat heaters.



- Available in 2 versions: **XH50P** (without knob), **XH55P** (with knob)
- LED to display the device status
- Wall mounting (503 box dim. compatible)
- Self extinguishing ABS housing

The XH50P and XH55P probes, depending on the actual needs, can be used stand-alone or in centralized applications combined with XM600 controllers for multiplexed cabinets and XWEB5000 supervising system.

### STAND-ALONE APPLICATION

- Based on the Dew Point estimate through the temperature and humidity measurement
- Thermostat control of anti-sweat heaters on a programmable value higher than the Dew Point
- Anti-sweat heaters control directly from XH

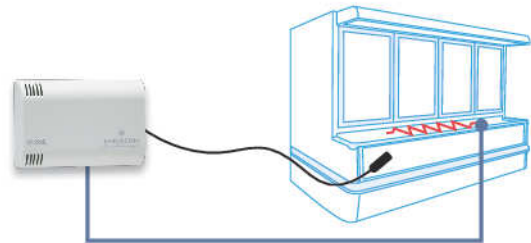

### CENTRALIZED MANAGEMENT

- Use of Dew Point sensors
- Management of anti-sweat heaters set point through Supervising
- Direct control of anti-sweat heaters from the counter controller
- Possibility to manage regulation parameters in groups

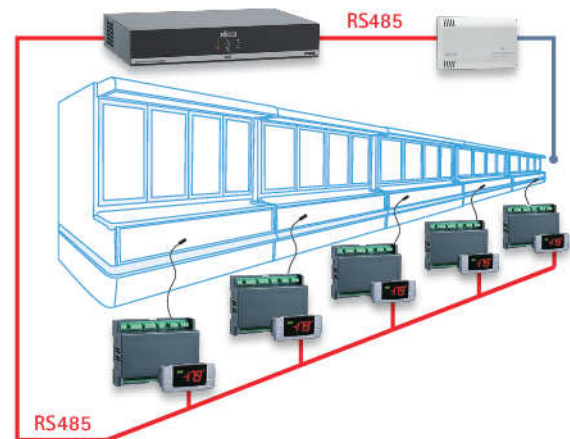

### HOW to ORDER

XH50/55P    X   H   5   P   -   0   N   C   D   E

C	D	E
Analog output	Measurement unit	Relay output
0 = No	C = °C	1 = 8A
1 = Yes	F = °F	2 = 16A

FEATURES	XH50P	XH55P
Knob		pres
Power supply	12÷24Vac/dc - 12÷40Vdc	12÷24Vac/dc - 12÷40Vdc
Remote probe input	NTC	NTC
Digital input	free of voltage	free of voltage
Configurable relay output	8A, 16A	8A, 16A
Hot Key output	pres	pres
Serial output	RS485	RS485
Analog output	0÷10V opt	0÷10V opt

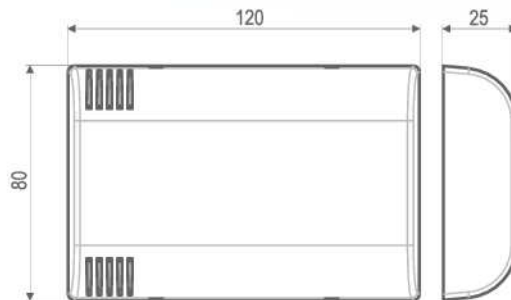
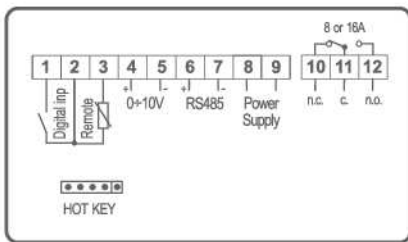

## HUMIDITY PROBES

XH10P and XH20P humidity probes are suitable for all those applications where it is necessary to detect and control humidity. Such applications are: refrigeration, drying processes and more. Depending on the model, they supply a standard output current (4÷20mA) or voltage (0÷10V) signal. The high accuracy, the appropriate lead time and the sensor reliability also in cases with condensation, make these probes extremely effective.

- Wall mounting
- Power consumption: 22mA max
- Protection: IP65
- Operating range: humidity 30÷90% for XH10P and 0÷99% for XH20P

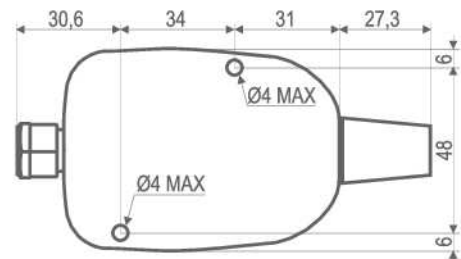

### HOW to ORDER

XH10/20P X H O P - O B O O O

B

#### Output

0 = 4÷20mA

1 = 4÷10Vdc

FEATURES	XH10P		XH20P	
Power supply	9÷18Vdc	15÷35Vdc - 12÷24Vac	9÷18Vdc	15÷35Vdc - 12÷24Vac
Output	4÷20mA	0÷10Vdc	4÷20mA	0÷10Vdc
Accuracy	±5%	±5%	±3%	±3%
Operating temperature	0÷60°C (32÷140°F)	0÷60°C (32÷140°F)	0÷70°C (32÷158°F)	0÷70°C (32÷158°F)
Storage temperature	-30÷85°C (22÷185°F)	-30÷85°C (22÷185°F)	-30÷85°C (22÷185°F)	-30÷85°C (22÷185°F)
Measurement range	30÷90%RH	30÷90%RH	0÷99%RH	0÷99%RH

## PRESSURE PROBES

### PRESSURE TRANSDUCERS

Pressure transducers supply a standard output current signal (4±20mA). The silicon sensor is assembled in a waterproof steel housing filled with oil that optimizes stable and constant measurement with additional protection against vibrations and a duration equivalent to millions of pressure cycles. The tip of the probe allows placement in contact with ammonia and various other kinds of corrosive gases.

<b>PP07</b>	2 wires transducer with 4±20mA output and measurement range -0,5÷7bar (male or female fitting)
<b>PP11</b>	2 wires transducer with 4±20mA output and measurement range -0,5÷11bar (male or female fitting)
<b>PP30</b>	2 wires transducer with 4±20mA output and measurement range 0÷30bar (male or female fitting)
<b>PP50</b>	2 wires transducer with 4±20mA output and measurement range 0÷50bar (male or female fitting)

### FEATURES

Power supply	8±28Vdc
Output	4±20mA
Protection	IP65
Operating temperature	-40÷135°C (-40÷275°F)
Storage temperature	-40÷135°C (-40÷275°F)
Accuracy	1% FS.

### RATIOMETRIC PRESSURE TRANSDUCERS

Pressure transducers supply a standard output ratiometric signal (0÷5V). The design is ideal for demanding HVAC and refrigeration applications where long term reliability is necessary. The electrical interface is a rugged industry-accepted connector. This device maintains accuracy through a wide range of temperatures.

<b>PPR15</b>	3 wires ratiometric transducer with 0÷5V output and measurement range 0÷15bar
<b>PPR30</b>	3 wires ratiometric transducer with 0÷5V output and measurement range 0÷35bar
<b>PPR45</b>	3 wires ratiometric transducer with 0÷5V output and measurement range 0÷45bar

### FEATURES

Power supply	4,5÷5,5Vdc
Output	0,5÷4,5Vdc
Protection	IP65
Operating temperature	-40÷135°C (-40÷275°F)
Storage temperature	-40÷135°C (-40÷275°F)
Accuracy	1,2% FS.



MALE FITTING

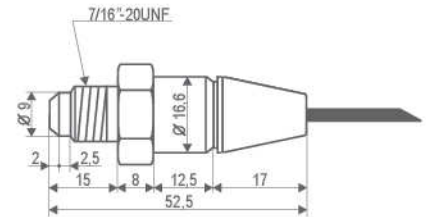

FEMALE FITTING

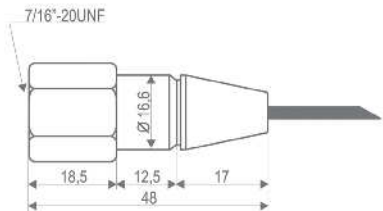

FEMALE FITTING

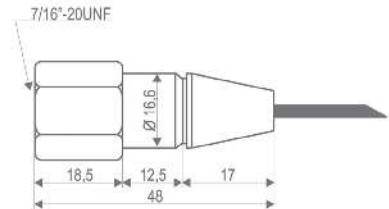





# ACCESSORIES

## SECTION INDEX



FUNCTIONS	MODELS	
<b>MODEM</b>		<b>154</b>
Modem and antenna	XWEB MODEM - TC35-KIT - XW-ANT	154
<b>ENERGY ANALYSERS</b>		<b>154</b>
Energy analysers	EM21D - EM23D-1P - EM23D-3P - WM14D - WM22D	154
Transformers for analysers	TA100-5 - TA200-5	155
<b>WIRING</b>		<b>155</b>
Ethernet patch cables	CAB/WEB/NET - CAB/WEB/PC	155
Wiring for XC600CX	CAB/CJ15 - CAB/CJ30 - CW15-KIT - CW25-KIT CWC15-KIT - CWC30-KIT	155
Wiring for XEV and iPro	DWXE30 - DWS30-KIT - DWEX306-30KIT - DWB30-KIT DWEX60-30KIT - DWX115-30KIT - DWEX70-30KIT - IP-FC108 IP-FC208 - IP-FC215CP - IP-FCEX60 - IP-FCX215 - IP-FCEX70 IP-FC500	155
<b>PROGRAMMING</b>		<b>156</b>
Programming tool	WIZMATE PROG-TOOL KIT - XJ485USB-KIT	156
Programming keys	HOT KEY - HOT KEY 128 - VISOKEY - PROG KEY	157
<b>GATEWAY</b>		<b>157</b>
Gateway for M-Bus meters	i-METER	157
<b>REMOTE DISPLAY</b>		<b>157</b>
Remote display	X-REP	157
Cables for remote display	CAB/REP1 - CAB/REP3 - CAB/REP5 - CAB51F - CAB52F CAB55F	157
<b>VARIOUS</b>		<b>158</b>
Printer	XB07PR	158
Adapters	C-BOX - C-BOX2 - VS-BOX - VS-BOX2 - V-KIT/W V-KIT/B - FA64 - FA/CX	158
Filters	FT-IL - FT-PW	158
Gaskets and protections	MDP/CX - RG-C - RG-L - RG-LX - RG-V - PG-L	159
Fixing systems	PM-WL - PM-WLT - XW-WA	159
Transformers	TF3 - TF5 - TF10 - TF10D - TF20D - TF40D	159
Light switches	LS-R - LS-G - LS-Y - CXLS-R - CXLS-G - CXLS-Y - WLS-R WLS-G - WLS-Y	160
Cables	CAB/KB11 - CAB/USB10 - CAB/HK - CAB/485-TGIPG	160
Connectors	XM-FC16 - XM-FC21 - XM-FC26	160
Serial interface	XJ485CX	160
USB converter	USB-ETH-CONV	160
Clock board	XM-RTC	161
Batteries	BA6H - BA24H	161
Anti-condensing kit	XV-ACK	161
Power suppliers	PW-DL - TF-TGIPG - PW200J	161
USB key	XDL-KEY	161
Relay	T92	161
Simulators	KIT SIMULATORE IPG108 - KIT SIMULATORE IPG115D	161



## ACCESSORIES



### MODEM



#### MODEM and ANTENNA

<b>XWEB MODEM</b>	For XWEB, IPG115 and IPG215	Analogue serial modem PDA compatible, 56kbps (DIN Rail format) HOW to ORDER: XWEBMODEM-200 (with 24Vac power supply) XWEBMODEM-400 (with 110Vac power supply) XWEBMODEM-500 (with 230Vac power supply)	
<b>TC35-KIT</b>	For XWEB300D/500D, XWEB500, IPG115 and IPG215	GSM modem kit containing the modem, the power supply unit, the transmitting antenna with the relevant cable and the connection to controlling system	
<b>XW-ANT</b>	For XWEB300D/500D and IPL500D	GSM/GPRS antenna with magnetic base and 2,5m cable	

### ENERGY ANALYSERS

#### ENERGY ANALYSERS

<b>EM21D</b>	Single/three-phase energy meter, CT-connected (5A), RS485 output. Self power supply. Dimensions: 71,7x71,7x64,6mm. DIN Rail or panel mounting. Housing: ABS self-extinguishing. Operating temperature: -25÷55°C (-13÷131°F). Relative humidity < 90%	
<b>EM23D-1P</b>	Single-phase energy meter, direct connected with integrated current transformers, with RS485 output. Current inputs 10(65)A, voltage 230VLN. Self power supply. Dimensions: 71,6x90x66,3mm. DIN Rail mounting. Housing: ABS self-extinguishing. Operating temperature: -25÷55°C (-13÷131°F). Relative humidity < 90%	
<b>EM23D-3P</b>	Three-phase energy meter, direct connected with integrated current transformers, with RS485 output. Current inputs 10(65)A, voltage 230VLN. Self power supply. Dimensions: 71,6x90x66,3mm. DIN Rail mounting. Housing: ABS self-extinguishing. Operating temperature: -25÷55°C (-13÷131°F). Relative humidity < 90%	

<b>WM14D</b>	Three-phase power analyser, with RS485 output. 90÷260Vac power supply. Dimensions: 107,5x90x63mm. DIN Rail and wall mounting. Housing: ABS self-extinguishing. Operating temperature: 0÷55°C (32÷131°F). Relative humidity < 90%	
<b>WM22D</b>	Single/three-phase power analyser 400Vac, with RS485 output. 230Vac power supply. Dimensions: 162,5x90x63mm. DIN Rail and wall mounting. Housing: ABS self-extinguishing. Operating temperature: 0÷55°C (32÷131°F). Relative humidity < 90%	

## TRANSFORMERS for ANALYSERS



<b>TA100-5</b>	Current transformer to use with EMD21D and WM14D controllers. DIN Rail, bus-bar and wall mounting. Primary winding current 100A. Secondary winding current 5A	
<b>TA200-5</b>	Current transformer to use with EMD21D and WM14D controllers. DIN Rail, bus-bar and wall mounting. Primary winding current 200A. Secondary winding current 5A	

## WIRING



### ETHERNET PATCH CABLES

<b>CAB/WEB/NET</b>	For iPro and XWEB	Ethernet patch cable, 3m	
<b>CAB/WEB/PC</b>	For iPro and XWEB	Ethernet patch cross over cable, 1m	

### WIRING for XC600CX

<b>CAB/CJ15</b>	For XC645CX, XC650CX and XC652CX	Connector with 1,5m wires for HP, DI inputs and analog outputs	
<b>CAB/CJ30</b>	For XC645CX, XC650CX and XC652CX	Connector with 3m wires for HP, DI inputs and analog outputs	
<b>CW15-KIT</b>	For XC650CX and XC652CX	2 disconnectable female connectors, 12-14 pins with wires 1,5m	
<b>CW25-KIT</b>	For XC650CX and XC652CX	2 disconnectable female connectors, 12-14 pins with wires 2,5m	
<b>CWC15-KIT</b>	For XC645CX	2 disconnectable female connectors, 6-14 pins with wires 1,5m, for models with internal triac	
<b>CWC30-KIT</b>	For XC645CX	2 disconnectable female connectors, 6-14 pins with wires 3m, for models with internal triac	



### WIRING for XEV and iPro

<b>DWXEV30</b>	For XEV20D	1 disconnectable female connector, 12 pins with wires 3m	
<b>DWS30-KIT</b>	For IPG108D and IPG108E	2 disconnectable female connectors, 12-16 pins with wires 3m	
<b>DWEX306-30KIT</b>	For IPX306D	2 disconnectable female connectors, 10-16 pins with wires 3m	
<b>DWB30-KIT</b>	For IPG115D	3+3 disconnectable female connectors, 6-8-10 pins and 10-16-22 pins with wires 3m	
<b>DWEX60-30KIT</b>	For IPX106D	1+2 disconnectable female connectors, 8 and 10-16 pins with wires 3m	



<b>DWX115-30KIT</b>	For IPX115D	3+3 disconnectable female connectors, 6-8-10 pins and 10-16-22 pins with wires 3m	
<b>DWEX70-30KIT</b>	For IPX125D	5+3 disconnectable female connectors, 6-6-8-8-10 pins and 10-16-22 pins with wires 3m	
<b>IP-FC108</b>	For IPG108D and IPG108E	1+1 screw female connectors, 7 and 12 pins	
<b>IP-FC208</b>	For IPG208D, IPG208E and IPR208D	1+1 screw female connectors, 7 and 12 pins and 2 bayonet female connectors 12-16 pins	
<b>IP-FC215CP</b>	For IPG215D, IPG215F and IPR215D	6 screw female connectors, 2-3(x2)-6-7-8 pins and 3 bayonet female connectors 10-16-22 pins	
<b>IP-FCEX60</b>	For IPX206D	1 screw female connector, 12 pins and 2 bayonet female connectors 10-16 pins	
<b>IP-FCX215</b>	For IPX215D	6 screw female connectors, 2-3(x2)-6-7-8 pins and 3 bayonet female connectors 10-16-22 pins	
<b>IP-FCEX70</b>	For IPX225D	9 screw female connectors, 2-3(x3)-5-6(x2)-7-8 pins and 3 bayonet female connectors 10-16-22 pins	
<b>IP-FC500</b>	For IPL500D	2 screw female connectors 2-9 pins	

## PROGRAMMING

### PROGRAMMING TOOL



<b>WIZMATE PROG-TOOL KIT</b>	<p>Programming kit made up of CD and DIN RAIL module (PROG-TOOL) with connections for Hot Key and RS485 for Dixell instruments; it allows the user to connect controllers to a PC running Windows 2000/XP OS. The CD-rom includes: WIZMATE (to program an instrument or a Hot Key). The Kit includes: the CAB/PTK2 wire for DIN module instrument connection, the CAB/PTK485 wire for DIN module RS485 (built-in) instrument connection, the RS232-USB-CONV converter for PC connections</p> <p>HOW to ORDER:  WIZMATE PROG-TOOL KIT 110V (with 110Vac power supply)  WIZMATE PROG-TOOL KIT 230V (with 230Vac power supply)</p>	
<b>XJ485USB-KIT</b>	<p>The USB to RS485 serial converter (2 wires) is the perfect choice to interface any computer, equipped with WIZMATE® software and a USB port, to a network of instruments. XJ485USB is only 78x40x22mm and supports different communication speeds in the range from 300 to 19200bps. The kit includes the USB cable type A-B, 1,5m and a USB with the drivers for the main operative systems (Microsoft Windows, Linux, MAC OS) and a WIZMATE® software version</p>	

## PROGRAMMING KEYS

<b>HOT KEY</b>	Key for a quick and easy Dixell's controllers programming. Dimensions 0,8x16x46mm	
<b>HOT KEY 128</b>	Key for a quick and easy XB570L controller programming. Dimensions 0,8x16x46mm	
<b>VISOKEY</b>	Programming key for Visograph keyboard. Dimensions 0,8x16x46mm	
<b>PROG KEY</b>	Programming key for firmware update. Dimensions 0,8x16x46mm	

## GATEWAY

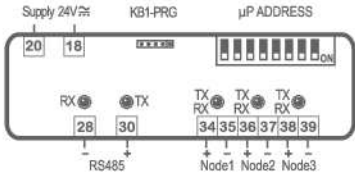
### GATEWAY for M-BUS METERS

<b>i-METER</b>	<p>M-Bus - ModBUS-RTU Slave protocol converter, used to centralize and read the consumption data of the energy meters (electricity, gas or water). i-METER is ideal for monitoring energy consumption and control of system leaks.</p> <p>Housing: 8 DIN Protection: IP50 Connections: screw terminals Power supply: 24 Vac/dc <math>\pm</math> 10% N° of nodes that can be connected: max 3 Certified models: ISTA (Istameter, Domaqua, Sensonic II)</p>	 
----------------	---	--

## REMOTE DISPLAY

### REMOTE DISPLAY

<b>X-REP</b>	<p>Remote display for temperature reading to be used with compatible Dixell's controllers. The front panel is IP65 and makes the installation easy wherever the controlled temperature needs to be displayed. Display: n° digits <math>\pm</math> 3 d.p. Power Supply: from the controller HOW to ORDER: X-REP-00000 X-REP-10000 (for XJA, XJP)</p>	
--------------	---	---

### CABLES for REMOTE DISPLAY

<b>CAB/REP1</b>	Multipolar connector for X-REP, 1m; to use with WING, XM, XB series	
<b>CAB/REP3</b>	Multipolar connector for X-REP, 3m; to use with WING, XM, XB series	
<b>CAB/REP5</b>	Multipolar connector for X-REP, 5m; to use with WING, XM, XB series	
<b>CAB51F</b>	Cable for X-REP, 1m; to use with XJA, XJP and PRIME CX series	
<b>CAB52F</b>	Cable for X-REP, 2m; to use with XJA, XJP and PRIME CX series	
<b>CAB55F</b>	Cable for X-REP, 5m; to use with XJA, XJP and PRIME CX series	

## VARIOUS

### PRINTER

<p><b>XB07PR</b></p>	<p>Compact thermal printer designed for connection to the XB570L controller. It provides a hard copy print out of the cycles. Paper width 58mm. EASYLOCK fixing system that allows to adapt the printer to the panel thickness without further supports. Operating Voltage range: 3.5÷8V. Dimensions: 85.5x85x55mm</p>	
----------------------	--	---



### ADAPTERS

<p><b>C-BOX</b></p>	<p>Wall adapter for C and CX format controllers, IP55, dimensions: 108x108x90mm</p>	
<p><b>C-BOX2</b></p>	<p>Wall adapter for C and CX format controllers, IP55, dimensions: 170x105x82mm</p>	
<p><b>VS-BOX</b></p>	<p>Wall adapter for VS format controllers, IP55, dimensions: 135x74x72mm</p>	
<p><b>VS-BOX2</b></p>	<p>Wall adapter for VS format controllers, IP55, dimensions: 170x105x82mm</p>	
<p><b>V-KIT/W</b></p>	<p>Wall adapter for vertical keyboards, IP55, dimensions: 100x64x43mm, white colour</p>	
<p><b>V-KIT/B</b></p>	<p>Wall adapter for vertical keyboards, IP55, dimensions: 100x64x43mm, black colour</p>	
<p><b>FA64</b></p>	<p>Frame adapter for smaller 31x64mm models to fit larger 32x74mm instrument cut outs</p>	
<p><b>FA/CX</b></p>	<p>Multifunction frame adapter from L to CX format controllers with the possibility to mount up to 2 CXLS light switches</p>	



### FILTERS

<p><b>FT-IL</b></p>	<p>Inductive load filter 0,1µF/1000hm 250V</p>	
<p><b>FT-PW</b></p>	<p>Line filter</p>	



## GASKETS and PROTECTIONS

MDP/CX	Plastic protection for C and CX formats against dripping on terminal blocks	
RG-C	Front panel rubber gasket for C format, IP65 mounting	
RG-L	Front panel rubber gasket for L format (STANDARD), IP65 mounting	
RG-LX	Front panel rubber gasket for L format (INOX), IP65 mounting	
RG-V	Front panel rubber gasket for V format, IP65 mounting	
PG-L	Plastic multipurpose protection for L format, IP65	

## FIXING SYSTEMS

PM-WL	Patented fixing system (Design Patent: UAMI n. 001851916-0001) for a simple and easy to mount solution suitable for any metallic flat surface for WING-L INOX and BACK-PANEL controllers with polycarbonate. The kit is composed of one adhesive bracket and counter plastic bracket	
PM-WLT	Patented fixing system (Design Patent: UAMI n. 001851916-0001) for a simple and easy to mount solution suitable for any metallic flat surface for WING-L TOUCH controllers. The kit is composed of one adhesive bracket and counter plastic bracket	
XW-WA	Wall mounting bracket for XWEB500	





## TRANSFORMERS

TF3	The TF3 3VA model is available in the following versions: 230/12Vac, 110/12Vac and 24/12Vac. Others models with internal thermofuse (130°C) and UL, CSA, VDE approval are available	
TF5	The TF5 5VA model is available in the following versions: 230/12Vac, 110/12Vac and 24/12Vac	
TF10	The TF10 10VA model is available in the following versions: 230/12Vac, 110/12Vac and 24/12Vac	
TF10D	The TF10D (DIN Rail mounting) 10VA model is available in the following versions: 230/24Vac and 110/24Vac. 2 DIN Rail format	
TF20D	The TF20D (DIN Rail mounting) 20VA model is available in the following versions: 230/24Vac and 110/24Vac. 3 DIN Rail format	
TF40D	The TF40D (DIN Rail mounting) 40VA model is available in the following versions: 230/24Vac and 110/24Vac. 4 DIN Rail format	

## LIGHT SWITCHES

LS-R	Red light switch 16A/250Vac	
LS-G	Green light switch 16A/250Vac	
LS-Y	Yellow light switch 16A/250Vac	
CXLS-R	Red light switch 16A/250Vac for FA/CX	
CXLS-G	Green light switch 16A/250Vac for FA/CX	
CXLS-Y	Yellow light switch 16A/250Vac for FA/CX	
WLS-R	Red light switch 16A/250Vac for WING Series	
WLS-G	Green light switch 16A/250Vac for WING Series	
WLS-Y	Yellow light switch 16A/250Vac for WING Series	

## CABLES

CAB/KB11	1m cable to connect the keyboard and the XEV driver or the XJA-XJP-XJR modules	
CAB/USB10	USB extended cable, 1m with plastic cap for XW737K and XW777K	
CAB/HK	Adapter cable, 5 pins for Hot Key input, 0,5m for XC10CX and XC30CX	
CAB/485-TGIPG	Cable for RS485 connection with connector for TGIPG	

## CONNECTORS

XM-FC16	Female connector kit, 16 pins for XM660K and XM670K	
XM-FC21	Female connector kit, 21 pins for XM669K and XM679K	
XM-FC26	Female connector kit, 26 pins for XM668K and XM678K	

## SERIAL INTERFACE

XJ485CX	The serial interface converts the TTL output into an RS485 signal that can be used to connect the unit to the controlling and supervising system. Dimensions: 1,6x16x46mm. Multipolar connector included, 0,2m	
---------	--	---

## USB CONVERTER



USB-ETH-CONV	USB-Ethernet adapter for iPro programmable controllers in 4 DIN Rail format	
--------------	---	---



## CLOCK BOARD

XM-RTC	Standard clock board for XM series	
--------	------------------------------------	---



## BATTERIES

BA6H	Battery for XJDL40D of 1.2Ah 6 hours of backup	
BA24H	Battery for XJDL40D of 4.0Ah 24 hours of back-up	

## ANTI-CONDENSING KIT

XV-ACK	Anti-condensing kit for XV110K and XV150K models	
--------	--	---

## POWER SUPPLIERS

PW-DL	Power supplier (24, 230Vac) for XDL01 module (with CAB/DL2 cable, 2m included) that works as a gateway between the XDL01 and Dixell instruments equipped with TTL or RS485 serial output HOW to ORDER: PW-DL-20000 (for 24Vac) PW-DL-50000 (for 230Vac)	
TF-TGIPG	Power supplier 24Vdc/1A for TGIPG	
PW200J	Power supplier for XJ200 modules with TTL-RS485 converter	

## USB KEY

XDL-KEY	USB key for XDL01, XW737K and XW777K	
---------	--------------------------------------	---

## RELAY

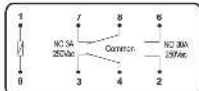
T92	Relay with a 30A current (3 HP/240Vac or 1HP/110Vac) suitable for all those applications where the load current is higher than the rating value of the relays mounted on the instruments. Contacts: 2C/O - 2N/O. Rated current: 30/3 (NO/NC). Rated/max. voltage: 250/480Vac. Rated breaking capacity: 7500VA. Nominal coil voltage: 240Vac. Nominal coil power: 1.7W/4VA. Coil contact: fast-on: 8mm. Dimensions: 30,5x52,3x34,6mm. Ambient temperature: -40±65°C (-40±149°F)	 
-----	--	---

## SIMULATORS

KIT SIMULATORE IPG108	Simulator of inputs and outputs is suitable to test the applications developed for the IPG108 programmable controllers. Thanks to a resistant aluminum frame, its compact dimensions 560x340x85mm, a complete series of wirings and versatile enclosure, it can be utilized in every situation. The simulator has a 230Vac power supply	
KIT SIMULATORE IPG115D	Simulator of inputs and outputs is suitable to test the applications developed for the IPG115 programmable controllers. Thanks to a resistant aluminum frame, its compact dimensions 560x340x85mm, a complete series of wirings and versatile enclosure, it can be utilized in every situation. The simulator has a 230Vac power supply	

# DIMENSIONS & CUT OUT

## CX, KEYBOARDS (32x74) - panel mounting

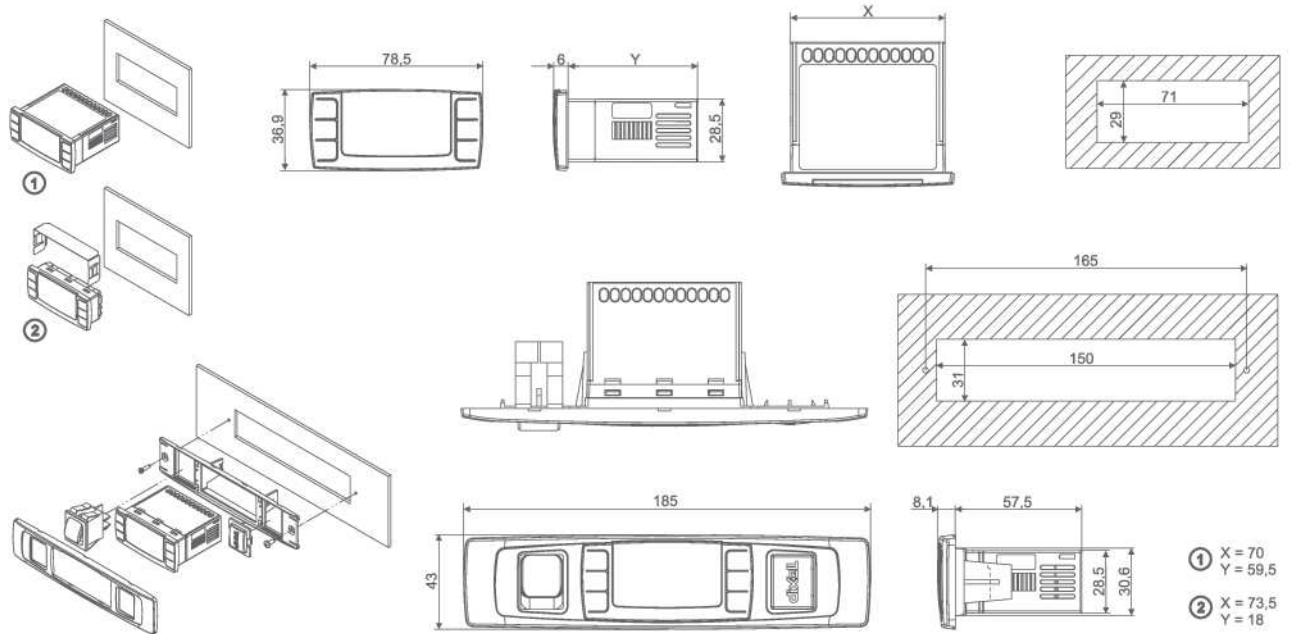

## C (32x74) - panel mounting

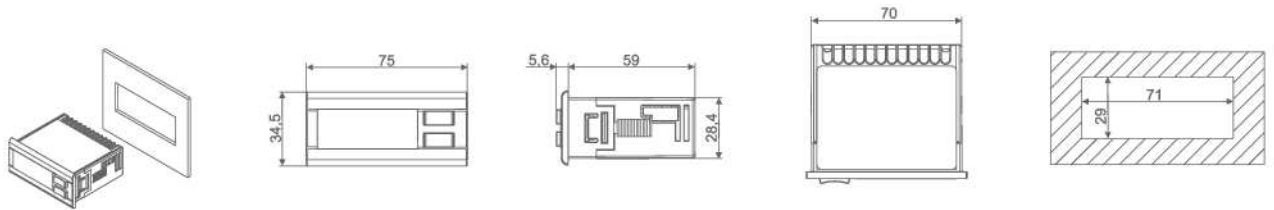

## XT11S, X-REP (31x64) - panel mounting

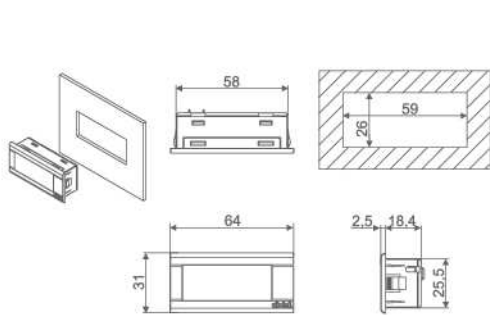

## 8 DIN (DIN RAIL) - wall or DIN Rail mounting

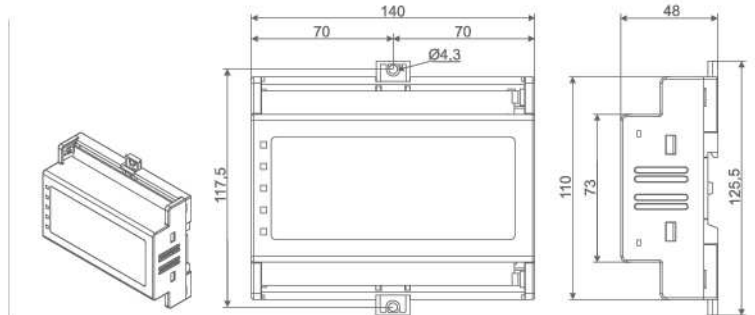

## 4, 10 DIN (DIN RAIL) - wall or DIN Rail mounting

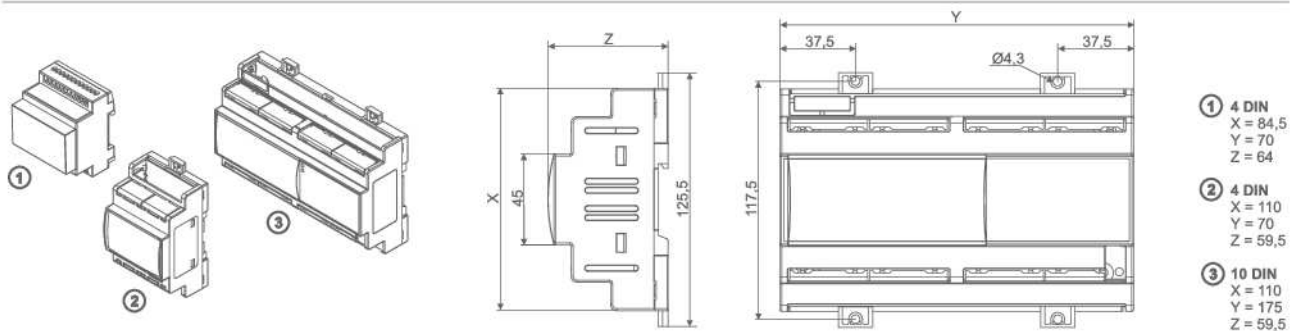

Size in mm

# L(T), LR(T), KEYBOARDS (38x185) – panel mounting

**WING STANDARD, INOX, TOUCH**  
front mounting with screws

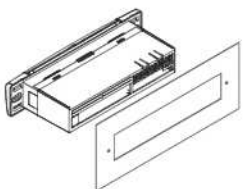

**WING INOX, POLYCARBONATE**  
back-panel mounting with captive screws and PG-L optional

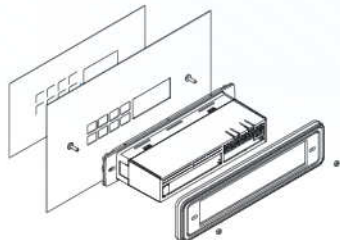

**WING INOX, TOUCH, POLYCARBONATE**  
back-panel mounting with PM-WL(T)

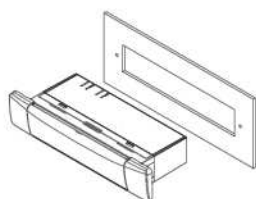
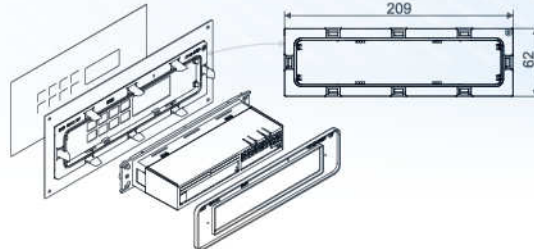

WING STANDARD

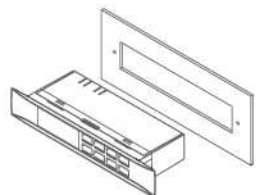
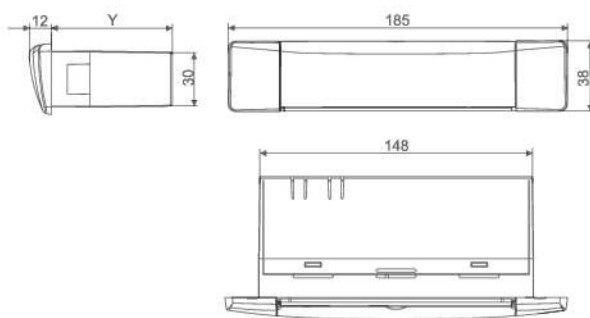
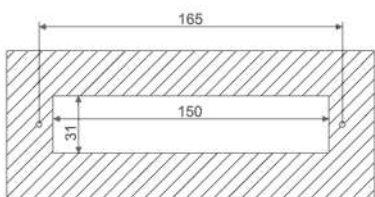

WING INOX

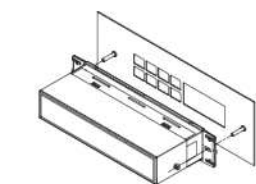
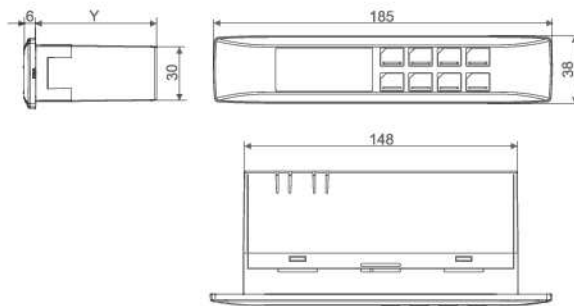
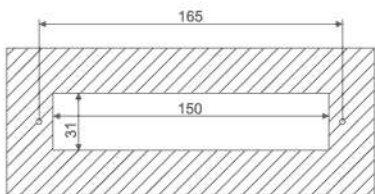

WING INOX/POLYCARBONATE

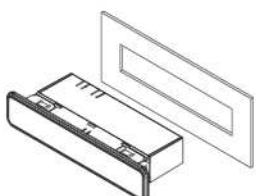
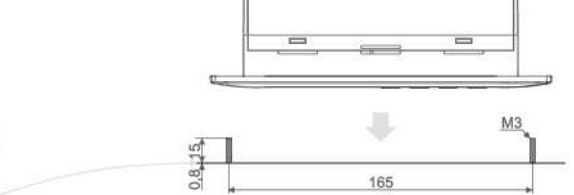
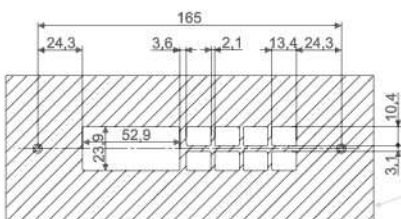

WING TOUCH

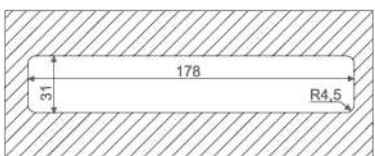
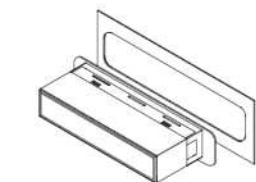
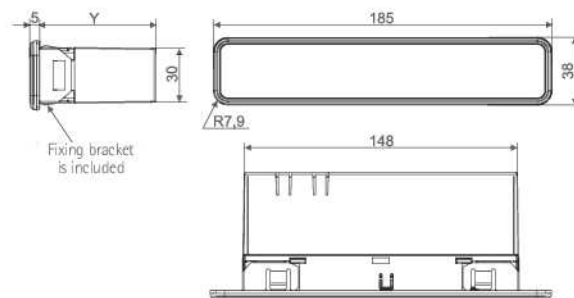
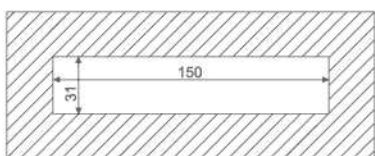

L(T) Y = 65

LR(T) Y = 40

KEYBOARD Y = 23

Size in mm

**V, VS, KEYBOARDS (100x64) - panel mounting**

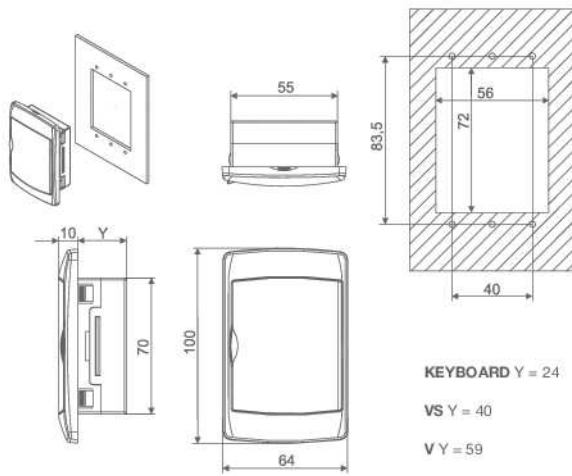

**V-KIT (100x64) - wall mounting**

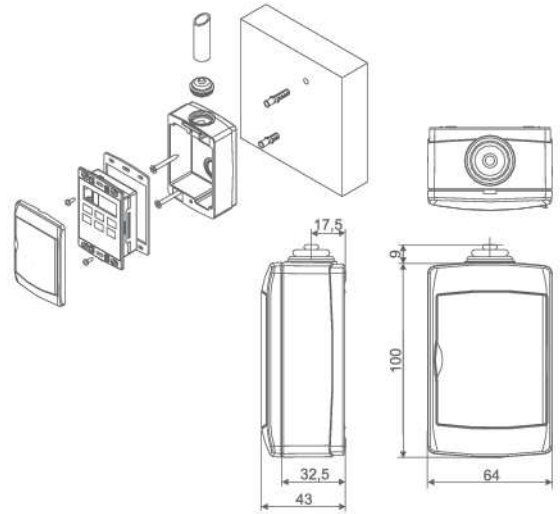

**C-BOX (108x108) - wall mounting**

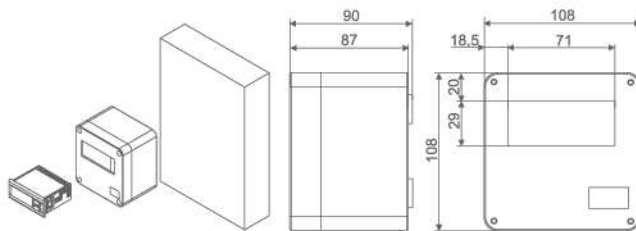

**VS-BOX (135x74) - wall mounting**

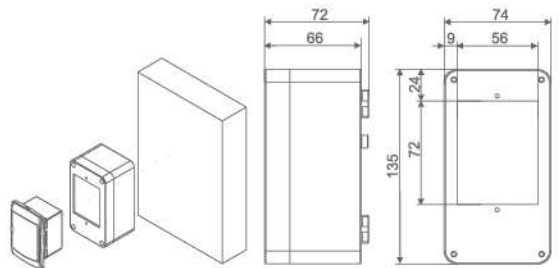

**C-BOX2 (170x105) - wall mounting**

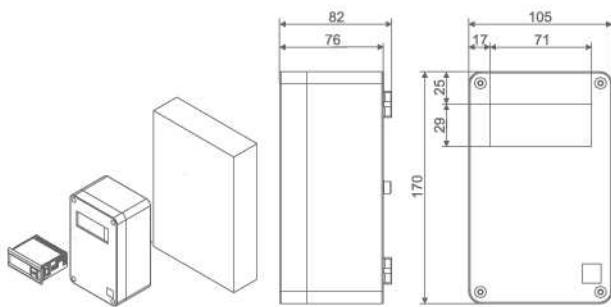

**VS-BOX2 (170x105) - wall mounting**

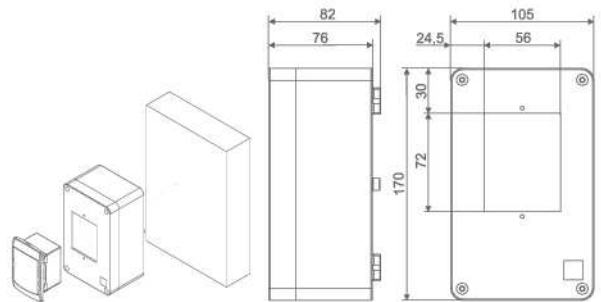

**XV110K (139x158)**

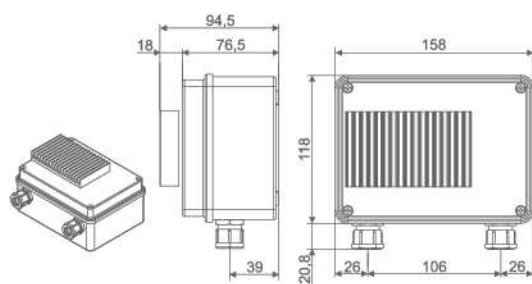

**XV150K (175x200)**

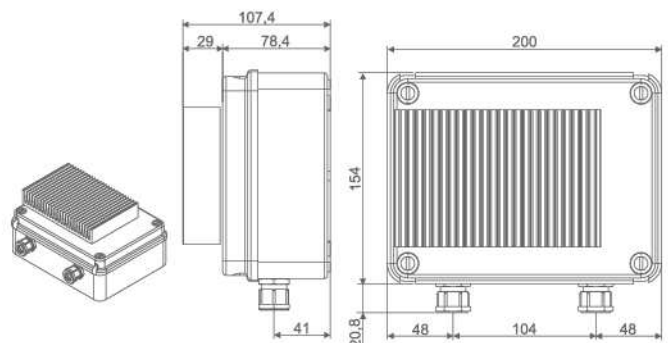

Size in mm

## PK (80x70) - panel mounting

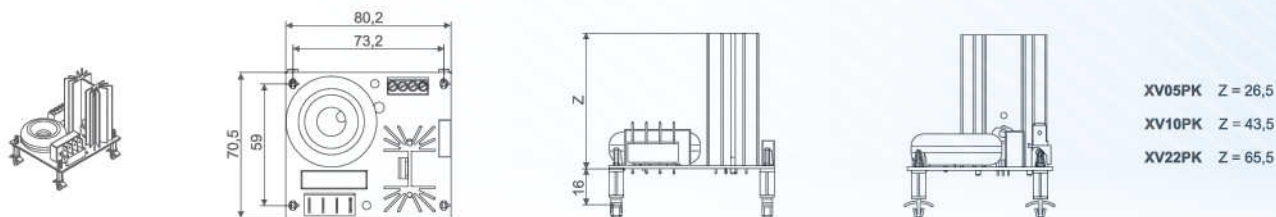

## XV300K - wall mounting

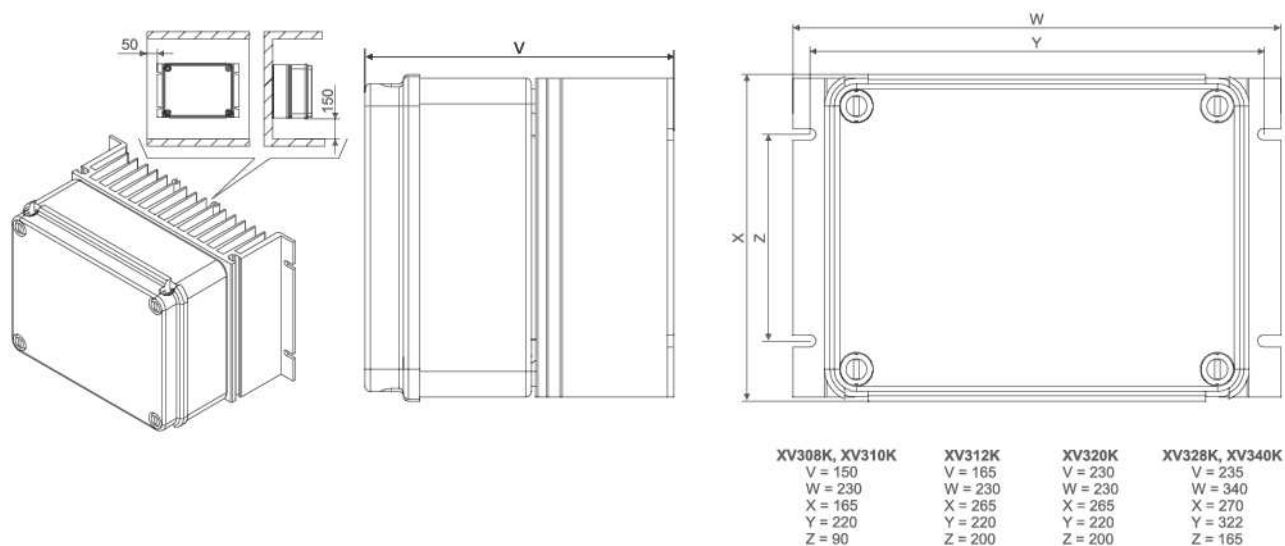

## VISOGRAPH (82x156) - wall or panel mounting

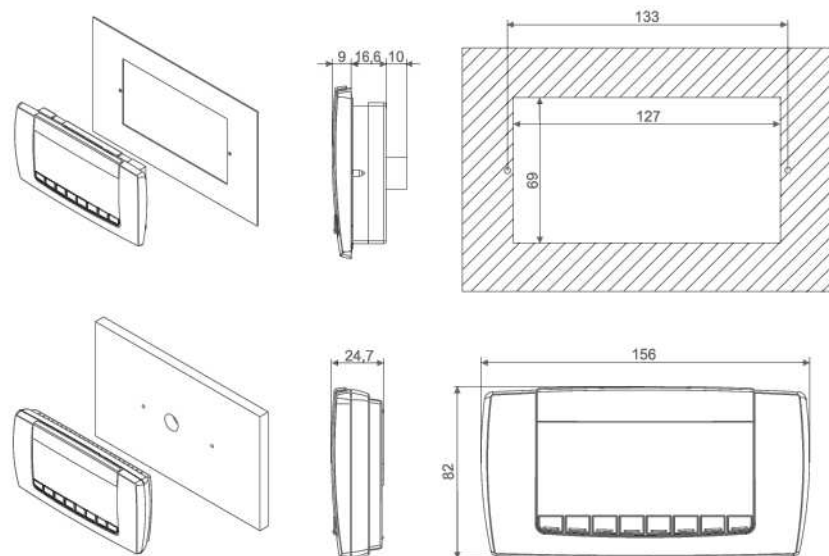

## XDL (45x70) - wall mounting

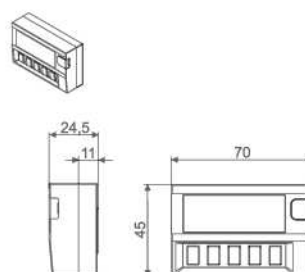

Size in mm

**XLR, XLH, XWEB500 (230x210) - wall or panel mounting**

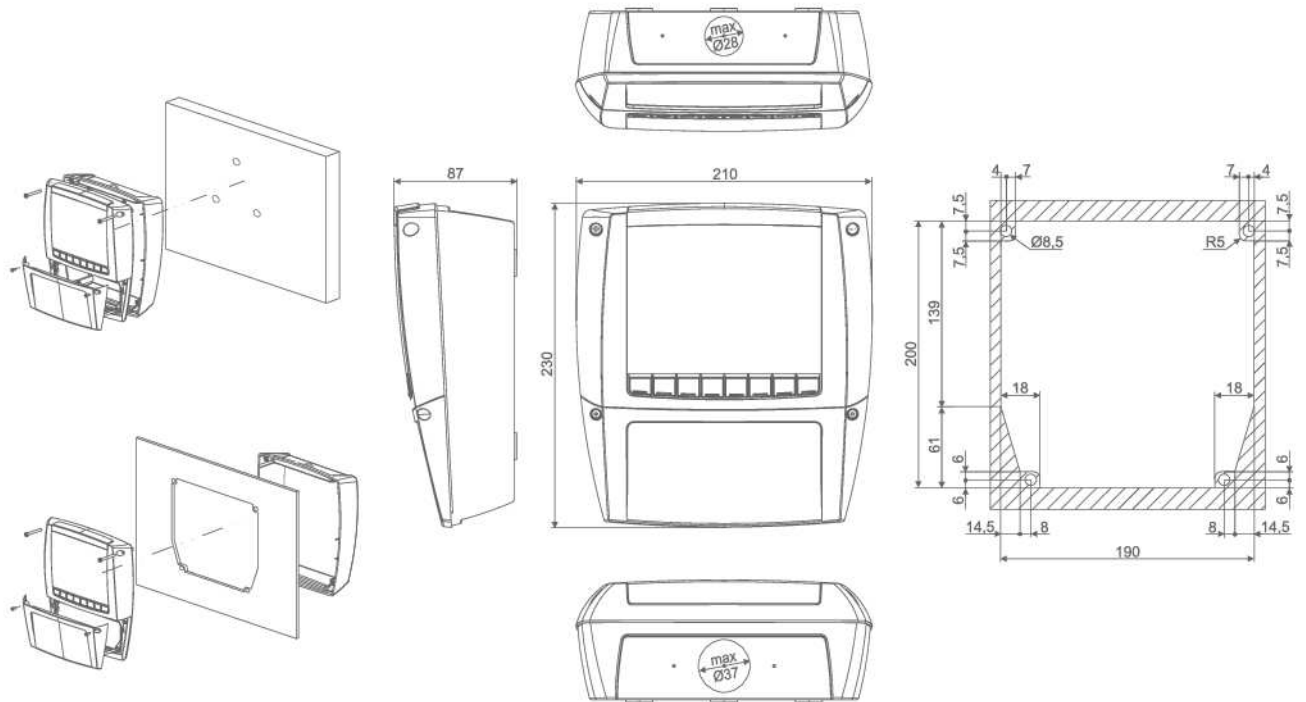

**XWEB3000, XWEB5000 (370x238) - 19" RACK mounting**

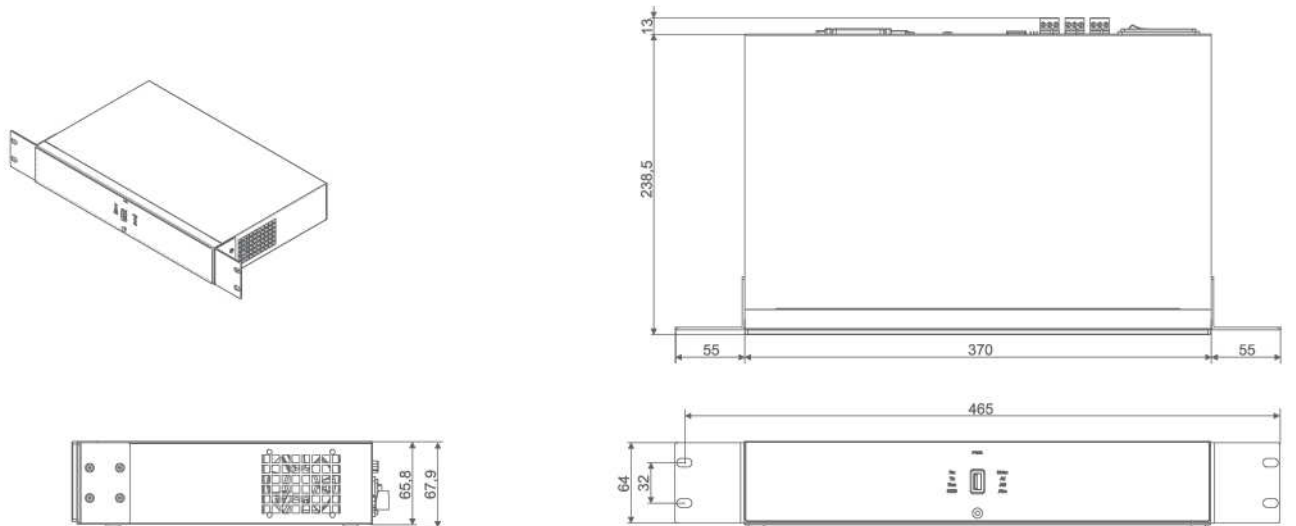

**XJ200 (80x80) - wall or pipemount or shelves mounting**

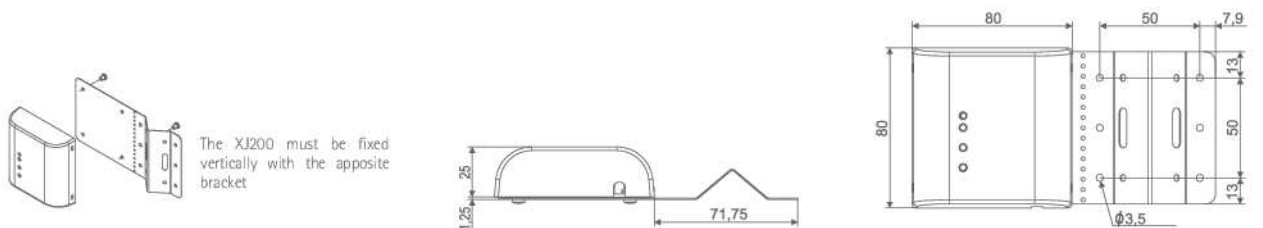

Size in mm

## TGIPG - panel mounting

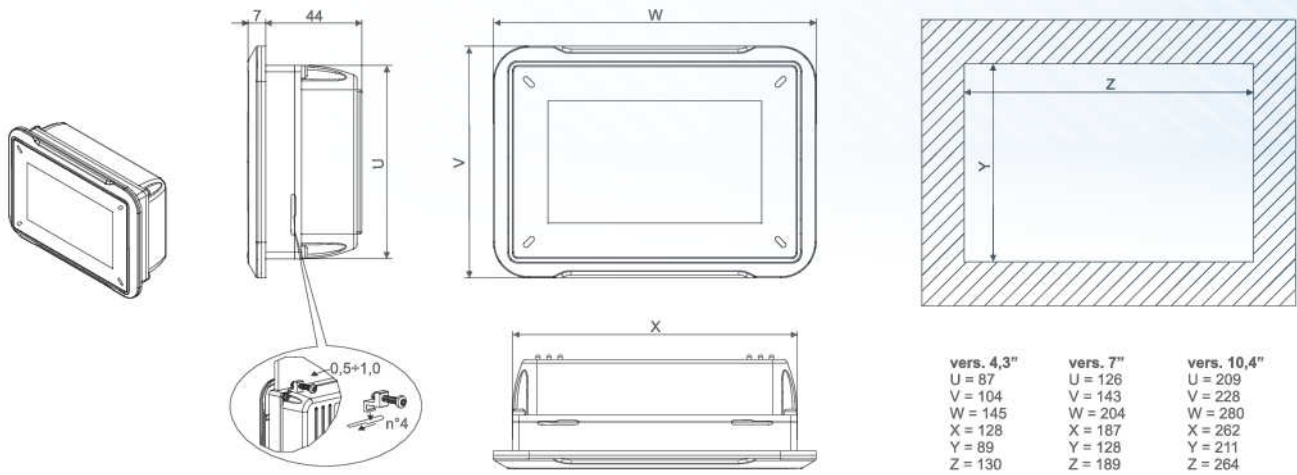

Size in mm

## GENERAL TECHNICAL FEATURES

The following technical features are ordinary for the products present in this catalogue, other main features can be found on the preliminary section of the series.

### Housing

self extinguishing ABS

### Front protection (with gasket, if available)

S format ⇒ IP65  
 C, CX formats and CX keyboards ⇒ IP65  
 L(T), LR(T) formats and WING horizontal keyboards ⇒ IP65  
 V, VS formats and WING vertical keyboards ⇒ IP65  
 XLR, XLH formats ⇒ IP65  
 4, 8, 10 DIN formats ⇒ IP20  
 VG format ⇒ IP65  
 XDL ⇒ IP30  
 TGIPG ⇒ IP65  
 XJ200 ⇒ IP30

### Accuracy

better than 1% of F.S.

### Data storage

EEPROM memory

### Operating temperature

0÷60°C (32÷140°F)

### Storage temperature

-30÷85°C (22÷185°F)

### Relative humidity

20÷85%

### Resolution

0,1°C or 1°F

All trademarks are property of their respective owners.

Dixell reserves the right to alter its products without notice. All rights reserved.

Because environmental conditions are outside of Dixell's control, we cannot assume liability for results obtained or any damages which may occur due to improper application.

Manuals and updates are available on our Web Site [www.dixell.com](http://www.dixell.com).

